



Catálogo de las
COCINAS - FOGONES
distribuidas en España

Este catálogo agrupa toda la información disponible sobre las **Cocinas - Fogones** que se distribuyen en España, según la facilitan sus respectivos fabricantes. Esta información incluye productos, modelos, características técnicas y precios.

Los precios indicados en este catálogo son los *Precios de Venta Recomendados* por cada fabricante, que puede haberlos actualizado, dejándolos obsoletos. Consúltenos el precio actual.

En todo caso, en la tienda online **Hostelería10.com** mejoramos con **grandes descuentos** los precios de todos los productos incluidos en este catálogo.

Las marcas de la sección **Cocinas - Fogones** que forman parte de este catálogo son:

- Arilex
- Ascaso
- Casfri
- Dosilet
- Edenox
- Fainca
- Fred
- Granita
- Jemi
- Mareno
- Masamar
- Repagas
- Romag
- Tecnoinox / Crystal Line

Solo una cuidada selección de los mejores productos de este catálogo están incluidos en **Hostelería10.com**.

Si tiene alguna duda respecto a alguno de estos productos o no encuentra el que busca, escribanos a contacto@hosteleria10.com o llámenos al **91 161 03 04**.

Estaremos encantados de atenderle.

Cocinas a Gas Gas Stoves

Cocinas a Gas Sobre mostrador Gas Stoves Countertop



Fabricado en España con materiales de alta calidad. Certificado CE.
Made in Spain with high quality materials. CE certified.

Construido en acero inoxidable acabado satinado de espesor 0,8 mm.
Built in satin finish stainless steel 0.8 mm thick.

40CG



80CG



120CG



Características Técnicas Technical Features

Modelo Model	Válvulas Valves	Quemadores Burners	Potencia (Kw) Power (Kw)	Superficie útil (AxF) mm. Usable area (LxW) mm.	Dimensiones (AxFxH) mm. Dimensions (LxWxH) mm.	Peso (Kg) Weight (Kg)	PVP (EUR)
40CG	1	1	6	400x400	410x457x240	10	409
80CG	2	2	6 + 6	800x400	810x457x240	20	716
120CG	3	3	6 + 6 + 6	1200x400	1210x457x240	30	1023
40PL	Placa de acero laminado de 6 mm. con peto 36 mm.						50
40GR	Bandeja Recogegrasas						29



Fogón con termopar de gran poder calorífico de 6 Kw. Parrilla de acero pavonado de gran dureza totalmente desmontable para limpieza.

High calorific 6Kw stove with thermocouple. Blued steel grill very hard and completely removable for cleaning.



Posibilidad de convertir cualquier fogón en plancha colocando una placa de acero laminado de 6 m. con peto sobre el fogón. Girando simplemente la parrilla encaja perfectamente una placa de 40x40 cm.

Ability to convert a kitchen stove in a gas plate placing a steel plate 6 mm. overall on the stove. Simply turning the grill plate fits 40x40 cm.



Mandos de baquelita de gran calidad con marcador de máximo/mínimo.

High quality bakelite controls with maximum/minimum marks.



Grasera opcional de acero inoxidable de gran capacidad para colocarse en parte trasera o frontal.

Optional stainless steel large capacity fat collector that can be used placed in back or front.



Encendido automático por piezoeléctrico (1 por válvula de gas).

Auto power piezoelectric (1 gas valve).



Pies altos regulables de gran robustez.

Robust adjustable feet.



Toma de gas por la parte trasera que facilita la instalación en sitios donde el aprovechamiento del espacio es esencial. De serie se suministran predisuestas para gas propano – butano y se proporcionan inyectores para cambios a gas natural.

Gas outlet by the back part for easy installation in places where space utilization is essential. Series are supplied prearranged for propane - butane and injectors are provided for changes to natural gas.

Cocinas a Gas con Plancha Gas Stoves with Steel Plate

**Cocinas a Gas Sobremostrador con Plancha Acero Laminado 6 mm.
Gas Stoves Countertop with Steel Plate 6 mm.**



Fabricado en España con materiales de alta calidad. Certificado CE.
Made in Spain with high quality materials. CE certified.

Construido en acero inoxidable acabado satinado de espesor 0,8 mm.
Built in satin finish stainless steel 0.8 mm thick.

120CGPL



Plancha Izquierda



Plancha Central

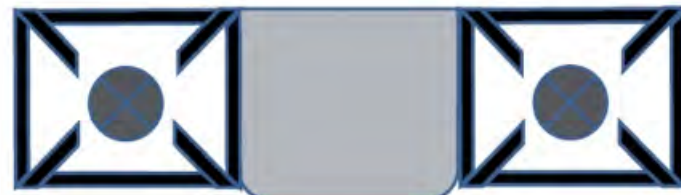

Plancha Derecha



Características Técnicas
Technical Features

Modelo Model	Válvulas Valves	Quemadores Burners	Potencia (Kw) Power (Kw)	Superficie útil (AxF) mm. Usable area (LxW) mm.	Dimensiones (AxFxH) mm. Dimensions (LxWxH) mm.	Peso (Kg) Weight (Kg)	PVP (EUR)
120CGPL	3	3	3,2 + 6 + 6	400x400 + 800x400	1210x457x240	42	960
40PL	Placa de acero laminado de 6 mm. con peto 36 mm.						50
40GR	Bandeja Recoge grasas						29



Fogón con termopar de gran poder calorífico de 6 Kw. Parrilla de acero pavonado de gran dureza totalmente desmontable para limpieza.
High calorific 6Kw stove with thermocouple. Blued steel grill very hard and completely removable for cleaning.



Posibilidad de convertir cualquier fogón en plancha con una placa de acero laminado de 6 m. con peto sobre el fogón.
Ability to convert a kitchen stove in a gas plate placing steel plate 6 mm. overall on the stove. Simply turning the grill plate fits 40x40 cm.



Mandos de baquelita de gran calidad con marcador de máximo/mínimo.
High quality bakelite controls with maximum/minimum marks.



Grasera opcional de acero inoxidable de gran capacidad para colocarse en parte trasera o frontal.
Optional stainless steel large capacity fat collector that can be used placed in back or front.

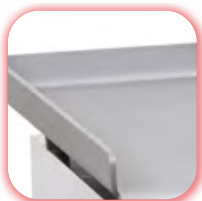

Placa de asar de 6 mm de espesor. Peto de 36 mm de altura. Fabricada en acero laminado con protección antioxidación.
Grill plate 6mm thick. Breastplate 36 mm high. Sheet steel made with anti-oxidation protection.



Grasera frontal de gran capacidad y fácilmente extraíble fabricada totalmente en acero inoxidable.
Front large capacity fat collector and easily removable, completely made of stainless steel.



Encendido automático por piezoeléctrico (1 por válvula de gas).
Auto power piezoelectric (1 gas valve).



Pies altos regulables de gran robustez.
Robust adjustable feet.



Quemador diseño ARILEX con salida de llama por todo su perímetro asegurando un reparto uniforme de calor por toda la placa. Sin "zonas frías". Gran poder calorífico con termopar de seguridad.
ARILEX design burner output with flame around its perimeter ensuring a uniform distribution of heat throughout the plate. Without "cold zones". High heating power with safety thermocouple.



Toma de gas por la parte trasera que facilita la instalación en sitios donde el aprovechamiento del espacio es esencial. De serie se suministran predisuestas para gas propano – butano y se proporcionan inyectores para cambios a gas natural.
Gas outlet by the back part for easy installation in places where space utilization is essential. Series are supplied prearranged for propane - butane and injectors are provided for changes to natural gas.

Cocinas gas sobremesa 400

Elemento básico en cualquier establecimiento.
Gran calidad, fiabilidad y robustez



Modelo Fogón

	Quemador	Fogón	Ancho/profundo/alto	Potencia	Peso	
30	COCI89	0	300x400x200 mm	3,6 Kw	10 Kg	438 €
60	COCI90	2	600x400x200 mm	7,2 Kw	19 Kg	714 €
90	COCI91	3	900x400x200 mm	10,8 Kw	28 Kg	1.038 €



COCI89



COCI90



COCI91



Construcción en acero inoxidable



Mandos de regulación en baquelita de alta calidad con indicador de máximo y mínimo.



Quemadores en acero inoxidable de gran poder calorífico y con dispositivo de seguridad individual.



Peto anti-salpicaduras en acero inox. (Gama Plus y Cromo)



SY.1 9,98 €

Rácor codo 90°
1/2 a 1/2 GAS

SY.2 6,14 €

Portagoma 1/2
Butano

(Chiclés butano instalados. Otros en dotación)

Quemador industrial (para uso en exteriores)



AC.185 87,32 €

Quemador industrial
Cap. 8,5 K
Gas: butano/propano



AC.184 160,52 €

Parrilla para quemador
Por un lado ranurado y por el otro liso
41 x 41 cm

Cocinas modulares a gas 600



COCI.6 956 €

2 Quemadores
Potencia: 9 kW (2x4.5 kW)
ancho/profundo/alto (cm): 33x60x29
Peso: 16 Kg



COCI.10 772 €

1 Quemador
Potencia: 8 kW (1x8 kW)
ancho/profundo/alto (cm): 33x60x29
Peso: 16 Kg



COCI.7 1.706 €

4 Quemadores
Potencia: 18 kW (4x4.5 kW)
ancho/profundo/alto (cm): 66x60x29
Peso: 21 Kg



COCI.11 1.342 €

2 Quemadores
Potencia: 16 kW (2x8 kW)
ancho/profundo/alto (cm): 66x60x29
Peso: 21 Kg



COCI.8 2.542 €

6 Quemadores
Potencia: 27 kW (6x4.5 kW)
ancho/profundo/alto (cm): 99x60x29
Peso: 33 Kg



COCI.12 1.934 €

3 Quemadores
Potencia: 24 kW (3x8 kW)
ancho/profundo/alto (cm): 99x60x29
Peso: 33 Kg



COCI.13 130 €

Accesorio Wok
Adaptador sartén



Quemador
Quemador profesional, desarmable para la fácil limpieza y cambio de las toberas. Rendimiento 4,5 ó 8 kW, parrilla separable, bandeja con nervios diseñados para una fácil limpieza.



Parrilla
Parrilla robusta, facilita la sujeción estable de los recipientes de calentado.



Botón de regulación.
Manipulación precisa y con mayor facilidad, mejor resistencia térmica.

(Chiclés gas instalados. Butano y otros en dotación)



Cocinas modulares a gas 600



COCI.27 710 €

2 Quemadores
1x3 kW + 1x3,6 kW
Potencia: 6,6 kW
Medidas ancho/profundo/alto (cm): 33x60x29
Peso: 16 Kg



COCI.28 1.190 €

4 Quemadores
2x3 kW + 2x3,6 kW
Potencia: 13,2 kW
Medidas ancho/profundo/alto (cm): 66x60x29
Peso: 21 Kg



COCI.29 1.700 €

6 Quemadores
3x3 kW + 3x3,6 kW
Potencia: 19,8 kW
Medidas ancho/profundo/alto (cm): 99x60x29
Peso: 33 Kg

Cocinas a gas con horno eléctrico



COCI.43 2.384 €

4 Quemadores
Horno convección. Rejilla horno GN 1/1 incluida
Potencia: 13,2 kW (2x3,6 kW + 2x3 kW)
Voltaje: 3,13 kW - 230 V/50 Hz
Medidas ancho/profundo/alto (cm): 66x60x86-92
Peso: 86 Kg



COCI.44 3.164 €

6 Quemadores
Horno convección. Rejilla horno GN 1/1 incluida
Potencia: 19,8 kW (3x3,6 kW + 3x3 kW)
Voltaje: 3,13 kW - 230 V/50 Hz
Medidas ancho/profundo/alto (cm): 99x60x86-92
Peso: 97 Kg



Parrilla
Parrilla robusta, facilita la sujeción estable de los recipientes de calentado.



Quemador
Desarmable para la fácil limpieza y cambio de las toberas.
Rendimiento 3,0 y 3,6 kW.



Botón de regulación.
Manipulación precisa y con mayor facilidad, mejor resistencia térmica. Diseño innovado, uniforma todos los modelos.



Horno inoxidable de aire caliente. Capacidad 4xGN1/1-65

Cocinas modulares eléctricas 600



COCI.1 472 €

2 Placas
Potencia: 3 kW (2x1,5 kW cada placa)
6 niveles de control
Voltaje: 230 V/3N/50 Hz - Monofásica
Medidas (cm): 33x60x29 (ancho/profundo/alto)
Peso: 12 Kg



COCI.2 530 €

2 Placas
Potencia: 4 kW (2x2 kW cada placa)
6 niveles de control
Voltaje: 400 V/3N/50 Hz - Trifásica
Medidas (cm): 33x60x29 (ancho/profundo/alto)
Peso: 12 Kg



COCI.3 898 €

4 Placas
Potencia: 8 kW (4x2 kW cada placa)
6 niveles de control
Voltaje: 400 V/3N/50 Hz
Medidas (cm): 66x60x29 (ancho/profundo/alto)
Peso: 24 Kg

COCI.4 1.280 €

6 Placas
Potencia: 12 kW (6x2 kW cada placa)
6 niveles de control
Voltaje: 400 V/3N/50 Hz
Medidas (cm): 99x60x29 (ancho/profundo/alto)
Peso: 33 Kg



Placas eléctricas
Diámetro 180 mm
Rendimiento 1,5 kW, 2 kW
Protección térmica.



Botón de regulación.
Manipulación fácil.
Alta resistencia térmica.



COCINAS SERIE SNACK 650 - MAKEXPRES



COCINA SOBREMESA SNACK

MODELO	A GAS	MEDIDAS	POTENCIA	EUROS
MK-4-TG	"	600x650x475	3,5 Kw x 2+4,5 Kw x 2	995



MK-4-TG

COCINA TRES FUEGOS CON HORNO - MAKEXPRES



MODELO	A GAS	MEDIDAS	POTENCIA QUEMADORES	POTENCIA HORNO	EUROS
MK-3-H	"	1.050 x 700 x 850/910	3,5 x 2 + 4,5	4,8 Kw	2.180
MEDIDAS HORNO: 570 x 670 x 300					



COCINA MK-3-H - 3 FUEGOS
Horno y armario lateral

BARBACOAS A GAS - PIEDRA LAVICA - Y FRY-TOP A GAS



BARBACOA - BK-40-TG

BARBACOA SERIE SNACK

MODELO	A GAS	MEDIDAS	POTENCIA	EUROS
BK-40-TG	"	400x650x475	6,9 Kw	695
CARGA DE LAVA SACO 11 KG.				115

FRY-TOP

MODELO	A GAS	MEDIDAS	POTENCIA	EUROS
FT-40-TG	"	400x650x475	6 Kw	790
FT-60-TG	"	600x650x475	6+6 Kw	995



FRY-TOP - FT-60-TG



HORNILLOS DE COCCIÓN GRAN RENDIMIENTO PAELLEROS INDUSTRIALES CON TERMOPAR DE SOBREMESA



Modelo	CORONAS	EUROS
H-440	2	460
H-660	3	995



CARACTERÍSTICAS H-440

Dimensiones 42 cm.
Plazas de 45 a 35
Embalaje 1
Pot. Nominal: 15 Kw = 13000 Kcal/h.
Preparado para Gas Natural-Propano.
Homologado CE. Modelo patentado.
Con válvula de seguridad y Termopar.

CARACTERÍSTICAS H-440

Dimensiones 62 cm.
Plazas de 4 a 90
Embalaje 1
Pot. Nominal: 25 Kw = 27000 Kcal/h.
Preparado para Gas Natural-Propano.
Homologado CE. Modelo patentado.
Con válvula de seguridad y Termopar.

PAELLEROS PROFESIONALES DE ALTA POTENCIA DE SOBREMESA



HP-40

MODELO	EUROS
HP-40	498
HP-310	998



HP-310

MODELO HP-40

Potencia	10,0
Dimensiones (mm)	623 355 h-230
Diámetro corona (mm)	250
Peso (Kg)	20

MODELO HP-310

Potencia	27,2
Dimensiones (mm)	790 480 h-230
Diámetro corona (mm)	Ext.: 450 Int.: 230
Peso (Kg)	40

CARACTERÍSTICAS GENERALES:

- Para uso interior y colectivo. Homologación CE.
- Gas: Natural o Butano/Propano (GLP).
- Válvulas de seguridad con termopar y piloto independiente.
- Fabricado en fundición de Grafito Laminar GG20.
- Acabado en pintura negra anticorrosiva.

HORNILLOS PAELLEROS A GAS DE GRAN RENDIMIENTO SOBRE BASTIDOR

MODELO	MEDIDAS	GAS CONSUMO	POTENCIA W	PESO	ALIMENTACIÓN	FUEGOS	EUROS
SPS706-G	600x700x450	1,87 m³/h	18000	80 Kg.		2	860
SPS706-GTR	740x820x500	2,38 m³/h	22960	95 Kg.		3	1.250



SPS706-G

HORNILLOS GRAN RENDIMIENTO

Armazón fabricado en acero inoxidable.
Preparados para gas butano o gas natural.
Con quemadores, válvula de seguridad y termopar.
Si la llama se descontrola, el gas se corta.



SPS706-GTR

PAELLEROS PROFESIONALES ALTA POTENCIA MONTADOS SOBRE MUEBLE



MB-2-HP-310



MB-1-HP-40

MODELOS MUEBLE BAJO

MODELO MB-2 - HP310

Quemador	HP-310
Potencia (Kw)	27,2
Dimensiones (mm)	800 900 h-550
Peso (Kg)	60

MODELO	MUEBLE	EUROS
MB-1-HP-40	BAJO	1.295
MB-2-HP-310	BAJO	1.856

CARACTERÍSTICAS:

- Para uso interior y colectivo. Homologación CE.
- Gas: Natural o Butano/Propano (GLP).
- Estructura de Acero Inoxidable

MODELO MB-1 - HP40

Quemador	HP-40
Potencia (Kw)	10,0
Dimensiones (mm)	700 700 h-550
Peso (Kg)	40



MAE-2-HP-310

MODELOS MUEBLE ALTO

ALTO: H. 850 + 10%
CON PARRILLA SUPERIOR EXTRAÍBLE

COCINAS SOBREMOSTRADOR CON PLANCHA PARA ASAR "OPCIONAL"

MODELO	LARGO x FONDO x ALTO	FUEGOS	KW.	EUROS
CG-40-P	410 x 457 x 260	1	6	425
CG-80-P	810 x 457 x 260	2	6+6	740
PL-40 PLANCHA LISA	40 x 40			98
GR-40 GRASERA PARA PLANCHA	40 x 40			38



- Mueble de acero inoxidable con aristas redondeadas, para facilitar su limpieza.
- **FOGONES EXTRAÍBLES** para facilitar su limpieza y mantenimiento.
- **Fogones de gran poder calorífico 6 kW-Gas. Con parrilla de acero pavonado de gran dureza y totalmente desmontable para su limpieza.**
- **Quemadores de gran poder calorífico con termopar de seguridad.**
- Mandos de bakelita de gran calidad con marcador de máximo/mínimo.
- Panel frontal extraíble para facilitar las labores de mantenimiento.
- **Pies regulables en altura.**
- Preparada para toma izquierda o derecha.
- Preparada a gas butano, incluye inyectores para gas natural.
- **Con piezoeléctrico** para facilitar el encendido.



POSIBILIDAD DE COLOCAR UNA PLANCHA ADICIONAL SOBRE EL FOGÓN
GIRANDO LA PARRILLA ENCAJA UNA PLANCHA DE 40 x 40 cm. "OPCIONAL".

NUEVAS COCINAS



COCINAS SOBREMESA GAMA - 600 - DELTA

MODELO	LARGO x FONDO x ALTURA	FUEGOS	POTENCIA	ALIMENTACIÓN	EUROS
COS-2-60	800 x 600 x 260	2	12 Kw	GN/GLP	998
COS-3-60	1200 x 600 x 260	3	15,5 Kw	GN/GLP	1.260



COS-2-60



COS-3-60

CARACTERÍSTICAS CONSTRUCTIVAS:

Construcción íntegra en acero inoxidable con acabado AISI-304. Encimera estampada. Parrilla de fundición. Control de fuegos mediante válvula con termopar de seguridad. Encendido eléctrico con alimentación a 220 V. Quemadores con cabeza desmontable para limpieza.

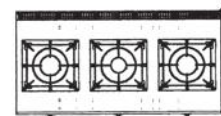

MODELO	COS-2-60	COS-3-60
QUEMADORES	2 x 6 Kw.	2 x 6 Kw. + 1 x 3,5 Kw.
POTENCIA	12 Kw.	15,5 Kw.

COCINAS SOBREMESA GAMA - 700 - DELTA

MODELO	LARGO x FONDO x ALTURA	FUEGOS	POTENCIA	ALIMENTACIÓN	EUROS
COS-4-70	800 x 700 x 260	4	19 Kw	GN/GLP	1.325
COS-6-70	1200 x 700 x 260	6	28,5 Kw	GN/GLP	1.790



COS-6-70

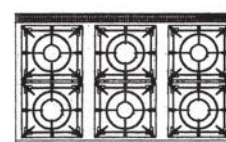
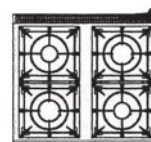

MODELO	COS-4-70	COS-6-70
QUEMADORES	2 x 6 Kw. + 2 x 3,5 Kw.	3 x 6 Kw. + 3 x 3,5 Kw.
POTENCIA	19 Kw.	28,5 Kw.

CARACTERÍSTICAS CONSTRUCTIVAS:

Construcción íntegra en acero inoxidable con acabado AISI-304. Encimera estampada. Parrilla de fundición. Control de fuegos mediante válvula con termopar de seguridad. Encendido eléctrico con alimentación a 220 V. Quemadores con cabeza desmontable para limpieza.

PLANCHAS PARA COCINAS GAMAS - 600 Y 700



PL-60

PL-70-D

MODELO	LARGO x FONDO	EUROS
PL-60	340 x 390	140
PL-70-D	340 x 620	210

CARACTERÍSTICAS CONSTRUCTIVAS:

Construcción mediante placa de hierro de 1 cm. de grosor. Ranurado perimétrico para evitar el derrame de grasas.

COCINAS SOBREMUEBLE ABIERTO - GAMA - 600 - DELTA

MODELO	LARGO x FONDO x ALTURA	FUEGOS	POTENCIA	ALIMENTACIÓN	EUROS
COS-2-M-60	800 x 600 x 850	2	12 Kw	GN/GLP	1.190
COS-3-M-60	1200 x 600 x 850	3	15,5 Kw	GN/GLP	1.480

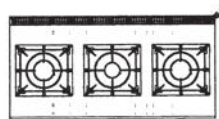
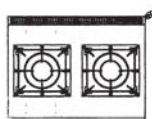

MODELO	COS-2-M-60	COS-3-M-60
QUEMADORES	2 x 6 Kw.	2 x 6 Kw. + 1 x 3,5 Kw.
POTENCIA	12 Kw.	15,5 Kw.



COS-3-M-60

COCINAS SOBREMUEBLE ABIERTO - GAMA - 700 - DELTA

MODELO	LARGO x FONDO x ALTURA	FUEGOS	POTENCIA	ALIMENTACIÓN	EUROS
COS-4-M-70	800 x 700 x 850	4	19 Kw	GN/GLP	1.575
COS-6-M-70	1200 x 700 x 850	6	28,5 Kw	GN/GLP	1.998

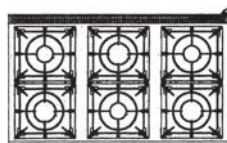
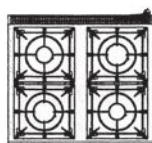

MODELO	COS-4-M-70	COS-6-M-70
QUEMADORES	2 x 6 Kw.+ 2 x 3,5 Kw.	3 x 6 Kw. + 3 x 3,5 Kw.
POTENCIA	19 Kw.	28,5 Kw.



COS-4-M-70



COS-6-M-70

CARACTERÍSTICAS COMUNES:

- Encimera embutida en acero inoxidable AISI 304 de 1,2 mm. de espesor.
- Quemadores de fundición de latón.
- Suministro de gas mediante válvulas con termopar de seguridad.
- Rejillas superiores en hierro fundido con tratamiento anticorrosión.
- Patas regulables en altura.



COCINAS SOBREMUEBLE ARMARIO CERRADO - GAMA - 600 - DELTA

MODELO	LARGO x FONDO x ALTURA	FUEGOS	POTENCIA	ALIMENTACIÓN	EUROS
COS-2-MC-60	800 x 600 x 850	2	12 Kw	GN/GLP	1.460

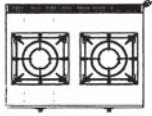

MODELO COS-2-MC-60

QUEMADORES	2 x 6 Kw.
POTENCIA	12 Kw.

CARACTERÍSTICAS:

- Encimera embutida en acero inoxidable AISI 304 de 1,2 mm. de espesor.
- Quemadores de fundición de latón.
- Suministro de gas mediante válvulas con termopar de seguridad.
- Rejillas superiores en hierro fundido con tratamiento anticorrosión.
- Patas regulables en altura.



COS-2-MC-60

COCINAS SOBREMUEBLE ARMARIO CERRADO - GAMA - 700 - DELTA

MODELO	LARGO x FONDO x ALTURA	FUEGOS	POTENCIA	ALIMENTACIÓN	EUROS
COS-4-MC-70	800 x 700 x 850	4	19 Kw	GN/GLP	1.850

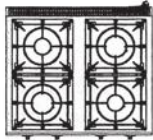

MODELO COS-4-MC-70

QUEMADORES	2 x 6 Kw. + 2 x 3,5 Kw.
POTENCIA	19 Kw.

CARACTERÍSTICAS:

- Encimera embutida en acero inoxidable AISI 304 de 1,2 mm. de espesor.
- Quemadores de fundición de latón.
- Suministro de gas mediante válvulas con termopar de seguridad.
- Rejillas superiores en hierro fundido con tratamiento anticorrosión.
- Patas regulables en altura.



COS-4-MC-70

COCINAS CON HORNO - GAMA - 600 - DELTA

MODELO	LARGO x FONDO x ALTURA	FUEGOS	EUROS
CCH-2-60	800 x 600 x 850	2	1.790
CCH-3-60	1200 x 600 x 850	3	2.150

MODELO	DIMENSIONES HORNO	POTENCIA	ALIMENTACIÓN
CCH-2-60	660 x 430 x 350	19 Kw.	GN/GLP
CCH-3-60	660 x 430 x 350	22,5 Kw.	GN/GLP

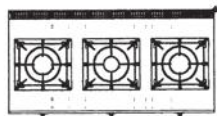
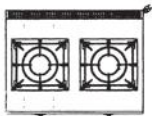

MODELO	CCH-2-60	CCH-3-60
QUEMADORES	2 x 6 Kw.	2 x 6 Kw. + 1 x 3,5 Kw.
POTENCIA	19 Kw.	22,5 Kw.
HORNO	7 Kw.	7 Kw.

CARACTERÍSTICAS:

Encimera embutida en acero inoxidable AISI 304. Quemadores de fundición de latón. Suministro de gas mediante válvulas con termopar de seguridad. Rejillas superiores en hierro fundido con tratamiento anticorrosión. Horno dotado de parrilla cromada. Soportes para parrilla con tres niveles de regulación. Calentamiento del horno mediante quemador con llama estabilizada y encendido mediante pulsante. Válvula del horno con termopar de seguridad. Temperatura de horno regulable controlada mediante válvula termostática. Patas de acero inoxidable regulables en altura.



CCH-3-60

NUEVAS COCINAS



COCINAS CON HORNO GAMA - 700 - DELTA

MODELO	LARGO x FONDO x ALTURA	FUEGOS	DIMENSIONES HORNO	POTENCIA	ALIMENTACIÓN	EUROS
CCH-4-70	800 x 700 x 850	4	660 x 530 x 350	19 Kw	GN/GLP	2.150
CCH-6-70	1200 x 700 x 850	6	660 x 530 x 350	28,5 Kw	GN/GLP	2.680



CCH-4-70

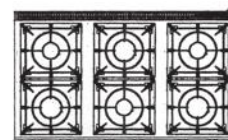

MODELO	CCH-4-70	CCH-6-70
QUEMADORES	2 x 6 Kw. + 2 x 3,5 Kw.	3 x 6 Kw. + 3 x 3,5 Kw.
POTENCIA	26 Kw.	35,5 Kw.
HORNO	7 Kw. (GN 2/1)	7 Kw. (GN 2/1)



CCH-6-70

CARACTERÍSTICAS CONSTRUCTIVAS:

Construcción íntegra en acero inoxidable con acabado AISI 304. Encimera estampada. Parrilla de fundición. Horno inferior construido totalmente en chapa de acero inoxidable. Incorpora rejilla en hierro cromado. Control de fuegos mediante válvula con termopar de seguridad. Encendido eléctrico con alimentación a 220 V. Quemadores con cabeza desmontable para limpieza. Construcción con horno o sobre vano inferior abierto. Las dimensiones del horno permiten la colocación de bandejas gastronorm GN 2/1 directamente sobre las guías. Parrilla del horno incluida.



COMPOSICIONES GAMAS 600 Y 700 - SOBRE MUEBLE - TECMAX



COCINAS



COCINAS



FRYTOPS



BAÑOS MARÍA



FREIDORAS

COCINAS - SERIE 600

TECMAX



Esta gama de elementos modulares permite diseñar unas cocinas a la medida de cada cliente, según su necesidad. Dentro de la gama 600 encontrará todos los módulos necesarios para formar una completa cocina. En la página 127 están las mesas soporte, y en las páginas 128, 129 y 130 todos los elementos modulares restantes para las composiciones.

MESAS SOPORTE PARA SERIE - 600



MODELO	EUROS
D-604-D	298

- Mueble en acero inoxidable.
- Patas regulables.
- Medidas: 400 x 520 x 660.
- Peso: 14 kg.
- Volumen: 0,15 m³



MODELO	EUROS
D-604-C	495

- Mueble en acero inoxidable.
- Patas regulables.
- Medidas: 400 x 520 x 660.
- 3 Cajones GN 1/1
- Peso: 19 kg.
- Volumen: 0,15 m³



MODELO	EUROS
D-606-D	390

- Mueble en acero inoxidable.
- Patas regulables.
- Medidas: 600 x 520 x 660.
- Peso: 24 kg.
- Volumen: 0,22 m³



COCINAS SOBREMESA A GAS - SERIE 600

MODELO	LARGO x FONDO x ALTO	FUEGOS	POTENCIA W	PESO	ALIMENTACIÓN	EUROS
GC-604	400 x 600 x 265	2	2 X 3600	15 Kg.	GAS	495
GC-606	600 x 600 x 265	4	4 X 3600	25 Kg.	GAS	790



GC-604



GC-606

CARACTERÍSTICAS:

- Fabricadas en acero inoxidable. - Equipadas con válvula de seguridad termopar preparadas para GN - Gas natural o GLP - Propano.
- Incluye los inyectores para los dos tipos de gas.

COCINAS SOBREMESA ELÉCTRICAS - SERIE 600

MODELO	LARGO x FONDO x ALTO	FUEGOS	POTENCIA W	PESO	ALIMENTACIÓN	EUROS
EC-604	400 x 600 x 265	2	2 x 2000	15 Kg.	220V-50 Hz	490
EC-606	600 x 600 x 265	4	3 x 2000 + 1000	22 Kg.	380V-50 Hz	870



EC-604



EC-606

CARACTERÍSTICAS:

- Fabricadas en acero inoxidable. - Selector de intensidad de 0 - 7. - Diámetro Ø: 180 mm.

FRYTOP SOBREMESA A GAS - SERIE 600

MODELO	LARGO x FONDO x ALTO	PLANCHA	POTENCIA W	PESO	ALIMENTACIÓN	EUROS
GG-604	400 x 600 x 265	LISA	4800	37 Kg.	GAS	830
GG-606	600 x 600 x 265	LISA	2 x 4800	55 Kg.	GAS	1.170
GG-606- SG	600 x 600 x 265	1/2 LISA 1/2 RANURADA	2 x 4800	55 Kg.	GAS	1.225



GG-604 LISA



GG-606 LISA
GG-606 SG
1/2 LISA
1/2 RANURADA

CARACTERÍSTICAS:

- Fabricadas en acero inoxidable.
- Superficie cocción plancha acero de 15 mm. acabado espejo.
- Quemadores independientes en acero inoxidable.
- Encendido automático con válvula de seguridad termopar.
- Preparadas para gas natural con inyectores para gas butano.
- Cajón recoge grasas frontal.

COCINAS SOBREMESA- A GAS - SERIE 700



MODELO	LARGO x FONDO x ALTO	FUEGOS	POTENCIA W	PESO	ALIMENTACIÓN	EUROS
GR-711-S	400 x 700 x 290	2x4350	2x3600	32 Kg.	GAS	840
GR-721-S	800 x 700 x 290	4x4350	4x3600	47 Kg.	GAS	1.350
GR-731-S	1200 x 700 x 290	6x4350	6x3600	68 Kg.	GAS	1.890



GR- 711-S
GAS CONSUMO: GN - NATURAL: 1,25 m³/h.
 LPG-PROPANO: 0,94 Kg./h.



GR- 721-S
GAS CONSUMO: GN - NATURAL: 2,50 m³/h.
 LPG-PROPANO: 1,88 Kg./h.



GR- 731-S
GAS CONSUMO: GN - NATURAL: 3,75 m³/h.
 LPG-PROPANO: 2,82 Kg./h.

CARACTERÍSTICAS:

- Fabricadas en acero inoxidable.
- Quemadores con piloto. Válvula de seguridad con termopar, preparadas para GN- Gas natural o GLP Propano.
- Incluye los inyectores para los dos tipos de gas.

COCINAS SOBREMESA- ELÉCTRICAS - LÍNEA 700



MODELO	LARGO x FONDO x ALTO	FUEGOS	POTENCIA W	PESO	ALIMENTACIÓN	EUROS
ER-711-S	400 x 700 x 290	2	2x2600	32 Kg.	220 V - 50 HZ	640
ER-721-S	800 x 700 x 290	4	4x2600	40 Kg.	380 V - 50 HZ	960
ER-731-S	1200 x 700 x 290	6	6x2600	60 Kg.	380 V - 50 HZ	1.280



ER- 711-S



ER- 721-S



ER- 731-S

CARACTERÍSTICAS:

- Fabricadas en acero inoxidable.
- Control por termostato.
- Selector de intensidad de 0-7.
- Diámetro Ø 220 mm.



COCINAS A GAS - SERIE 700 CON HORNO

MODELO	LARGO x FONDO x ALTO	FUEGOS	POTENCIA W	PESO	ALIMENTACIÓN	EUROS
GR-722	800 x 700 x 900	4	4x3.600+3.000	110 Kg.	GAS	2.350
GR-722-E	800 x 700 x 900	4	4x3.600+3.000	110 Kg.	GAS	2.350
GR-732	1.200 x 700 x 900	6	6x3.600+3.000	140 Kg.	GAS	3.250
GR-732-E	1.200 x 700 x 900	6	6x3.600+3.000	140 Kg.	GAS	3.250



GR-722-E
4 FUEGOS HORNO ELÉCTRICO



GR-722
4 FUEGOS HORNO A GAS

CARACTERÍSTICAS:

- Construidas totalmente en acero inoxidable. Quemadores con piloto. Válvula de seguridad y termopar. El modelo GR-722 con horno a gas de encendido piezo eléctrico. El modelo GR-722-E, horno eléctrico con electroventilador. Ambos hornos para bandejas GN 1/1 ó 600 x 400 mm. con 1 parrilla GN- 1/1 en dotación. Capacidad bandejas 4.



GR-732
6 FUEGOS HORNO A GAS



GR-732-E
6 FUEGOS HORNO ELÉCTRICO



HORNO A GAS GN - 1/1

CARACTERÍSTICAS:

- Cocinas preparadas para Gas Natural con dotación de inyectores para propano butano.



HORNO ELÉCTRICO GN - 1/1



COCINAS CHINAS - WOK

CARACTERÍSTICAS GENERALES:

Construidas totalmente en acero inox AISI 304.

ENCIMERA HERMÉTICA DE 3 mm. DE ESPESOR.

Parrilla-soporte cuenco y aro protector quemadores de fundición esmaltada en porcelana negra vitrificada y extraíbles.

Diámetro de soporte cuenco: 30 cms.

Quemadores atmosféricos de fundición, equipados con válvula de seguridad y piloto de encendido.

Quemador aire forzado de fundición, equipado con válvula de seguridad, piloto de encendido y ventilador accionado mediante interruptor -voltaje ventilador: 230 V /50 Hz.-.

Gran versatilidad en la potencia de los quemadores atmosféricos, variando desde 14 Kw hasta 21 Kw.

Potencia quemador turbo: 21 Kw y HOMOLOGADO SIN CENTRALITA ELECTRÓNICA.

LAVADO AUTOMÁTICO integrado por una hilera de chorros de agua y un canal de recuperación/desagüe provisto de un filtro en acero inox.

GRIFOS giratorios para el llenado de ollas, accionamiento frontal mediante interruptor de doble accionamiento (pulsante o continuo).

SOPORTE INFERIOR armazonado, con laterales y trasera cerrado en acero inox. Estante inferior. Patas regulables.

OPCIONALES: Posibilidad de colocar horno, zonas neutras de apoyo, alojamiento para cubetas, fry-top, etc.



CH-2-L-35

MODELO	MEDIDAS	PETO MURAL	FUEGOS	QUEMADOR ATMOS. 14 KW	QUEMADOR ATMOS. 21 KW	QUEMADOR TURBO 21 KW.	EUROS
CH-1-L-21	600x700x850	25 cm.	 1 FUEGO-L		1		2.100
CH-2-L-35	1000x700x850	25 cm.	 2 FUEGOS-L		1	1	2.960
CH-3-L-43	1500x700x850	25 cm.	 3 FUEGOS-L	1	1	1	3.690

MODELO	CONSUMO / CONSUMPTION G.N. G.I.P.	PESO (WEIGHT)
CH-1-L-21	1,82 m³/h. - 1,54 Kg./h.	57 Kg.
CH-2-L-35	3,79 m³/h. - 3,11 Kg./h.	105 Kg.
CH-3-L-43	4,96 m³/h. - 4,08 Kg./h.	130 Kg.

**OTROS MODELOS MAYORES
CONSULTAR PRECIOS Y
CARACTERÍSTICAS**

COCINAS SERIE 900 CON HORNO

MODELO	MEDIDAS	FUEGOS	PESO	POTENCIA W	ALIMENTACIÓN	EUROS
GR-922	850 x 900 x 900	4	158	4x8.000+7.500	GAS	2.850
GR-922-E	850 x 900 x 900	4	158	4x8.000+6.000	GAS/ELEC. 380 V3-, 50 Hz	2.995



GR-922-E
HORNO ELÉCTRICO

GAS CONSUMO

NG - NATURAL 3,34 m³/h.
LPG-PROPANO 2,51 Kg./h.



GR-922
HORNO A GAS

GAS CONSUMO

NG - NATURAL 4,12 m³/h.
LPG-PROPANO 3,10 Kg./h.

CARACTERÍSTICAS:

- Construidas totalmente en acero inoxidable. Quemadores con piloto. Válvula de seguridad y termopar. Los modelos GR-922 con horno a gas de encendido piezo eléctrico y el modelo GR-922-E horno eléctrico con electroventilador. Ambos hornos para una parrilla. GN-2/1 en dotación. Capacidad bandejas 4.

MODELO	MEDIDAS	FUEGOS	PESO	POTENCIA W	ALIMENTACIÓN	EUROS
GR-932	1.275 x 900 x 900	6	203	6x8.000+7.500	GAS	3.995
GR-932-M	1.275 x 900 x 900	6	203	6x8.000+7.500	GAS	4.650



GR-932
HORNO A GAS

GAS CONSUMO

NG - NATURAL 5,79 m³/h.
LPG-PROPANO 4,35 Kg./h.



GR-932-M
HORNO MAXI A GAS

CARACTERÍSTICAS:

- Construidas totalmente en acero inoxidable. Quemadores con piloto. Válvula de seguridad y termopar. El modelo 932 con horno a gas de encendido piezo eléctrico para bandejas o parrillas GN-2/1. - El modelo 932-M Maxi horno a gas de medidas especiales de cámara 97 x 30,5 x 66 cm. Parrillas de 93 x 65 cm.



FREIDORAS ELÉCTRICAS - SERIE 900 - SOBRE MUEBLE



MODELO	LARGO x FONDO x ALTO	CUBAS	LITROS	POTENCIA	PESO	ALIMENTACIÓN	EUROS
EF - 912	425 x 900 x 900	1	1x18	14.000W	62 Kg.	380 V3-, 50 Hz	2.295
EF - 922	850 x 900 x 900	2	2x18	2 x 14.000	100 Kg.	380 V3-, 50 Hz	3.680
CESTA BSK 19	145 x 375 x 150 mm.						64

CARACTERÍSTICAS:

- Construidas totalmente en acero inoxidable.
- Freidoras de gran potencia.
- Ultrápidas con bordes redondeados para facilitar la limpieza.
- Cestas incorporadas.
- Sistema de suspensión de la cesta para escurrir el aceite sobrante.
- Provistas de termostato de trabajo y termostato de seguridad.
- Montadas sobre mueble en acero inox con patas regulables.



EF-912



EF-922

CESTA

MODELO	LARGO x FONDO x ALTO mm.
BSK19	145 x 375 x 150



Cocinas 600



L6CE30



L6CG60



L6CG90



L6CG120HG

Características:

- Acero inoxidable
- Eléctricas o gas
- Grifos con dispositivo de seguridad (gas)
- Horno de gas con gratinador (opcional)
- Pies ajustables en altura

Cocinas 600

Referencia	Eléctrico/Gas	mm	m3	kg	kW	V	Hz	PVP	Obs.
L6CE30/0	Eléctrico	300x600x340	0,06	10	4	230/1N	50-60	508,00 €	
L6CE30/1	Eléctrico	300x600x340	0,06	10	4	400/3N	50-60	508,00 €	
L6CE60/0	Eléctrico	600x600x340	0,12	20	8	230/1N	50-60	752,00 €	
L6CE60/1	Eléctrico	600x600x340	0,12	20	8	400/3N	50-60	752,00 €	
L6CG60	Gas	600x600x340	0,12	31	9,6	-	-	873,00 €	
L6CG90	Gas	900x600x340	0,18	48	14,4	-	-	1.195,00 €	
L6CG120HG	Gas	1200x600x850	0,61		24,84	-	-	1.950,00 €	

Cocinas 700



L7CG40



L7CG80



L7CG80HG



L7CG120HG

Cocinas 700

Características:

- Acero inoxidable
- Grifos con dispositivo de seguridad (gas)
- Horno de gas (según modelo)
- Pies ajustables en altura

Referencia	Eléctrico/Gas	Mm	m3	kg	kW	V	Hz	PVP	Obs.
L7CG40	Gas	400x700x850	0,23		12	-	-	1.050,00 €	2 Fuegos, Base abierta
L7CG80	Gas	800x700x850	0,47		24	-	-	1.485,00 €	4 Fuegos, Base abierta
L7CG80HG	Gas	800x700x850	0,47		30	-	-	2.400,00 €	4 Fuegos, Horno Gas
L7CG120	Gas	1200x700x850	0,71		36	-	-	1.900,00 €	6 Fuegos, Base abierta
L7CG120HG	Gas	1200x700x850	0,71		42	-	-	3.100,00 €	6 Fuegos, Horno Gas



4,1 kW

SCG-40 E



4,1 kW
4,1 kW
4,1 kW

SCG-60 E

Cocinas a gas

- Modelos de 400 y 600 mm de ancho provistos de robustas parrillas esmaltadas, válvulas de seguridad, termopar y piezo-eléctrico.
- Cada elemento incorpora 2 o 4 quemadores de alta potencia de 4,1 kW, y encimera embudida para evitar el desbordamiento de líquidos en el sobre de acero inoxidable.
- Se suministran montados con inyectores para **gas natural**. Si la instalación no está preparada para este gas, en el interior del embalaje se incorporan inyectores para **gas butano/propano (GLP)**.
- Dimensiones de la parrilla: 400 x 275 mm.

Modelo	Referencia	Medidas (mm)	Nº Quemadores	Potencia kW (Kcal)	P.V.P. Euros €
SCG-40 E	3931101	400 x 650 x 440	2	8,14 (7000)	823,00
SCG-60 E	3931102	600 x 650 x 440	4	16,28 (14000)	1.212,00

Cocinas a gas con horno

- Dos modelos de 600 mm de ancho con horno en acero inoxidable.
- Cocina de 4 fuegos de alta potencia de 4,1 kW cada fuego. Provista de robustas parrillas esmaltadas, válvulas de seguridad, termopar y piezo-eléctrico.
- Se suministran montados con inyectores para **gas natural**. Si la instalación no está preparada para este gas, en el interior del embalaje se incorporan inyectores para **gas butano/propano (GLP)**.
- Dimensiones de la parrilla: 400 x 275 mm.
- **Características de los hornos:**
- Dimensiones del horno: 450 x 420 x 300 mm.
- **Horno a gas** en acero inoxidable con quemador tubular de 5.000 kcal/h, con piloto de encendido y termopar. Control de la temperatura por válvula termostática (130 - 350 °C).
- **Horno eléctrico** en acero inoxidable con resistencias en solera de 3 kW y en la parte superior de 3 kW. Conmutador de 3 posiciones. Termostato de 50 - 310 °C.



4,1 kW
4,1 kW
4,1 kW

SCGH-60 E

Modelo	Referencia	Medidas (mm)	Nº Quemadores	Potencia cocina kW (Kcal)	Potencia horno kW (Kcal)	Horno tipo	P.V.P. Euros €
SCGHG-60 E	3931103	600 x 650 x 1000	4	16,28 (14000)	5,8 (5000)	Gas	2.124,00
SCGHE-60 E	3931104	600 x 650 x 1000	4	16,28 (14000)	3+3 (5160)	Eléctrico	2.187,00



SCE-40 E

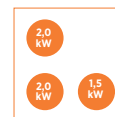

SCE-60 E

Cocinas eléctricas

- Modelos de 400 y 600 mm de ancho construidos en acero inoxidable provistos de placas de 1800 mm de diámetro, y encimera embutida para evitar el desbordamiento de líquidos en el sobre de acero inoxidable.
- Ambas placas incorporan control de seguridad contra el recalentamiento.

- La regulación de la temperatura se realiza mediante un conmutador de 6 posiciones con su correspondiente piloto de funcionamiento.

Modelo	Referencia	Medidas (mm)	Nº Placas	Potencia (kW)	Tensión (V)	P.V.P. Euros €
SCE-40 E	3911101	400 x 650 x 440	2	4,0	400/3N - 220/1N - 50/60 Hz	677,00
SCE-60 E	3911102	600 x 650 x 440	4	7,5	400/3N - 220/1N - 50/60 Hz	1.220,00



SCV-40 E

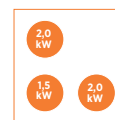

SCV-60 E

Cocinas vitrocerámicas

- Encimera de vitrocerámica con resistencias de potencia única o doble, controladas mediante un regulador de energía de 8 posiciones y con pilotos de calor residual.
- Calentamiento rápido y fácil limpieza.

Modelo de 400 mm con 2 zonas de cocción:

- 1 x 1,5 kW - Ø 180 mm.
- 1 x 2 kW - Ø 210 mm.
- Dimensiones de la encimera 320 x 540 mm.

Modelo de 600 mm con 4 zonas de cocción:

- 2 x 1,5 kW - Ø 180 mm.
- 2 x 2 kW Ø 210 mm.
- Dimensiones de la encimera 520 x 540 mm.

Modelo	Referencia	Medidas (mm)	Zonas cocción	Potencia (kW)	Tensión (V)	P.V.P. Euros €
SCV-40 E	3911103	400 x 650 x 440	2	3,5	220/1N - 50/60 Hz	1.390,00
SCV-60 E	3911104	600 x 650 x 440	4	7	400/3N - 220/1N - 50/60 Hz	1.984,00



ECG-40

4,0 kW

Cocina a gas

- Cocina a gas de 400 mm de ancho provista de robusta parrilla de hierro colado que permite el desplazamiento de un fuego al otro.
- Incorpora 2 quemadores monocorona, de hierro colado y elevada potencia: 1 de 3.440 Kcal/h (4 kW) y 1 de 6.708 Kcal/h (7,8 kW).
- Encendido con llama piloto y grifo de seguridad, con regulación progresiva de la potencia erogada.
- Se suministra montada con inyectores para gas natural. En el interior del embalaje se incluyen inyectores para gas butano / propano (GLP).



Quemador grifo de seguridad y encendido con llama piloto.

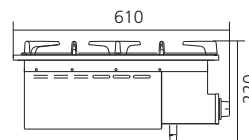
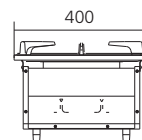

Modelo	Referencia	Nº quemadores	Medidas totales (mm)	Medidas encastre (mm)	Potencia kW (Kcal/h)	P.V.P. Euros €
ECG-40	4036101	2	400 x 610 x 220	360 x 585	11,8 (10148)	1.063,00



ECE-42

2,6 kW

2,6 kW

Cocina eléctrica

- Cocina eléctrica de 400 mm de ancho.
- Con 2 placas cuadradas de 220 x 220 mm.
- Potencia de las placas: 2,6 y 2,6 kW.
- Control de seguridad contra el recalentamiento de las placas.
- Regulación de la temperatura mediante conmutador de 7 posiciones con su correspondiente piloto de funcionamiento.

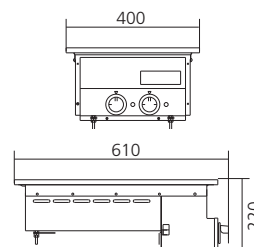

Modelo	Referencia	Número placas	Medidas totales (mm)	Medidas encastre (mm)	Potencia (kW)	Tensión (V)	P.V.P. Euros €
ECE-42	4016112	2	400 x 610 x 220	360 x 585	5,2	230-400/3-3N - 50/60 Hz	1.639,00



ECV-40

2,5 kW

2,5 kW

Cocina vitrocerámica

- Modelo de 400 mm de ancho.
- Encimera de vitrocerámica de 6 mm de espesor.
- Con 2 zonas de cocción con resistencias de doble potencia.
- Potencia: 2 x 2500-1000 W (ø 250-160 mm).
- Calentamiento rápido mediante resistencias de incandescencia.
- Fácil limpieza.

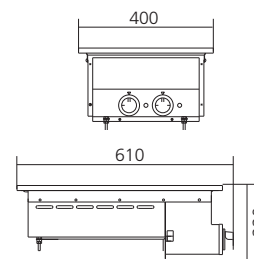

Modelo	Referencia	Zonas cocción	Medidas totales (mm)	Medidas encastre (mm)	Potencia (kW)	Tensión (V)	P.V.P. Euros €
ECV-40	4016101	2	400 x 610 x 220	360 x 585	5	230-400 / 3-3N - 50/60 Hz	1.645,00



EFE-40

Freidora eléctrica

- Freidora eléctrica de 1 cuba, de 400 mm de ancho.
- Cuba embutida y amplia zona fría, que evita que los residuos de la fritura entren en contacto con el aceite caliente, preservándolo más tiempo.
- Calentamiento mediante resistencias blindadas, elevables para facilitar la limpieza de la cuba.
- Control de la temperatura mediante termostatos de trabajo y de seguridad.
- Con rejilla de filtro, grifo de desagüe y llave de paso.



Capacidad de cuba 8 litros.



Resistencias elevables. Cubas embutidas y amplia zona fría.

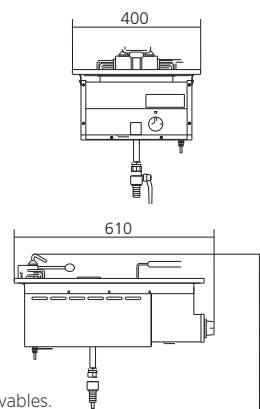

Modelo	Referencia	Capacidad (litros)	Medidas totales (mm)	Medidas encastre (mm)	Potencia (kW)	Tensión (V)	P.V.P. Euros €
EFE-40	4016103	8	400 x 610 x 475	360 x 585	75	230-400 / 3-3N - 50/60 Hz	1.788,00



▶ **C3F550H**



- Construcción en acero inoxidable.
Stainless steel construction.
Construction en acier inox.
- Fuegos superiores de gran rendimiento calorífico niquelado.
Burners of high heat performance nickel-plated.
Feux supérieurs à haut rendement calorifique nickelés
- Guías del horno de fácil extracción para la limpieza del mismo.
Removable base plates for an easy cleaning.
Guides du four de facile retrait pour nettoyage.
- Horno con encendido piezo eléctrico.
Oven with piezo ignition.
Four avec allumage piézoélectrique.
- Válvula termostática de serie en el horno.
Standard thermostatic valve in the oven..
Robinet thermostatique de série dans le four.
- Parrilla superior fundición.
Cast iron grill.
Grille en fonte.
- Todos los quemadores incorporan llama piloto.
All burners incorporate pilot flame.
Tous les brûleurs sont dotés d'une flamme pilote.
- Termopar de seguridad.
Safety thermocouple.
Sécurité par thermocouple.
- Horno gastronorm 1/1
1/1 Gastronorm oven
Four gastronorme 1/1.
- Nuevo tirador en acero inoxidable.
New stainless steel handle.
Nouvelle poignée en acier inoxydable.
- Parrilla horno antivuelco extraíble.
Removable roll grill oven.
Grill de rétention amovible.
- Altura mínima de chimenea para la utilización de cazuelas de gran diámetro.
Minimum height of chimney for the use of large diameter pots.
La hauteur minimale de la cheminée pour l'utilisation de cuves de grand diamètre.
- Patas de acero inoxidable regulables en altura.
Stainless steel legs with adjustable height.
Pieds inox réglables en hauteur.
- Burlete en fibra de vidrio, alta resistencia y gran eficiencia energética.
Gasket in fiberglass, high strength and high energy efficiency.
Joint en fibre de verre, haute résistance et à haute efficacité énergetique.

▶ Cambio de quemador de 4,5 Kw a 7,5 Kw
PVP 100 € por quemador (Bajo pedido).

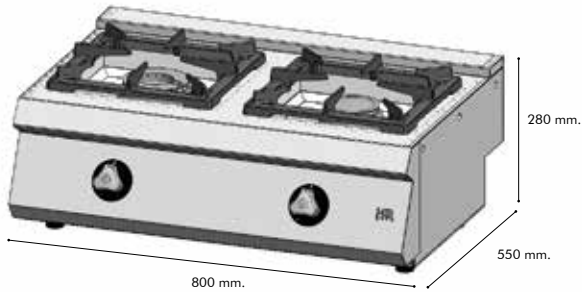
C2F550S**Cocina 2 fuegos 550 sobremesa.**

2 Burner hob 550 countertop.
Dessus de cuisson 2 feux-gamme 550.

P.V.P**975 €****12 KW****Kcal / h:** 10.320**Peso:** 32 Kg.

7,5 KW

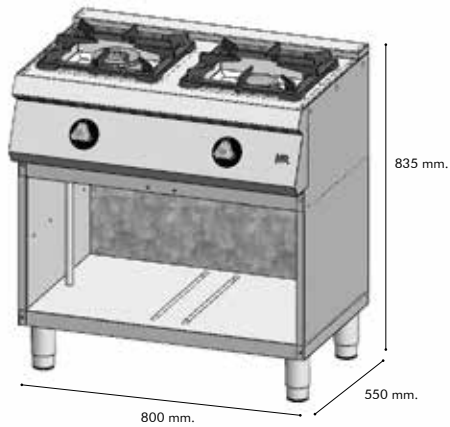

4,5 KW

C2F550E**Cocina 2 fuegos 550 estante.**

2 Burner hob 550 with shelf.
Cuisinière gaz 2 feux avec étagère-550.

P.V.P**1.145 €****12 KW****Kcal / h:** 10.320**Peso:** 49 Kg

7,5 KW

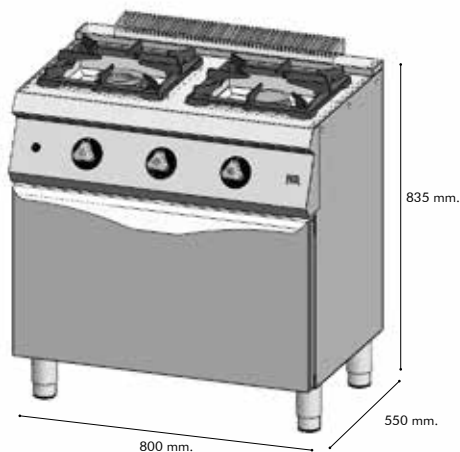

4,5 KW

C2F550H**Cocina 2 fuegos 550 horno.**

2 Burner hob 550 oven.
Cuisinière gaz 2 feux avec étagère 550.

P.V.P**1.750 €****18 KW****Kcal / h:** 15.480**Peso:** 70 Kg.

7,5 KW



4,5 KW



6 KW



KIT DE LIMPIEZA POR AGUA

SERIE 550

110003105	KIT DE LIMPIEZA POR AGUA 800	PVP 250 €
110003106	KIT DE LIMPIEZA POR AGUA 1200	PVP 300 €

SERIE 750 PAG. 64

110003104	KIT DE LIMPIEZA POR AGUA 400	PVP 230 €
110003105	KIT DE LIMPIEZA POR AGUA 800	PVP 250 €
110003106	KIT DE LIMPIEZA POR AGUA 1200	PVP 300 €

- El kit se monta en fábrica bajo pedido, para los modelos de estante y horno.

- Provisto de grifo de llenado para la batea de la cocina y accionado en el frente.

- Válvula de desagüe con rebosadero en acero inoxidable 18/10.

- El Kit de agua permite una fácil limpieza de residuos.



C3F550S

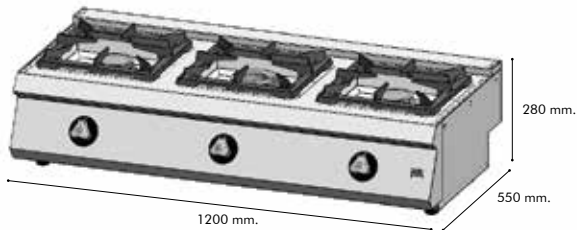

Cocina 3 fuegos 550 sobremesa.
3 Burner hob 550 countertop.
Dessus de cuisson 3 feux-gamme 550.

P.V.P

1.295 €

16,5 KW

Kcal / h: 14.190

Peso: 45 Kg.



4,5 KW



7,5 KW



4,5 KW

C3F550E

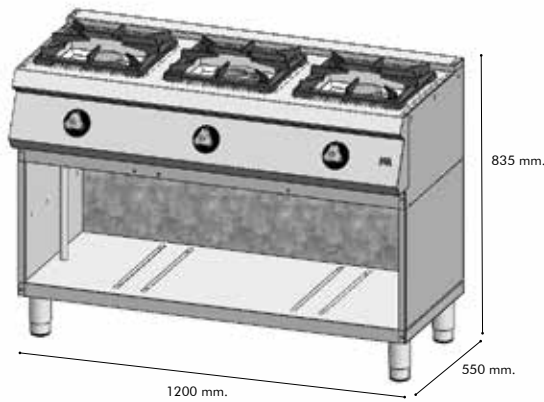

Cocina 3 fuegos 550 estante.
3 Burner hob 550 with shelf.
Cuisinière gaz 3 feux avec étagère-550.

P.V.P

1.535 €

16,5 KW

Kcal / h: 14.190

Peso: 69 Kg



4,5 KW



7,5 KW



4,5 KW

C3F550H

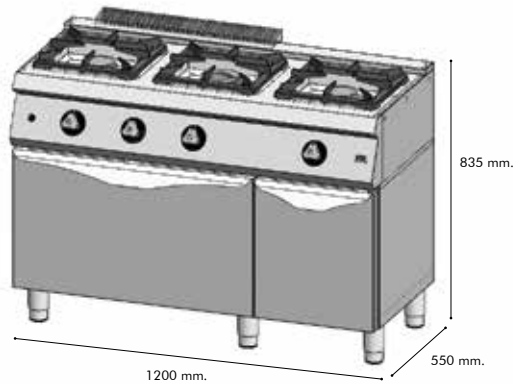

Cocina 3 fuegos 550 horno.
3 Burner hob 550 with shelf.
Cuisinière gaz 3 feux avec étagère-550.

P.V.P

2.210 €

22,5 KW

Kcal / h: 19.350

Peso: 93 Kg.



4,5 KW



7,5 KW



4,5 KW

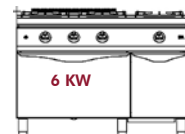



C4F750H

- Construcción en acero inoxidable.
Stainless steel construction.
Construction en acier inox.
- Fuegos superiores de gran rendimiento calorífico niquelado.
Burners of high heat performance nickel-plated.
Feux supérieurs à haut rendement calorifique nickelés.
- Guías del horno de fácil extracción para la limpieza del mismo.
Removable base plates for an easy cleaning.
Guides du four de facile retrait pour nettoyage.
- Horno con encendido piezo eléctrico.
Oven with piezo ignition.
Four avec allumage piézoélectrique.
- Válvula termostática de serie en el horno.
Standard thermostatic valve in the oven.
Robinet thermostatique de série dans le four.
- Parrilla superior fundición.
Cast iron grill.
Grille en fonte.
- Todos los quemadores incorporan llama piloto.
All burners incorporate pilot flame.
Tous les brûleurs sont dotés d'une flamme pilote.
- Termopar de seguridad.
Safety thermocouple.
Sécurité par thermocouple.
- Horno gastronorm 2/1
2/1 gastronorm oven
Four gastronorme 1/1.
- Nuevo tirador en acero inoxidable.
New stainless steel handle.
Nouvelle poignée en acier inoxydable.
- Parrilla horno antivuelco extraíble.
Removable roll grill oven.
Grill de rétention amovible.
- Altura mínima de chimenea para la utilización de cazuelas de gran diámetro.
Minimum height of chimney for the use of large diameter pots.
La hauteur minimale de la cheminée pour l'utilisation de cuves de grand diamètre.
- Patas de acero inoxidable regulables en altura.
Stainless steel legs with adjustable height.
Pieds inox réglables en hauteur.
- Burlete en fibra de vidrio, alta resistencia y gran eficiencia energética.
Gasket in fiberglass, high strength and high energy efficiency.
Joint en fibre de verre, haute résistance et à haute efficacité énergétique.

► Cambio de quemador de 4,5 Kw a 7,5 Kw
PVP 100 € por quemador (Bajo pedido).

C2F750S

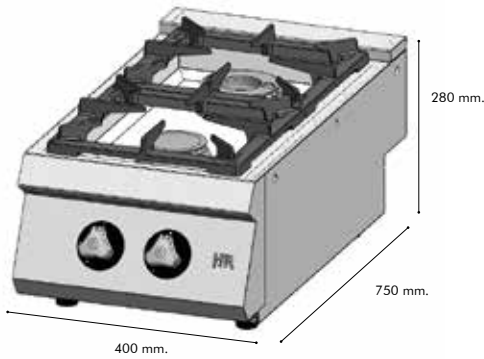

Cocina 2 fuegos 750 sobremesa.
 2 Burner hob 750 countertop.
 Dessus de cuisson 2 feux-gamme 750.

P.V.P

935 €

 **12 KW**

Kcal / h: 10.320

Peso: 27 Kg.



7,5 KW



4,5 KW

C2F750E

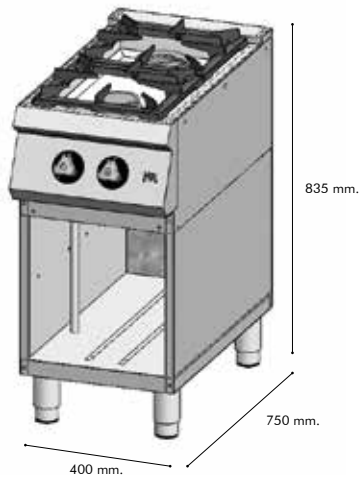

Cocina 2 fuegos 750 estante.
 2 Burner hob 750 with shelf.
 Cuisinière gaz 2 feux avec étagère-750.

P.V.P

1.125 €

 **12 KW**

Kcal / h: 10.320

Peso: 43 Kg



7,5 KW



4,5 KW

C4F750S

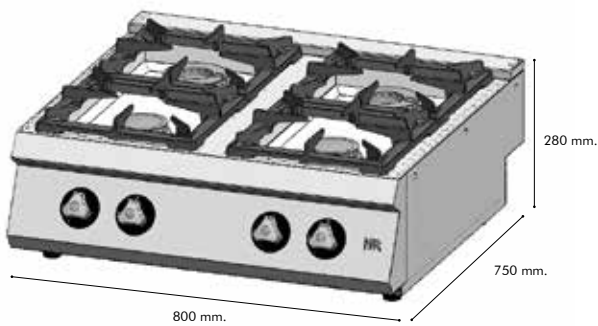

Cocina 4 fuegos 750 sobremesa.
 4 Burner hob 750 countertop.
 Dessus de cuisson 4 feux-gamme 750.

P.V.P

1.580 €

 **24 KW**

Kcal / h: 20.640

Peso: 49 Kg.



7,5 KW



7,5 KW



4,5 KW



4,5 KW



KIT DE LIMPIEZA POR AGUA / REF. y Características Pag. 44

C4F750E

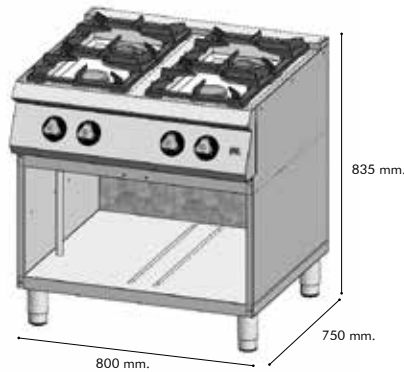

Cocina 4 fuegos 750 estante.
4 Burner hob 750 countertop.
Dessus de cuisson 4 feux-gamme 750.

P.V.P

1.790 €

 **24 KW**

Kcal / h: 20.640

Peso: 71 Kg.

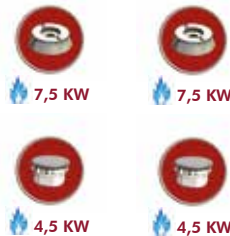

C4F750H

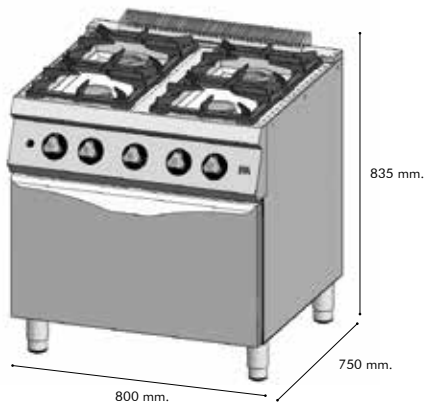

Cocina 4 fuegos 750 horno.
4 Burner hob 750 with shelf.
Cuisinière gaz 4 feux avec étagère-750.

P.V.P

2.375 €

 **32 KW**

Kcal / h: 27.550

Peso: 94 Kg



C6F750S

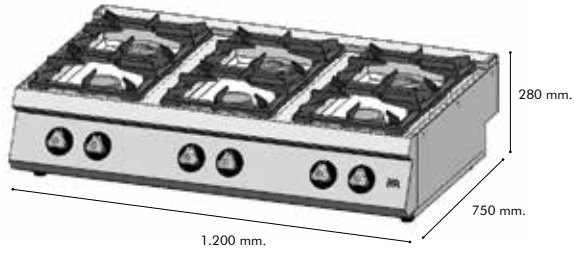

Cocina 6 fuegos 750 sobremesa.

6 Burner hob 750 counter top.
Dessus de cuisson 6 feux-gamme 750.

P.V.P.

2.205 €



36 KW

Kcal / h: 30.960

Peso: 71 Kg.



7,5 KW



7,5 KW



7,5 KW



4,5 KW



4,5 KW



4,5 KW

C6F750E

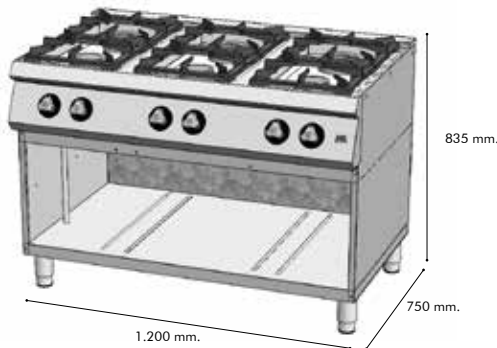

Cocina 6 fuegos 750 estante.

6 Burner hob 750 with shelf.
Cuisinière gaz 6 feux avec étagère 750.

P.V.P.

2.525 €



36 KW

Kcal / h: 30.960

Peso: 101 Kg.



7,5 KW



7,5 KW



7,5 KW



4,5 KW



4,5 KW



4,5 KW

C6F750H

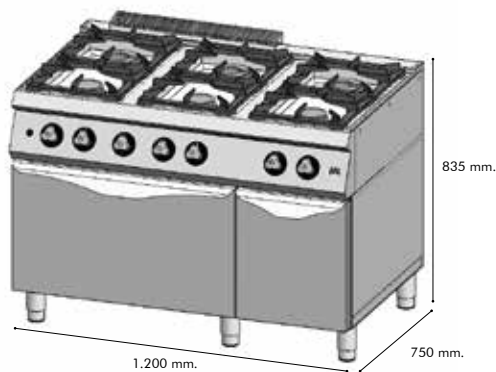

Cocina 6 fuegos 750 horno.

6 Burner hob 750 with shelf.
Cuisinière gaz 6 feux avec étagère 750

P.V.P.

3.270 €



44 KW

Kcal / h: 37.840

Peso: 127 Kg.



7,5 KW



7,5 KW



7,5 KW



4,5 KW



4,5 KW



4,5 KW

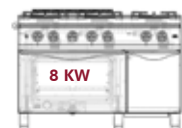



▶ FG2ECON



- Permiten la preparación rápida de alimentos.
It allow fast food preparation,
Facile préparation des aliments.
- Fácil limpieza.
Easy cleaning.
Facile nettoyage.
- Parrilla extraíble en acero cromado.
Removable grill in chromed steel.
Grille amovible en acier chromé.
- Cuerpo en acero inoxidable.
Stainless steel construction.
Corps en acier inoxydable.
- Termopar de seguridad.
Safety thermocouple.
Thermocouple de sécurité.
- Patas regulables en altura.
Adjustable legs in height.
Pattes ajustables.
- Toma de gas intercambiable de lado.
Interchangeable gas taking of side.
Prise de gaz interchangeable de côté.

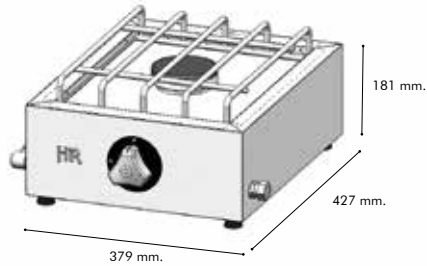

FG1ECON**Fogón 1 quemador económico.**

Economic 1 Burner Stove.

Fourneau 1 Brûleur Économique.

P.V.P**199 €****3,3 KW****Kcal / h: 2.838****Peso: 6 Kg.**

3,3 KW

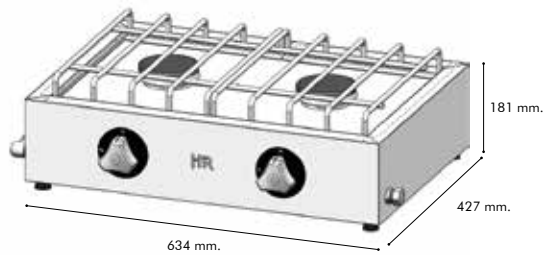
FG2ECON**Fogón 2 quemadores económico.**

Economic 2 Burner Stove.

Fourneau 2 Brûleur Économique.

P.V.P**320 €****6,6 KW****Kcal / h: 5.676****Peso: 9 Kg**

3,3 KW

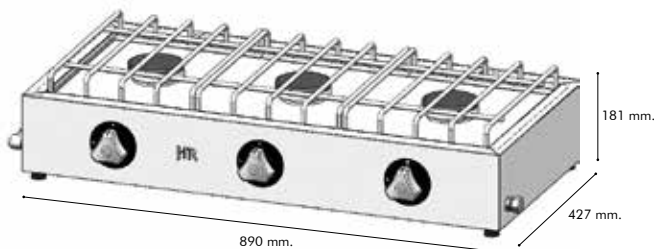

3,3 KW

FG3ECON**Fogón 3 quemadores económico.**

Economic 3 Burner Stove.

Fourneau 3 Brûleur Économique.

P.V.P**450 €****9,9 KW****Kcal / h: 8.514****Peso: 12 Kg.**

3,3 KW



3,3 KW



3,3 KW



+ COOKING

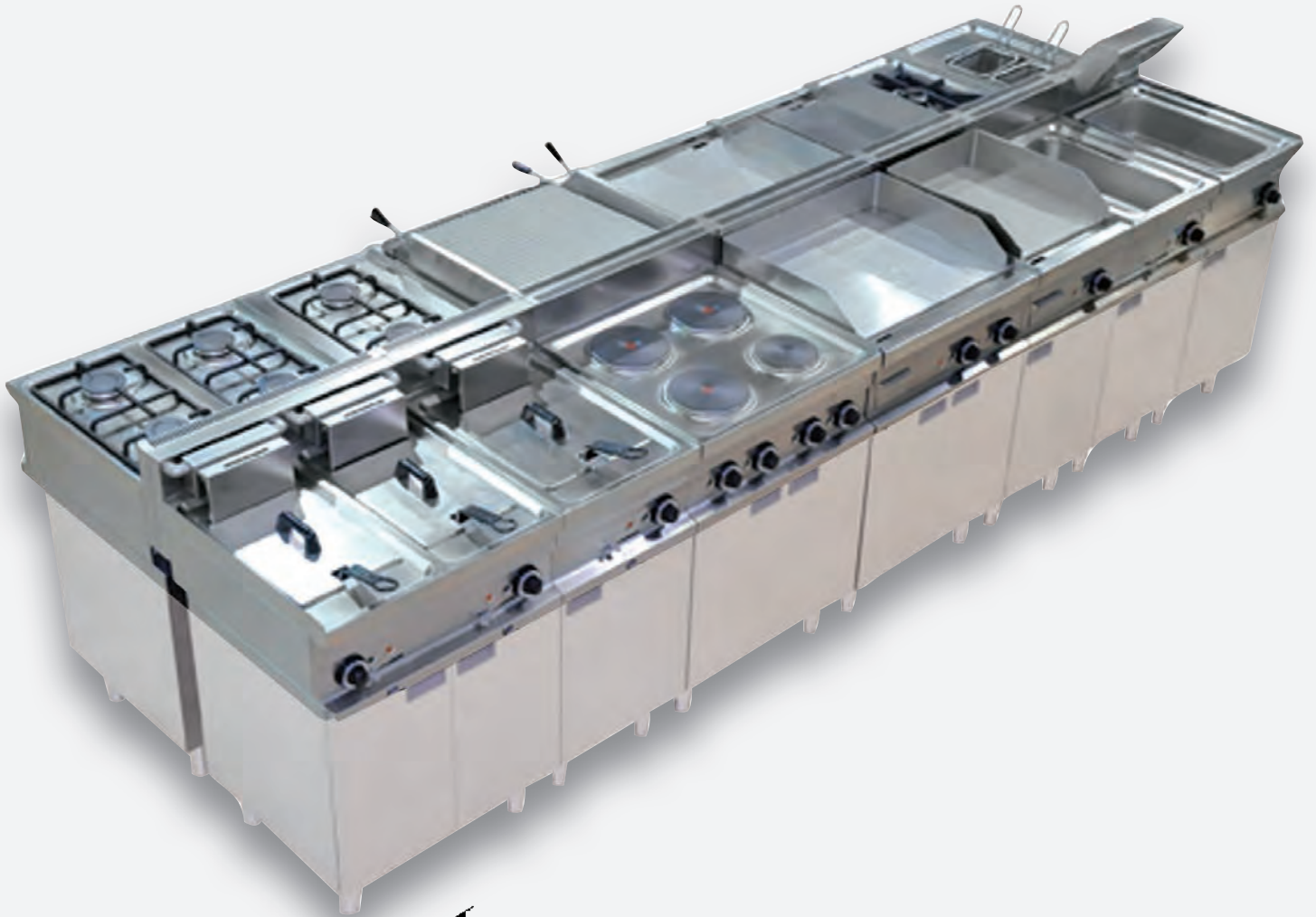

COCINAS 600 SNACK:

Especialmente pensadas para instalaciones en espacios reducidos, la serie 600 SNACK ofrece una completísima gama de elementos modulares que permitirán diseñar su cocina exactamente como usted la necesita.

La combinación de aquellos módulos que usted precise dará como resultado una cocina con todas las prestaciones necesarias para satisfacer al más exigente profesional.

Fabricadas con cuerpo de acero inoxidable, con encimera estampada y bordes suaves para facilitar la limpieza.

Dentro de la serie 600 SNACK encontrará todos los elementos necesarios para equipar la más completa cocina: módulos de quemadores a gas, eléctricos, planchas eléctricas y a gas, parrillas lava, baños maría, freidoras, cocedoras de pasta, etc...

Vea la amplia gama de elementos en pág.: 55 a 64.

MODELOS NEUTROS 600 SNACK



+ COOKING

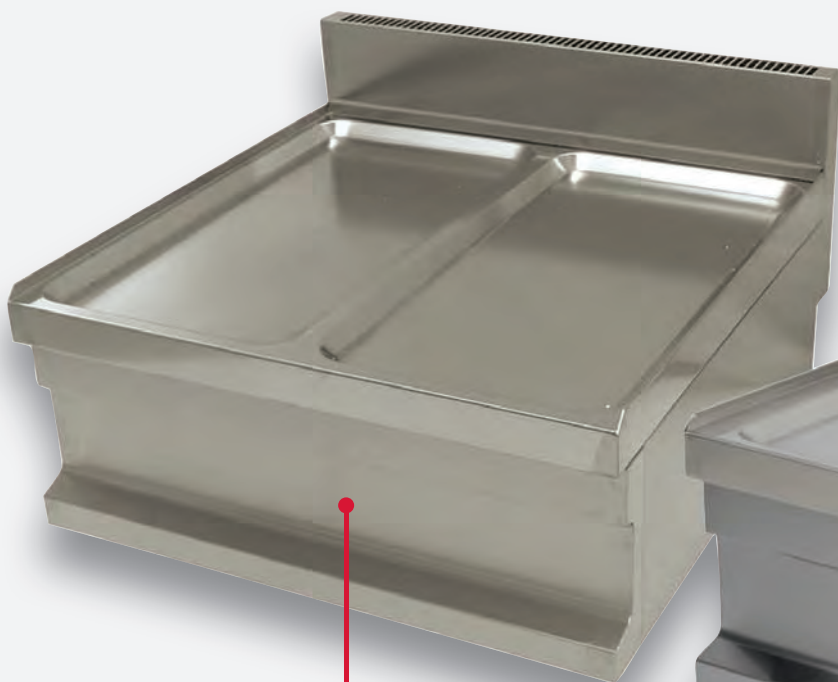

Mod. **6 S 6 NE**

Cuerpo de acero inoxidable.



Mod. **6 S 4 NE**

Encimera estampada y bordes suaves para facilitar la limpieza.



6S		4 NE	6 NE
Ancho	mm	400	600
Fondo	mm	600	600
Alto	mm	365	365
P.V.P. €			



+ COOKING



Mod. 6 S 4 CUG 1 F



Mod. 6 S 4 CUG 2 F

Mod. 6 S 6 CUG 4 F



Cuerpo de acero inoxidable.

Preparadas para gas ciudad, se sirven con chicles para gas butano

Encimera estampada y bordes suaves para facilitar la limpieza.

Equipadas con válvula de seguridad y termostato, que corta el gas en caso de que se apague la llama.

6S		4 CUG1F	4 CUG2F	6 CUG4F
Ancho	mm	400	400	600
Fondo	mm	600	600	600
Alto	mm	365	365	365
Potencia calorífica	W	6.000	2 x 3.600	4 x 3.600
Potencia total	kcal/h	5.160	6.192	12.384
P.V.P. €				



+ COOKING



Mod. 6 S 6 CUE 4 F

Mod. 6 S 4 CUE 2 F

Cuerpo de acero inoxidable.

Termostatos de regulación y seguridad.

Encimera estampada y bordes suaves para facilitar la limpieza.



6S		4 CUE2F	6 CUE4F
Ancho	mm	400	600
Fondo	mm	600	600
Alto	mm	365	365
Potencia calorífica	W	2 x 2.000	3x2.000+1.000
Alimentación	V/fases	220/1	380/3
P.V.P. €			



 COOKING



COCINAS 700 SNACK:

La serie 700 SNACK ofrece la gama de cocinas profesionales ideal para aquellos que necesitan prestaciones y calidad en un espacio limitado.

En las páginas siguientes encontrará una pequeña muestra de la extensa gama de modelos disponibles.

Para más información no dude en contactar con nosotros.



+ COOKING

Quemadores con piloto, válvula de seguridad y termopar.



Pies regulables.



Mod. 7 P 8 CUG 4 F

Frontal y encimera de acero inoxidable AISI 310.

Preparadas para gas ciudad, se sirven con chicles para gas butano



Mod. 7 P 8 CUG 4 F+ HE

Laterales y horno de acero inoxidable AISI 430



7 P 8		CUG4F	CUG4F+HE	CIG4F+HG
Ancho	mm	800	800	800
Fondo	mm	700	700	700
Alto	mm	900	900	900
Capacidad bandejas horno		-	4	4
Distancia entre bandejas horno	mm	-	50	50
Ventiladores horno		-	1	-
Temperatura horno	°C	-	350	350
Potencia calorífica fogones	W	4 x 6.000	4 x 6.000	4 x 6.000
Potencia total fogones	kcal/h	20.636	20.636	20.636
Potencia horno	W	-	3.000	6.000
Alimentación	V/fases	-	220/1	-

P.V.P. €



+ COOKING

Quemadores con piloto, válvula de seguridad y termopar.



Pies regulables.



Mod. 7 P 12 CUG 6 F

Frontal y encimera de acero inoxidable AISI 310.

Preparadas para gas ciudad, se sirven con chicles para gas butano



Mod. 7 P 12 CUG 6 F + HE

Laterales y horno de acero inoxidable AISI 430













7 P12		CUG6F	CUG6F+HE
Ancho	mm	1.200	1.200
Fondo	mm	700	700
Alto	mm	900	900
Capacidad bandejas horno		-	4
Distancia entre bandejas horno	mm	-	50
Ventiladores horno		-	1
Temperatura horno	°C	-	350
Potencia calorífica fogones	W	6 x 6.000	6 x 6.000
Potencia total fogones	kcal/h	30.966	30.966
Potencia horno	W	-	3.000
Alimentación	V/fases	-	220/1

P.V.P. €

650 ÚNICO

(ANCHO ESPECIAL 35/70)

MÁQUINA	MODELO	DIMENSIONES	POTENCIA KW	T	VOLTAJE	PVP
 2 F TOP <i>Quemadores de 90mm y 120 mm ø con termocopia</i>	6UCBG02	35x63x29	6+3,5	9,5		835€
 4 F TOT <i>Quemadores de 90mm y 120 mm ø con termocopia</i>	6UCBG04	70x63x29	2x6+2x3,5	19		1.299€
 4 F + HORNO GAS	6UCBG14FG	70x63x90	2x6+2x3,5+6	23		2.575€
4 F + HORNO ELECTRICO <i>Horno GN 1/1. El eléctrico es ventilado 230v Suplemento encendido eléctrico del plano de cocción (c/ 2 f) : 60 €</i>	6UCBG14FV	70x63x90	2x6+2x3,5+3	19	230V 1F+N	2.620€
 FRY TOP GAS 35 LISO	6UFTG35LB	35x63x29	6	6	Plancha 34x51	1.025€
FRY TOP 35 LISO CROMO <i>Opcional peto antisalpicaduras. 2 quemadores x mando permite alcanzar más de 300°C</i>	6UFTG35LC	35x63x29	6	6	Plancha 34x51	1.550€ 90€
 FRY TOP GAS 70 LISO	6UFTG70LB	70x63x29	6 + 6	12	Plancha 69x57	1.495€
FRY TOP GAS 70 LISO CROMO	6UFTG 70 LC	70x63x29	6 + 6	12	Plancha 69x57	1.985€
FRY TOP GAS 70 LISO-RIZADO <i>Opcional peto antisalpicaduras. 2 quemadores x mando permite alcanzar más de 300°C</i>	6UFTG70LR	70x63x29	6 + 6	12	Plancha 69x57	1.835€ 110€
 FREIDORA GAS 8 LIT TOP <i>Quemadores fuera de la cuba "cuba limpia"</i>	6UFRG08	35x63x29	6	6		1.645€
 FREIDORA GAS 8+8 LIT TOP <i>Quemadores fuera de la cuba "cuba limpia"</i>	6UFRG16	70x63x29	6 + 6	12		2.810€
MÁQUINA	MODELO	DIMENSIONES	POTENCIA KW	T	VOLTAJE	PVP
 2 PLACAS TOP <i>Placas de 180 mm ø</i>	6UCTEM02	35x63x29	2x2	4	230V F+N	720€
 4 PLACAS TOP	6UCTEM04	70x63x29	4x2	8	230V F+N	1.135€
 4 PLACAS + HORNO ELEC <i>Horno GN 1/1 de 3 kw ventilado</i>	6UCTE14FV	70x63x90	4x2+3	11	400V 3F+N	2.455€
 FRY TOP ELECT 35 LISO	6UFTE35B	35x63x29	3,6	3,6	230V F+N	1.070€
FRY TOP ELECT 35 LISO CROMO <i>Opcional peto antisalpicaduras. Plancha de 34x51. 2 quemadores x mando permite alcanzar más de 300°C</i>	6UFTE35MLBC	35x63x29	3,6	3,6	230V F+N	1.495€ 90€

700 ÚNICO POTENCIADAS

(COMBINABLE CON GAMA STILE)

	MÁQUINA	MODELO	DIMENSIONES	POTENCIA KW	T	VOLTAJE	PVP
	ENCIMERA 2 F POTENCIADA	E7TCG02	40x73x29	2x10	20		1.240€
	ENCIMERA 4 F POTENCIADA	E7TCG04	80x73x29	4x10	40		1.995€
	ENCIMERA 6 F POTENCIADA	E7TCG06	120x73x29	6x10	60		2.830€
	COCINA 2 F BAJO LIBRE POTENCIADA	E7CBG02	40x73x90	2x10	20		1.395€
	COCINA 4 F BAJO LIBRE POTENCIADA	E7CBG04	80x73x90	4x10	40		2.235€
	COCINA 6 F BAJO LIBRE POTENCIADA	E7CBG06	120x73x90	6x10	60		3.055€
	COCINA 4 F + HORNO GAS 2/1 POTENCIADA	E7CBG14	80x73x90	4x10 + 7,7	47,7		3.430€
	<i>Horno GN 1/1 de 4 kw con grill de gas</i>						
	COCINA 6 F + HORNO MAXI POTENCIADA	7PCHG61G	120x73x90	6x10+9,2	69,2		4.665€
	<i>Dimensiones del horno: 97x65x36</i>						

Los quemadores pueden ser también de 6 Kw. a voluntad.
Cubeta extraíble. Bandeja recoge grasas. Llama piloto

OPCIONALES

Encendido eléctrico	150€
Puerta 40 (especificar derecha/izquierda)	197€
Kit puerta 80 (2)	399€
Kit puerta 120 (3)	468€
Chimenea a juego con estética Stile (40)	47€
Chimenea a juego con estética Stile (80)	73€
Chimenea a juego con estética Stile (120)	89€

700 ÚNICO

COMBINABLE CON GAMA STILE ***DISPONIBLE TAMBIEN EN ANCHO 35/70***



MÁQUINA	MODELO	DIMENSIONES	POTENCIA KW	T	VOLTAJE	PVP
---------	--------	-------------	-------------	---	---------	-----



4 F BAJO LIBRE	U7CBG04	80x73x90	3x6+1x3,5	21,5		1.895€
-----------------------	----------------	----------	-----------	------	--	---------------

6 F BAJO LIBRE	U7CBG06	120x73x90	5x6+1x3,5	33,5		2.850€
-----------------------	----------------	-----------	-----------	------	--	---------------

Quemadores de 90mm y 120 mm diam con termocopia
Suplemento encendido eléctrico del plano de cocción: 120 € (4 fuegos) y 185 (6 fuegos) en todos los modelos



4 F + HORNO GAS 1/1	U7CBG14FG	80x73x90	3x6+1x3,5+4	25,5		2.880€
----------------------------	------------------	----------	-------------	------	--	---------------

4 F + HORNO GAS 2/1	U7CBG14	80x73x90	3x6+1x3,5+7,7	29,2		3.100€
----------------------------	----------------	----------	---------------	------	--	---------------

Horno 1/1 de 4 niveles y 2/1 de 3 niveles. Disponible opciones con horno eléctrico (1/1) ventilado y 2/1 estático.
Quemadores de 90mm y 120 mm diam con termocopia.



6 F + HORNO GAS 2/1	U7CBG16	120x73x90	5x6+1x3,5+7,7	41,2		3.860€
----------------------------	----------------	-----------	---------------	------	--	---------------

6 F + HORNO GAS MAXI	U7CBG16XL	120x73x90	3x6+1x3,5+9,2	42,7		4.230€
-----------------------------	------------------	-----------	---------------	------	--	---------------

Dimensiones horno Maxi: 970x630x365. Quemadores de 90mm y 120 mm diam con termocopia.
Disponible horno eléctrico estático 2/1.
Los hornos eléctrico además disponen de grill.



FRY TOP GAS 40 LISO	U7FTG40L	40x73x90	7	7		1.715€
----------------------------	-----------------	----------	---	---	--	---------------

Opcional peto anti salpicaduras **100€**
Dimensiones plancha: 360x570x120. Puertas opcionales.
2 quemadores x mando permite alcanzar más de 300°C.



FRY TOP GAS 80 LISO	U7FTG80L	80x73x90	7 + 7	14		2.455€
----------------------------	-----------------	----------	-------	----	--	---------------

FRY TOP GAS 80 LR	U7FTG80LR	80x73x90	7 + 7	14		2.475€
--------------------------	------------------	----------	-------	----	--	---------------

Opcional peto anti salpicadura. **130€**
Dimensiones plancha: 755x570x120. Versión cromo = ver gama 700 "Stile"
2 quemadores x mando permite alcanzar más de 300°C. Puertas opcionales.



FREIDORA GAS 15 LIT	U7FRG13	40x73x90	12	12		2.345€
----------------------------	----------------	----------	----	----	--	---------------

FREIDORA GAS 15 + 15 LIT	U7FRG26	80x73x90	12 + 12	24		4.035€
---------------------------------	----------------	----------	---------	----	--	---------------

En dotación 1 cubeta recoge-aceite x máquina + cestos
Dimensiones de la cuba: 240x345x266











CUECEPASTAS GAS 40	U7CPG35	40x73x90	10,5	10,5		2.885€
---------------------------	----------------	----------	------	------	--	---------------

Cuba GN 2/3. 35 lit en inox AISI 316. Quemadores de tungsteno
Cestos no incluidos

700 STILE

(DISPONIBLE TAMBIÉN EN ANCHO 35/70)

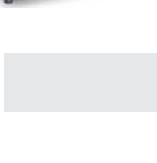

MÁQUINA	MODELO	DIMENSIONES	POTENCIA KW	T	VOLTAJE	PVP
 2 F TOP	7TCG2	40x73x27	6,5+4,5	11		1.375€
 4 F TOP	7TCG4	80x73x27	2x6,5+2x4,5	22		2.180€
 6 F TOP	7TCG6	120x73x27	3x6,5+3x4,5	35		3.110€
 2 F BAJO LIBRE	7CBG02	40x73x90	6,5+4,5	11		1.540€
 4 F BAJO LIBRE	7CBG04	80x73x90	2x6,5+2x4,5	22		2.385€
 6 F BAJO LIBRE	7CBG06	120x73x90	3x6,5+3x4,5	35		3.335€
 4 F + HORNO	7CBG14	80x73x90	2x6,5+2x4,5+7,7	29,7		3.595€
<i>Horno GN 2/1</i>						
 6 F + HORNO CENTRO	7CBG16	120x73x90	3x6,5+3x4,5+7,7	40,7		4.515€
 6 F + HORNO + ARMARIO	7CBG26	120x73x90	3x6,5+3x4,5+7,7	40,7		4.815€
<i>Horno GN 2/1</i>						
 6 F + HORNO MAXI	7CBG16XL	120x73x90	3x6,5+3x4,5+9,2	42,2		4.875€
<i>Horno 975x650x365 (3/1) Disponible en toda la gama de cocinas, hornos eléctricos y armario caliente</i>						
MUEBLE PAELLERO	7P12	80x79x90	12	12		2.990€
PALASTRO TOP	7TTG80	80x73x27	11,7	11,7		2.310€
PALASTRO BAJO LIBRE	7TPG00	80x73x90	11,7	11,7		2.590€
PALASTRO CON HORNO	7TPG10	80x73x90	11,7+7,7	19,4		3.990€
PALASTRO +2F Y HORNO	7TPG22	120x73x90	5,5+3,5+11,7+7,7	27,4		5.355€

(DISPONIBLE TAMBIÉN EN ANCHO 35/70)

MÁQUINA	MODELO	DIMENSIONES	POTENCIA KW	T	VOLTAJE	PVP
---------	--------	-------------	-------------	---	---------	-----



COCINA WOK	7CBG01W	40x73x90	12	12		2.160€
-------------------	----------------	----------	----	----	--	---------------

NOVEDAD



CUECEPASTAS 30 L MUEBLE	7CPG30	40x73x90	10	10		3.040€
CUECEPASTAS 60 L MUEBLE	7CPG60	80x73x90	10+10	20		5.145€

Cestos nos incluidos en dotación. Quemadores externos a la cuba. Cubas GN 2/3, en Aisi 316.



FREIDORA 13 LIT MUEBLE	7FRG13	40x73x90	12	12		2.730€
FREIDORA 17 LIT MUEBLE	7FRG17	40x73x90	18	18		3.095€

Quemadores tubulares dentro de la cuba. Control mecánico. En dotación 1 cesto + 1 cubeta recoge-aceite.



FREIDORA 8+8 LIT MUEBLE	7FRG16	40x73x90	6+6	12		3.880€
--------------------------------	---------------	----------	-----	----	--	---------------

Especial para espacios reducidos. Quemadores tubulares dentro de la cuba. Control mecánico.



FREIDORA 13+13 LIT MUEBLE	7FRG26	80x73x90	12+12	24		4.710€
FREIDORA 17+17 LIT MUEBLE	7FRG34	80x73x90	18+18	36		5.490€

En dotación 1 cesto grande+ 2 pequeños + 1 cubeta recoge-aceite. Quemadores tubulares dentro de la cuba. Control mecánico.



FREIDORA CUBA LIMPIA 13 LIT	7 FRG13VP	40x73x90	12	12		2.965€
FREIDORA CUBA LIMPIA 17 LIT	7 FRG17VP	40x73x90	16	16		3.200€

En dotación 1 cesto + 1 cubeta recoge-aceite. Quemadores en acero inox fuera de la cuba.

FREIDORA CUBA LIMPIA 13+13 LIT	7 FRG26VP	80x73x90	12+12	24		5.284€
FREIDORA CUBA LIMPIA 17+17 LIT	7 FRG34VP	80x73x90	16+16	32		5.495€

En dotación 1 cesto grande+ 2 pequeños + 1 cubeta recoge-aceite. Quemadores en acero inox fuera de la cuba.



FREIDORA RAPIDA 17 LIT	7 FRG17R	40x73x90	18	18		3.660€
-------------------------------	-----------------	----------	----	----	--	---------------

En dotación 1 cesto + 1 cubeta recoge-aceite. Quemadores tubulares dentro de la cuba. Control electrónico. Precisión +/- 1°C

FREIDORA RAPIDA 17+17 LIT	7 FRG34R	80x73x90	18+18	36		6.415€
----------------------------------	-----------------	----------	-------	----	--	---------------

En dotación 1 cesto grande+ 2 pequeños + 1 cubeta recoge-aceite. Quemadores tubulares dentro de la cuba. Control electrónico. Precisión +/- 1°C.

***** los modelos 13 cuentan con cuba de 20 litros y los 17, de 25 lit******











FREIDORA SUPER RAPIDA SUPERMIX-17	7FRG17 HP	40x73x90	16	16		5.395€
--	------------------	----------	----	----	--	---------------

Super rápida programable. Con cuba limpia. Precisión +/- 1°C. Quemador ventilado. Carga aconsejada: 2 kg. Producción 30 Kg/h. Permite regular tiempo y temperatura. Programa de lavado. Indica horas de utilización del aceite. Cuando no fríe se sitúa automáticamente en 100° para economizar. Avisador acústico de fin de ciclo, necesidad de cambio de aceite o avería.



*** (DISPONIBLE TAMBIÉN EN ANCHO 35/70) ***

MÁQUINA	MODELO	DIMENSIONES	POTENCIA KW	T	VOLTAJE	PVP	
	COCINA 2 PLACAS BAJO LIBRE	7CTE02	40x73x90	2,6x2	5,2	400V 3F+N	1.430€
	COCINA 4 PLACAS BAJO LIBRE	7CTE04	80x73x90	2,6x4	10,4	400V 3F+N	1.990€
	COCINA 6 PLACAS BAJO LIBRE	7CTE06	120x73x90	2,6x6	15,6	400V 3F+N	2.615€
<i>Placas de 22 cm de diámetro. Puerta no incluida en precio.</i>							
	COCINA 4 PLACAS+ HORNO	7CTE14	80x73x90	2,6x4+5,5	15,9	400V 3F+N	3.770€
	COCINA 6 PLACAS+ HORNO Y ARMARIO	7CTE16	120x73x90	2,6x6+5,5	21,1	400V 3F+N	4.360€
	COCINA VITRO 2 PLACAS TOP	7TCE2V	40x73x27	1,8+2,5	4,3	400V 3F+N	2.230€
	COCINA VITRO 4 PLACAS TOP	7TCE4V	80x73x27	2x1,8+2x2,5	8,6	400V 3F+N	3.390€
<i>Cristal de 6mm de 34x56,5. La placa pequeña (ø20) es de potencia fija. La grande (ø15 potencia 1 KW y ø0,25 potencia 2,5 KW)</i>							
	COCINA WOK DE INDUCCIÓN	7CIE01W	40x73x90	8	8	400V 3F+N	6.795€
<i>ø 30 cm</i>							
							NOVEDAD
	CUECEPASTAS 30 L MUEBLE	7CPE30A	40x73x90	7	7	400V 3F+N	3.015€
	CUECEPASTAS 60 L MUEBLE	7CPE60A	80x73x90	14	14	400V 3F+N	5.195€
<i>Cestos nos incluidos en dotación. Resistencia externa a la cuba. Cubas GN 2/3, en Aisi 316</i>							
	FREIDORA 13 LIT ELEC MUEBLE	7FRE13	40x73x90	12	12	400V 3F+N	2.395€
	FREIDORA 17 LIT ELEC MUEBLE	7FRE17	40x73x90	17	17	400V 3F+N	2.675€
<i>En dotación 1 cesto + 1 cubeta recoge-aceite. Resistencias giratorias en todos los modelos</i>							
	FREIDORA 8+8 LIT ELEC MUEBLE	7FRE16	40x73x90	14	14	400V 3F+N	3.400€
<i>Especial para espacios reducidos. Resistencias giratorias.</i>							
	FREIDORA 13+13 LIT ELEC MUEBLE	7FRE26	80x73x90	24	24	400V 3F+N	4.235€
	FREIDORA 17+17 LIT ELEC MUEBLE	7FRE34	80x73x90	34	34	400V 3F+N	4.510€
<i>En dotación 1 cesto grande+ 2 pequeños + 1 cubeta recoge-aceite. Resistencias giratorias</i>							
	FREIDORA RAPIDA 17 LIT	7 FRE17R	40x73x90	16,5	16,5	400V 3F+N	3.210€
<i>Control electrónico. Precisión +/- 1°C. En dotación 1 cesto + 1 cubeta recoge-aceite</i>							
	FREIDORA RAPIDA 17+17 LIT	7 FRE34R	80x73x90	33	33	400V 3F+N	5.515€
<i>Control electrónico. Precisión +/- 1°C. En dotación 1 cesto grande+ 2 pequeños + 1 cubeta recoge-aceite</i>							
<i>Electrónica. Programable en tiempo y temperatura. Precisión +/- 1°C. Cuba limpia. Quemador inducido radiante. Aviso sonoro cuando alcanza el tiempo programado, si necesita cambiar el aceite, en caso de avería,...</i>							
<i>Dispone de función de trabajo rápido o económico.</i>							

*** Los modelos 13 cuentan con cuba de 20 litros y los 17, de 25 lit****

900 ÚNICO POTENCIADAS

***COMBINABLE CON GAMA STILE

C

MÁQUINA	MODELO	DIMENSIONES	POTENCIA KW	T	VOLTAJE	PVP
---------	--------	-------------	-------------	---	---------	-----



ENCIMERA 2 F POTENCIADA	E8TCG02	40x90x29	2 x 10	20		1.460€
-------------------------	---------	----------	--------	----	--	--------



ENCIMERA 4 F POTENCIADA	E8TCG04	80x90x29	4 x 10	40		2.368€
-------------------------	---------	----------	--------	----	--	--------



ENCIMERA 6 F POTENCIADA	E8TCG06	120x90x29	6 x 10	60		3.129€
-------------------------	---------	-----------	--------	----	--	--------

Suplemento encendido eléctrico del plano de cocción: 120 € (4 fuegos) y 185 € (6 fuegos) en todos los modelos



COCINA 2 F BAJO LIBRE POTENCIADA	E8CBG02	40x90x90	2 x 10	20		1.565€
----------------------------------	---------	----------	--------	----	--	--------



COCINA 4 F BAJO LIBRE POTENCIADA	E8CBG04	80x90x90	4 x 10	40		2.465€
----------------------------------	---------	----------	--------	----	--	--------



COCINA 6 F BAJO LIBRE POTENCIADA	E8CBG06	120x90x90	6 x 10	60		3.255€
----------------------------------	---------	-----------	--------	----	--	--------

Suplemento encendido eléctrico del plano de cocción: 120 € (4 fuegos) y 185 € (6 fuegos) en todos los modelos



COCINA 4 F + HORNO GAS 2/1 POTENCIADA	E8CBG14	80x90x90	4 x 10 + 7,7	47,7		3.560€
---------------------------------------	---------	----------	--------------	------	--	--------



COCINA 6 F + HORNO GAS MAXI POTENCIADA	E8CBG16XL	120x90x90	6 x 10 + 9,2	69,2		5.090€
--	-----------	-----------	--------------	------	--	--------

Dimensiones horno Maxi: 97x63x36

Los quemadores pueden ser también de 6 Kw. a voluntad. Cubeta extraíble. Bandeja recoge-grasas. Llama piloto







OPCIONALES

- Chimenea a juego con estética Stile (40)	47€
- Chimenea a juego con estética Stile (80)	73€
- Chimenea a juego con estética Stile (120)	89€
- Puerta 40 (especificar derecha/izquierda)	197€
- Kit puerta 80 (2)	399€
- Kit puerta 120 (3)	468€















980 STILE

*** (DISPONIBLE TAMBIEN EN ANCHO 45/90) ***



MÁQUINA	MODELO	DIMENSIONES	POTENCIA KW	T	PVP	
	COCINA 2 F TOP	8TCG2	40x90x27	8,5+5,5	14	1.625€
	COCINA 4 F TOP	8TCG4	80x90x27	1x8,5+2x5,5+1x3,5	23	2.595€
	COCINA 6 F TOP	8TCG6	120x90x27	2x8,5+2x5,5+2x3,5	35	3.565€
	<i>Ver ubicación y posibilidad de potenciar quemadores en opcionales</i>					
	COCINA 2 F BAJO LIBRE	8CBG02	40x90x90	8,5+5,5	14	1.895€
	COCINA 4 F BAJO LIBRE	8CBG04	80x90x90	1x8,5+2x5,5+1x3,5	23	2.895€
	COCINA 6 F BAJO LIBRE	8CBG06	120x90x90	2x8,5+2x5,5+2x3,5	35	3.895€
	<i>Ver ubicación y posibilidad de potenciar quemadores en opcionales</i>					
	COCINA 4 F + HORNO	8CBG14	80x90x90	1x8,5+2x5,5+1x3,5+7,7	30,7	4.195€
	COCINA 6 F + HORNO CENTRO	8CBG16	120x90x90	2x8,5+2x5,5+2x3,5+7,7	42,7	5.285€
	COCINA 6 F + HORNO + ARMARIO	8CBG26	120x90x90	2x8,5+2x5,5+2x3,5+7,7	42,7	5.570€
	<i>Ver ubicación y posibilidad de potenciar quemadores en opcionales</i>					
	COCINA 6 F + HORNO MAXI	8CBG16XL	120x90x90	2x8,5+2x5,5+2x3,5+9,2	44,2	5.570€
	<i>Horno 975x650x365</i>					
	<i>Cocina 8 fuegos. MURAL: por encargo</i>					
	<i>Ver ubicación y posibilidad de potenciar quemadores en opcionales</i>					
	PASANTE 4F BAJO LIBRE	9CBG04P	90x90x90	1x8,5+2x5,5+1x3,5	23	3.755€
	PASANTE 6F BAJO LIBRE	9CBG06P	135x90x90	2x8,5+2x5,5+2x3,5	35	4.985€
	PASANTE 8F BAJO LIBRE	9CBG08P	180x90x90	2x8,5+4x5,5+2x3,5	46	7.995€
	<i>Quemadores de mandos cocina en los dos lados.</i>					
	PASANTE 4F + HORNO	9CBG24P	90x90x90	1x8,5+2x5,5+1x3,5	30,7	5.245€
	PASANTE 6F + HORNO	9CBG26P	135x90x90	2x8,5+2x5,5+2x3,5	42,7	6.425€
	PASANTE 8F + 2 HORNOS	9CBG28P	180x90x90	2x8,5+2x5,5+2x3,5+2x7,7	61,4	9.365€
	<i>Quemadores de mandos cocina en los dos lados. Apertura horno en los dos lados.</i>					
	MUEBLE PAELLERO	9P28	80x90x90	28	28	3.820€
	COCINA WOK	8CBG01W	40x90x90	12	12	2.325€

NOVEDAD

MÁQUINA	MODELO	DIMENSIONES	POTENCIA KW	T	VOLTAJE	PVP
 COCINA 2 PLACAS TOP	8TCE2Q	40x90x27	2x4	8	400V 3F+N	2.250€
 COCINA 4 PLACAS TOP	8TCE4Q	80x90x27	4x4	16	400V 3F+N	3.740€
 COCINA 6 PLACAS TOP	8TCE6Q	120x90x27	6x4	24	400V 3F+N	5.255€
 COCINA 2 PLACAS BAJO LIBRE	8CQE02	40x90x90	2x4	8	400V 3F+N	2.485€
 COCINA 4 PLACAS BAJO LIBRE	8CQE04	80x90x90	4x4	16	400V 3F+N	3.980€
 COCINA 6 PLACAS BAJO LIBRE	8CQE06	120x90x90	6x4	24	400V 3F+N	5.625€
 COCINA 4 PLACAS+ HORNO	8CQE14	80x90x90	4x4+5,5	21,5	400V 3F+N	5.825€
 COCINA 6 PLACAS+ HORNO Y ARMAR	8CQE26	120x90x90	6x4+5,5	29,5	400V 3F+N	7.746€
 COCINA VITRO 2 PLACAS TOP	8TCE2V	40x90x27	3,4x2	6,8	400V 3F+N	2.845€
 COCINA VITRO 4 PLACAS TOP	8TCE4V	80x90x27	3,4x4	13,6	400V 3F+N	4.185€
 COCINA VITRO 2 BAJO LIBRE	8CVE02	40x90x90	3,4x2	6,8	400V 3F+N	2.990€
 COCINA VITRO 4 BAJO LIBRE	8CVE04	80x90x90	3,4x4	13,6	400V 3F+N	4.430€
 COCINA INDUCCION TOP 2 PLACAS	8TCE2I	40x90x27	5x2	10	400V 3F+N	9.235€
 COCINA INDUCCION TOP 4 PLACAS	8TCE4I	80x90x27	5x4	20	400V 3F+N	16.715€
 COCINA INDUCCION 2 BAJO LIBRE	8CIE02	40x90x90	5x2	10	400V 3F+N	9.415€
COCINA INDUCCION 4 BAJO LIBRE	8CIE04	80x90x90	5x4	20	400V 3F+N	16.990€
COCINA WOK DE INDUCCIÓN Ø 30 cm	8CIE01W	40x90x90	8	8	400V 3F+N	6.795€
BAÑO M 40 TOP <i>Cuba GN 1/1+1/3. Cubetas no incluidas en precio</i>	8TBE40	40x90x27	1,5	1,5	230V F+N	1.895€
BAÑO M 80 TOP <i>Cuba 2 x (GN 1/1+1/3). Cubetas no incluidas en precio</i>	8TBE80	80x90x27	3	3	230V F+N	2.430€
BAÑO M 40 BAJO LIBRE <i>Cuba GN 1/1+1/3. Cubetas no incluidas en precio</i>	8BME40	40x90x90	1,5	1,5	230V F+N	2.100€
BAÑO M 80 BAJO LIBRE <i>Cuba 2 x (GN 1/1+1/3). Cubetas no incluidas en precio</i>	8BME80	80x90x90	3	3	230V F+N	2.695€

NOVEDAD



MÁQUINA	MODELO	DIMENSIONES	POTENCIA KW	T	VOLTAJE	PVP
---------	--------	-------------	-------------	---	---------	-----



COCINA 4 F	G4S9	90x90x25	8x1+6x2+3,5x1	23,5		2.645€
------------	------	----------	---------------	------	--	--------

COCINA 4 F POTENCIADOS	G4S948	90x90x25	8x4	32		2.720€
------------------------	--------	----------	-----	----	--	--------

COCINA 6 F	G6S9	135x90x25	8x2+6x2+3,5x2	35		3.680€
------------	------	-----------	---------------	----	--	--------



HORNILLO	SG1S9	90x90x25		12	12	2.695€
----------	-------	----------	--	----	----	--------

PAELLERO	PG9	90x90x25		27	27	3.200€
----------	-----	----------	--	----	----	--------



FRY TOP GAS 45 L	GFT49L	45x90x25		8	8	2.370€
------------------	--------	----------	--	---	---	--------

FRY TOP GAS 45 R	GFT49R	45x90x25		8	8	2.470€
------------------	--------	----------	--	---	---	--------

FRY TOP GAS 90 L	GFT99L	90x90x25		16	16	3.390€
------------------	--------	----------	--	----	----	--------

FRY TOP GAS 90 LR	GFT99LR	90x90x25		16	16	3.490€
-------------------	---------	----------	--	----	----	--------

OPCIONAL CROMO 45						515€
-------------------	--	--	--	--	--	------

OPCIONAL CROMO 90						890€
-------------------	--	--	--	--	--	------

Todos los Fry tops incluyen válvula termostática y peto antislipaduras



FREIDORA GAS 20 L	GF49T	45x90x58		16,5	16,5	3.265€
-------------------	-------	----------	--	------	------	--------



CUECEPASTAS 45 GAS	GC49T	45x90x58		13,9	13,9	3.380€
--------------------	-------	----------	--	------	------	--------

CUECEPASTAS 90 GAS	GC99T	90x90x58		13,9x2	27,8	5.445€
--------------------	-------	----------	--	--------	------	--------

Cestos no incluidos en dotación. Cuba en Aisi 316



GRILL PIEDRA VOLC45 GAS	GPL49	45x90x25		11	11	2.450€
-------------------------	-------	----------	--	----	----	--------

GRILL PIEDRA VOLC90 GAS	GPL99	90x90x25		22	22	4.250€
-------------------------	-------	----------	--	----	----	--------



BAÑO MARIA GAS 45	GBM49T	45x90x25		4,5	4,5	2.165€
-------------------	--------	----------	--	-----	-----	--------

BAÑO MARIA GAS 90	GBM99T	90x90x25		7	7	2.695€
-------------------	--------	----------	--	---	---	--------

Cubetas no incluidas en dotación



SARTEN BASCULANTE GAS	GBR9T	113x90x50		21	21	6.980€
-----------------------	-------	-----------	--	----	----	--------

Amplía zona de trabajo

900 SBALZO

C



MÁQUINA	MODELO	DIMENSIONES	POTENCIA KW	T	VOLTAJE	PVP
---------	--------	-------------	-------------	---	---------	-----



HORNO SUSPENDIDO GAS	GFB09	90x90x45	7	7		2.185€
-----------------------------	--------------	----------	---	---	--	---------------

Dimensiones internas del horno 540x720x300. 3GN 1/1.

900 SBALZO ELÉCTRICO



MÁQUINA	MODELO	DIMENSIONES	POTENCIA KW	T	VOLTAJE	PVP
---------	--------	-------------	-------------	---	---------	-----



COCINA 2 PLACAS REDONDAS	E29	45x90x25	2 x 3,5	7	400V 3F+N	1.995€
---------------------------------	------------	----------	---------	---	-----------	---------------

COCINA 4 PLACAS REDONDAS	E49	90x90x25	4 x 3,5	14	400V 3F+N	3.450€
---------------------------------	------------	----------	---------	----	-----------	---------------

COCINA 2 PLACAS CUADRADAS	E29Q	45x90x25	2 x 3	6	400V 3F+N	2.295€
----------------------------------	-------------	----------	-------	---	-----------	---------------

COCINA 4 PLACAS CUADRADAS	E49Q	90x90x25	4 x 3	12	400V 3F+N	3.970€
----------------------------------	-------------	----------	-------	----	-----------	---------------



FRY 45 L ELECTRICO	EFT49L	45x90x25	6	6	400V 3F+N	2.465€
---------------------------	---------------	----------	---	---	-----------	---------------

FRY 45 R ELECTRICO	EFT49R	45x90x25	6	6	400V 3F+N	2.565€
---------------------------	---------------	----------	---	---	-----------	---------------

OPCIONAL CROMO 45						515€
--------------------------	--	--	--	--	--	-------------



FREIDORA 20 LIT ELECTRICA	EF49T	45x90x58	16	16	400V 3F+N	3.295€
----------------------------------	--------------	----------	----	----	-----------	---------------



GUECEPASTAS 45 ELECTTRICO	EC49T	45x90x58	9	9	400V 3F+N	3.490€
----------------------------------	--------------	----------	---	---	-----------	---------------

Cestos no incluidos en dotación. Cuba en Aisi 316



MARMITA INDIRECTA 150 L	E150IT9	90x90x70	15	15	400V 3F+N	7.995€
--------------------------------	----------------	----------	----	----	-----------	---------------

Fondo cuba en Aisi 316

1100 CENTRAL

C



MÁQUINA	MODELO	DIMENSIONES	POTENCIA KW	T	VOLTAJE	PVP
	COCINA 2 FUEGOS Y ARMARIO	11CP02	45x110x90	8 + 6	14	3.440€
	COCINA 4 FUEGOS Y HORNO	11CP24	90x110x90	8x2+6x2+10	40	6.750€
	PALASTRO CON ARMARIO	11GTA	90x110x90	12	12	4.995€
	PALASTRO CON HORNO	11GTF	90x110x90	12+10	22	7.395€
	FRY 90 L	11GFTAL	90x110x90	18	18	5.645€
	FRY 90 L CROMADO	11GFTALC	90x110x90	18	18	6.645€
	FRY 90 LR	11GFTALR	90x110x90	18	18	5.895€
	FRY 90 LR CROMADO	11GFTA11LRC	90x110x90	18	18	5.995€
	FREIDORA 20 L GAS	11GF20	67,5x110x90	15,2	15,2	5.660€
	FREIDORA 20+20 L GAS	11GF202	112,5x110x90	15,2x2	30,4	8.990€



MÁQUINA	MODELO	DIMENSIONES	POTENCIA KW	T	VOLTAJE	PVP	
	FREIDORA 20 L ELECTRICA	11EF20	45x110x90	16	16	400V 3F+N	4.545€
	BAÑO MARIA ELECTRICO	11EB	45x110x90	2,5	2,5	400V 3F+N	3.900€
	<i>Puerta y cubeta no incluido en precio</i>						

NEUTROS

MÁQUINA	MODELO	DIMENSIONES	PVP	
	NEUTRO DE 20	11NA20	22,5x110x90	845€
	NEUTRO DE 40 CON PUERTA	11NA40	45x110x90	2.725€
	NEUTRO DE 90 CON PUERTA	11NA90	90x110x90	3.765€



MÁQUINA	MODELO	DIMENSIONES	POTENCIA KW	T	VOLTAJE	PVP
---------	--------	-------------	-------------	---	---------	-----



PLACA INDUCCIÓN Ø 22	LDIPI1	35x30x7	2,2	2,2	230V F+N	239€
PLACA INDUCCIÓN Ø 16 / Ø 20	LDIPI2	29x51x9	1,3+1,8	3,3	230V F+N	378€

Mantenedor. Timer hasta 99 minutos. Aviso sonoro y auto apagado.



COCINA VITRO 2 P	ODI7CE2V	35x57x10	1,8+2,5	4,3	230V F+N	2.230€
COCINA VITRO 4 P	ODI7CE4V	50x57x10	2x1,8+2x2,5	8,6	230V F+N	3.390€



MANTENEDOR FRITOS	ODISPE40	35x57x30	0,8	0,8	230V F+N	1.160€
MANTENEDOR Bº Mº	ODITBE40	35x57x30	1	1	230V F+N	1.730€



WOK INDUCCIÓN	ODI7CIE0IW	35x57x30	8		400V 3F+N	6.795€
---------------	------------	----------	---	--	-----------	---------------



FRY TOP LISO CROMO	ODI7TFELC	35x57x15	4,8		400V 3F+N	2.360€
--------------------	-----------	----------	-----	--	-----------	---------------



FREIDORA 15 LIT	ODIU7FREIS	35x57x40	12		400V 3F+N	2.115€
-----------------	------------	----------	----	--	-----------	---------------



CUECEPASTAS 2/3	ODIU7CP35	35x57x40	9		400V 3F+N	2.990€
-----------------	-----------	----------	---	--	-----------	---------------

Equipos Drop-In fríos y baño maría en apartado Buffet (Inox)

COCINAS ASIATICAS Y EUROASIATICAS BASIC



MÁQUINA	MODELO	DIMENSIONES	POTENCIA KW	T	PVP
---------	--------	-------------	-------------	---	-----



1 F TOP	CCT01	60x70x28	9,5	9,5	1.600€
2 F TOP	CCT02	100x70x28	9,5+14	23,5	2.675€
3 F TOP	CCT03	150x70x28	9,5+14+23	46,5	3.595€
4 F TOP	CCT04	200x70x28	9,5+2*14+23	60,5	4.690€
5 F TOP	CCT05	250x70x28	9,5+3*14+23	74,5	5.900€



1 F MUEBLE	CC01	60x70x85	9,5	9,5	1.990€
2 F MUEBLE	CC02	100x70x85	9,5+14	23,5	3.160€
3 F MUEBLE	CC03	150x70x85	9,5+14+23	46,5	4.480€
4 F MUEBLE	CC04	200x70x85	9,5+2*14+23	60,5	5.490€
5 F MUEBLE	CC05	250x70x85	9,5+3*14+23	74,5	6.890€

OPCIONALES GAMA BASIC

Canal posterior, central o anterior de desagüe	309€	Columna de agua con mando manual frontal	595€
1 línea de lavado + 1 canal de desagüe	790€	Rebosadero para el canal de desagüe	79€
2 líneas de lavado + 1 canal central de desagüe	990€	Diseños especiales	CONSULTAR

COCINAS ASIATICAS Y EUROASIATICAS ÚNICO 700



MÁQUINA	MODELO	DIMENSIONES	POTENCIA KW	T	PVP
---------	--------	-------------	-------------	---	-----



2 F MUEBLE	DG 702	110x70x90	12+12	24	3.385€
------------	--------	-----------	-------	----	--------

Opcional: Quemador 18 KW: añadir 240€ por quemador. Cubas estampadas con canalización para el agua y desagüe.

3 F MUEBLE	DG 703	165x70x90	12+12+12	36	4.550€
------------	--------	-----------	----------	----	--------

Opcional: Quemador 18 KW: añadir 240€ por quemador cubas estampadas con canalización para el agua y desagüe.

FREGADERO	D7 LA1V	55X70X90			1.290€
-----------	---------	----------	--	--	--------

Dimensiones de la cuba: 40x40

COCINAS ASIATICAS Y EUROASIATICAS ÚNICO 1.100

C



MÁQUINA

MODELO

DIMENSIONES

POTENCIA KW

T

PVP



2 FUEGOS MURAL

DG1 102

55x110x90

12x2

24

3.300€

2 FUEGOS PASANTE

DG1 102 P

55x110x90

12x2

24

3.315€

Opcional: Quemador 18 KW: añadir 240€ por quemador. Cubas estampadas con canalización para el agua y desagüe.



4 FUEGOS MURAL

DG1 104

110x110x90

12x4

48

5.460€

4 FUEGOS PASANTE

DG1 104 P

110x110x90

12x4

48

5.480€

Opcional: Quemador 18 KW: añadir 240€ por quemador. Cubas estampadas con canalización para el agua y desagüe.



6 FUEGOS MURAL

DG1 106

165x110x90

12x6

72

7.515€

6 FUEGOS PASANTE

DG1 106 P

165x110x90

12x6

72

7.525€

Opcional: Quemador 18 KW: añadir 240€ por quemador. Cubas estampadas con canalización para el agua y desagüe.



DIM SUM MURAL

DG1 1VM

55x110x90

10,5

10,5

3.735€

DIM SUM PASANTE

DG1 1VP

55x110x90

10,5

10,5

3.760€

Disponibles estos 2 modelos también en eléctrico. Carga automática del agua (precisa toma eléctrica 230V).



FREGADERO

D11-LA-1V

55x110x90

1.565€

Dimensiones de la cuba: 40x50 cm



HORNILLO 12

FBG 661

60x60x50

12

12

1.330€

HORNILLO 18

FBG 662

60x60x50

18

18

1.695€



Sustitución de 1 quemador chino por europeo 10 KW

39€







Serie 600 EV
600 Series EV
Série 600 EV

Características Characteristics Caractéristiques

<i>Modelo</i> <i>Model</i> <i>Modèle</i>	Medidas exteriores External measures Mesures extérieures (mm)	Quemadores Burners Brûleurs 7,4 Kw 120 mm ø 150 mm ø	8,4 Kw	Horno Oven Four Normal 3,84 Kw	Potencia Power Puissance Kw	Kcal / h	Peso Weight Poids (Kg)	€
S612 	400 x 600 x 260	1	-	-	7,33	6300	42	675 €
T612 	400 x 600 x 850	1	-	-	7,33	6300	57	875 €
S615 	400 x 600 x 260	-	1	-	8,37	7200	42	685 €
T615 	400 x 600 x 850	-	1	-	8,37	7200	57	885 €
S625 	800 x 600 x 260	1	1	-	15,70	13500	49	1.010 €
T625 	800 x 600 x 850	1	1	-	15,70	13500	70	1.210 €
625 	800 x 600 x 850	1	1	1	19,54	16800	85	1.880 €
S631 	1200 x 600 x 260	2	1	-	23,02	19800	63	1.400 €
T631 	1200 x 600 x 850	2	1	-	23,02	19800	101	1.795 €
631 	1200 x 600 x 850	2	1	1	26,86	23100	115	2.345 €

Serie 600 EV
600 Series EV
Série 600 EV

Características Characteristics Caractéristiques

<i>Modelo</i> <i>Model</i> <i>Modèle</i>	Medidas exteriores External measures Mesures extérieures (mm)	Quemadores Burners Brûleurs 3,6 Kw 90 mm ø 6,6 Kw 120 mm ø	Horno Oven Four Normal 3,84 Kw	Potencia Power Puissance Kw Kcal / h	Peso Weight Poids (Kg)	€
S604 	400 x 600 x 260	1 1	-	10,2 8772	42	865 €
T604 	400 x 600 x 850	1 1	-	10,2 8772	57	1.040 €
S614 	800 x 600 x 260	2 2	-	20,4 17544	59	1.235 €
T614 	800 x 600 x 850	2 2	-	20,4 17544	79	1.510 €
614 	800 x 600 x 850	2 2	1	24,24 20844	85	2.220 €
H6 	800 x 600 x 700	- -	1	3,84 3300	43	1.400 €

Serie 600 EV
600 Series EV
Série 600 EV

Vitrocerámica
Pyroceram
Vitrocéramique

Características Characteristics Caractéristiques

Modelo Model Modèle	Medidas exteriores External measures Mesures extérieures (mm)	Placas Plates Plaques 180 Ø mm 220 Ø mm 2 Kw 2,6 Kw	Horno Oven Four 6 Kw	Potencia Power Puissance Kw	Peso Weight Poids (Kg)	€
--	---	--	--------------------------------------	---	--	----------

Cocinas y encimeras eléctricas Electric cookers and tops Fourneaux et plans de cuisson électriques

S602E 	400 x 600 x 260	1	1	-	4,6	400 V III + T	42	1.320 €
--	-----------------	---	---	---	-----	---------------	----	----------------

T602E 	400 x 600 x 850	1	1	-	4,6	400 V III + T	57	1.520 €
--	-----------------	---	---	---	-----	---------------	----	----------------

S614E 	800 x 600 x 260	3	1	-	8,6	400 V III + T	59	1.815 €
--	-----------------	---	---	---	-----	---------------	----	----------------

T614E 	800 x 600 x 850	3	1	-	8,6	400 V III + T	79	2.210 €
---	-----------------	---	---	---	-----	---------------	----	----------------

614E 	800 x 600 x 850	3	1	1	14,6	400 V III + T	85	2.860 €
---	-----------------	---	---	---	------	---------------	----	----------------

614EC 	645 x 600 x 850	3	1	1	14,6	400 V III + T	78	2.860 €
--	-----------------	---	---	---	------	---------------	----	----------------

H6E 	800 x 600 x 700	-	-	1	6	400 V III + T	43	1.430 €
--	-----------------	---	---	---	---	---------------	----	----------------

Características Characteristics Caractéristiques

Medidas exteriores External measures Mesures extérieures (mm)	Placas Plates Plaques 330 x 365 mm	Horno Oven Four 6 Kw	Potencia Power Puissance Kw	Peso Weight Poids (Kg)
---	--	--------------------------------------	---	--

Vitrocerámica Pyroceram Vitrocéramique

S60V 	400 x 600 x 260	1	-	2,1	220 V II + T	45	1.360 €
---	-----------------	---	---	-----	--------------	----	----------------

T60V 	400 x 600 x 850	1	-	2,1	220 V II + T	57	1.565 €
---	-----------------	---	---	-----	--------------	----	----------------

Serie 600 EV
600 Series EV
Série 600 EV

Wok / Contenedores
Wok burner / Containers
Feu Wok / Conteneurs

Características Characteristics Caractéristiques

Modelo Model Modèle	Medidas exteriores External measures Mesures extérieures (mm)	Dim. interiores Inter. measures Dim. Intérieures (mm)	Voltaje Voltage Tension V	Potencia Power Puissance Kw	Kcal / h	Peso Weight Poids (Kg)	€
---------------------------	--	--	------------------------------------	--------------------------------------	----------	---------------------------------	---

Baño María Eléctrico Electric Bain-Marie Bain-Marie Électrique

SBME60



400 x 600 x 260	305 x 510 x 120 GN 1/1	220 V II + T	2,5	-	45	710 €
-----------------	---------------------------	--------------	-----	---	----	--------------

BME60



400 x 600 x 850	305 x 510 x 120 GN 1/1	220 V II + T	2,5	-	57	915 €
-----------------	---------------------------	--------------	-----	---	----	--------------

Características Characteristics Caractéristiques

Medidas exteriores External measures Mesures extérieures (mm)	Quemadores Burners Brûleurs 8,4 Kw 150 mm ø	11,56 Kw 160 mm	Horno Oven Four Normal 5,35 Kw	Potencia Power Puissance Kw	Kcal / h	Peso Weight Poids (Kg)
--	---	--------------------	--	--------------------------------------	----------	---------------------------------

Wok Wok burner Feu Wok

S615W



400 x 600 x 260	1	-	-	8,4	7200	57	780 €
-----------------	---	---	---	-----	------	----	--------------

T615W

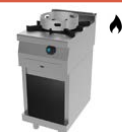

400 x 600 x 850	1	-	-	8,4	7200	69	990 €
-----------------	---	---	---	-----	------	----	--------------

Características Characteristics Caractéristiques

Medidas exteriores External measures Mesures extérieures (mm)	Características Characteristics Caractéristiques	Infraro- jos Infrared Infrarou- ge	Potencia Power Puissance Kw	Peso Weight Poids (Kg)
--	--	--	--------------------------------------	---------------------------------

Contenedores Containers Conteneurs

SC60



400 x 600 x 260	GN 2/3 x 200 mm	-	-	-	16	530 €
-----------------	-----------------	---	---	---	----	--------------

C60



400 x 600 x 850	GN 2/3 x 200 mm	-	-	-	28	735 €
-----------------	-----------------	---	---	---	----	--------------

SCI60



400 x 600 x 620	GN 2/3 x 200 mm	1	2 x 0,4	220 V II + T	18	760 €
-----------------	-----------------	---	---------	--------------	----	--------------

CI60



400 x 600 x 1210	GN 2/3 x 200 mm	1	2 x 0,4	220 V II + T	30	965 €
------------------	-----------------	---	---------	--------------	----	--------------

Serie 750 EV
750 Series EV
Série 750 EV

Características Characteristics Caractéristiques

Modelo <i>Model</i> <i>Modèle</i>	Medidas exteriores External measures Mesures extérieures (mm)	Quemadores Burners Brûleurs 7,4 Kw 120 mm ø 150 mm ø		Horno Oven Four Normal 5,35 Kw	Potencia Power Puissance Kw	Peso Weight Poids (Kg)	€	
S721 	400 x 750 x 380	2	-	-	14,65	12600	65	1.400 €
T721 	400 x 750 x 850	2	-	-	14,65	12600	72	1.595 €
S741 	800 x 750 x 380	4	-	-	29,30	25200	69	2.150 €
T741 	800 x 750 x 850	4	-	-	29,30	25200	89	2.425 €
741 	800 x 750 x 850	4	-	1	34,30	29500	104	3.295 €
S761 	1200 x 750 x 380	6	-	-	43,95	37800	97	2.825 €
T761 	1200 x 750 x 850	6	-	-	43,95	37800	122	3.045 €
761 	1200 x 750 x 850	6	-	1	48,95	42100	140	4.185 €
	Armario caliente guías y parrilla GN Hot cupboard Guides and Grill GN Armoire chauffante Guides et grille GN							480 €
H7 	800 x 750 x 700	-	-	1	5	4300	53	1.515 €









Serie 750 EV
750 Series EV
Série 750 EV

Características Characteristics Caractéristiques

<i>Modelo</i> <i>Model</i> <i>Modèle</i>	Medidas exteriores External measures Mesures extérieures (mm)	Quemadores Burners Brûleurs 7,4 Kw 120 mm ø 150 mm ø	Horno Oven Four Normal 5,35 Kw	Potencia Power Puissance Kw	Peso Weight Poids (Kg)	€	
S721 CHEF 	400 x 750 x 380	2	-	14,65	12600	65	1.795 €
T721 CHEF 	400 x 750 x 850	2	-	14,65	12600	72	1.995 €
S741 CHEF 	800 x 750 x 380	4	-	29,30	25200	69	2.820 €
T741 CHEF 	800 x 750 x 850	4	-	29,30	25200	89	3.095 €
741 CHEF 	800 x 750 x 850	4	1	34,30	29500	104	3.960 €
S761 CHEF 	1200 x 750 x 380	6	-	43,95	37800	97	3.920 €
T761 CHEF 	1200 x 750 x 850	6	-	43,95	37800	122	4.150 €
761 CHEF 	1200 x 750 x 850	6	1	48,95	42100	140	5.280 €
Armario caliente guías y parrilla GN Hot cupboard Guides and Grill GN Armoire chauffante Guides et grille GN						480 €	

Serie 750 EV
750 Series EV
Série 750 EV

Características Characteristics Caractéristiques

Modelo Model Modèle	Medidas exteriores External measures Mesures extérieures (mm)	Quemadores Burners Brûleurs		Horno Oven Four		Potencia Power Puissance		Peso Weight Poids (Kg)	€
		3,6 Kw 90 mm ø	6,6 Kw 120 mm ø	Normal 5,35 Kw	Gran Chef 9,3 Kw	Kw	Kcal / h		
S702 	400 x 750 x 380	1	1	-	-	10,2	8772	65	1.205 €
T702 	400 x 750 x 850	1	1	-	-	10,2	8772	72	1.400 €
S704 	800 x 750 x 380	2	2	-	-	20,4	17544	69	1.815 €
T704 	800 x 750 x 850	2	2	-	-	20,4	17544	89	2.095 €
714 	800 x 750 x 850	2	2	1	-	25,4	21844	104	2.965 €
S706 	1200 x 750 x 380	3	3	-	-	30,6	26316	97	2.205 €
T706 	1200 x 750 x 850	3	3	-	-	30,6	26316	122	2.475 €
716 	1200 x 750 x 850	3	3	1	-	35,6	30616	140	3.315 €
	Armario caliente guías y parrilla GN Hot cupboard Guides and Grill GN Armoire chauffante Guides et grille GN								480 €

Serie 750 EV
750 Series EV
Série 750 EV

Vitrocerámica
Pyroceram
Vitrocéramique

Características Characteristics Caractéristiques

Modelo Model Modèle	Medidas exteriores External measures Mesures extérieures (mm)	Placas Plates Plaques ø 180 mm ø 220 mm 2 Kw 2,6 Kw	Horno Oven Four 6 Kw	Potencia Power Puissance Kw	Peso Weight Poids (Kg)	€
---------------------------	--	---	-------------------------------	--------------------------------------	---------------------------------	---

Cocinas y encimeras eléctricas Electric cookers and tops Fourneaux et plans de cuisson électriques

S721E		400 x 750 x 380	1	1	-	4,6	400 V III + T	65	1.675 €
--------------	---	-----------------	---	---	---	-----	---------------	----	----------------

Placas cuadradas Square plates Plaques carré



1.850 €

T721E		400 x 750 x 850	1	1	-	4,6	400 V III + T	72	1.875 €
--------------	---	-----------------	---	---	---	-----	---------------	----	----------------

Placas cuadradas Square plates Plaques carré



2.050 €

S741E		800 x 750 x 380	2	2	-	9,2	400 V III + T	69	2.260 €
--------------	---	-----------------	---	---	---	-----	---------------	----	----------------

Placas cuadradas Square plates Plaques carré



2.650 €

T741E		800 x 750 x 850	2	2	-	9,2	400 V III + T	89	2.530 €
--------------	---	-----------------	---	---	---	-----	---------------	----	----------------

Placas cuadradas Square plates Plaques carré



2.920 €

741E		800 x 750 x 850	2	2	1	15,2	400 V III + T	104	3.400 €
-------------	---	-----------------	---	---	---	------	---------------	-----	----------------

Placas cuadradas Square plates Plaques carré



3.790 €

H7E		800 x 750 x 700	-	-	1	6	400 V III + T	53	1.485 €
------------	---	-----------------	---	---	---	---	---------------	----	----------------

Características Characteristics Caractéristiques

Medidas exteriores External measures Mesures extérieures (mm)	Placas Plates Plaques 540 x 320 mm 2 x 2,1 Kw	Horno Oven Four 6 Kw	Potencia Power Puissance Kw	Peso Weight Poids (Kg)
--	---	-------------------------------	--------------------------------------	---------------------------------

Vitrocerámica Pyroceram Vitrocéramique

S70V		400 x 750 x 380	1	-	4,2	400 V III + T	45	2.100 €
-------------	---	-----------------	---	---	-----	---------------	----	----------------

T70V		400 x 750 x 850	1	-	4,2	400 V III + T	57	2.315 €
-------------	---	-----------------	---	---	-----	---------------	----	----------------

Serie 750 EV
750 Series EV
Série 750 EV

Contenedores
Containers
Conteneurs

Características Characteristics Caractéristiques

Modelo Model Modèle	Medidas exteriores External measures Mesures extérieures (mm)	Quemadores Burners Brûleurs 8,4 Kw 150 mm ø	Horno Oven Four Normal 5,35 Kw	Potencia Power Puissance Kw	Peso Weight Poids (Kg)	€
--	---	--	---	---	--	----------

Wok / Paellero Wok burner / Paella cooker Feu Wok / Feu pour Paella

S715W Wok Wok Wok		400 x 750 x 380	1	-	-	8,37	7200	63	885 €
-----------------------------	---	-----------------	---	---	---	------	------	----	--------------

T715W Wok Wok Wok		400 x 750 x 850	1	-	-	8,37	7200	70	1.090 €
-----------------------------	---	-----------------	---	---	---	------	------	----	----------------

P70		800 x 750 x 850	-	1	-	11,56	9944	89	2.165 €
------------	---	-----------------	---	---	---	-------	------	----	----------------

P71		800 x 750 x 850	-	1	1	16,21	13994	104	3.070 €
------------	--	-----------------	---	---	---	-------	-------	-----	----------------

Características Characteristics Caractéristiques

Medidas exteriores External measures Mesures extérieures (mm)	Características Characteristics Caractéristiques	Infraro- jos Infrared Infrarou- ge	Potencia Power Puissance Kw	Peso Weight Poids (Kg)
---	---	--	---	--

Contenedores Containers Conteneurs

C70		400 x 750 x 850	G.N. 1/1	-	-	-	30	845 €
------------	---	-----------------	----------	---	---	---	----	--------------

SC70 Sobremesa Countertop A poser













CI70		400 x 750 x 1220	G.N. 1/1	1	2 x 0,6	220 V II + T	36	1.070 €
-------------	---	------------------	----------	---	---------	--------------	----	----------------

SCI70 Sobremesa Countertop A poser

Serie 900 EV
900 Series EV
Série 900 EV

Cocinas con cámara de agua CHEF
Cookers with water chamber CHEF
Fourneaux sur bac à eau CHEF

Características Characteristics Caractéristiques

Modelo Model Modèle	Medidas exteriores External measures Mesures extérieures (mm)	Quemadores Burners Brûleurs 7,4 Kw 120 mm ø 150 mm ø	8,4 Kw	Horno Oven Four Normal 5,35 Kw	Gran Chef 9,3 Kw	Potencia Power Puissance Kw	Kcal / h	Peso Weight Poids (Kg)	€
T201 	400 x 900 x 850	1	1	-	-	15,70	13500	93	1.695 €
ST201	Sobremesa Countertop A posar								
T401 	800 x 900 x 850	3	1	-	-	30,35	26100	104	2.660 €
ST401	Sobremesa Countertop A posar								
411 	800 x 900 x 850	3	1	1	-	35,70	30700	174	3.790 €
T601 	1200 x 900 x 850	4	2	-	-	46,05	39600	130	3.535 €
ST601	Sobremesa Countertop A posar								
611 	1200 x 900 x 850	4	2	1	-	51,40	44200	194	4.915 €
	Armario caliente guías y parrilla GN Hot cupboard guides and grill GN Armoire chauffante guides et grille GN								
									480 €
611HG 	1200 x 900 x 850	4	2	-	1	55,35	47600	194	6.445 €
T201 CHEF 	400 x 900 x 850	1	1	-	-	15,70	13500	93	2.090 €
ST201 CHEF	Sobremesa Countertop A posar								
T401 CHEF 	800 x 900 x 850	3	1	-	-	30,35	26100	104	3.330 €
ST401 CHEF	Sobremesa Countertop A posar								
411 CHEF 	800 x 900 x 850	3	1	1	-	35,70	30700	174	4.450 €
T601 CHEF 	1200 x 900 x 850	4	2	-	-	46,05	39600	130	4.620 €
ST601 CHEF	Sobremesa Countertop A posar								
611 CHEF 	1200 x 900 x 850	4	2	1	-	51,40	44200	194	6.005 €
	Armario caliente guías y parrilla GN Hot cupboard guides and grill GN Armoire chauffante guides et grille GN								
									480 €
611HG CHEF 	1200 x 900 x 850	4	2	-	1	55,35	47600	194	7.535 €

Serie 900 EV
900 Series EV
Série 900 EV

Vitrocerámica e Inducción
Pyroceram and Induction
Vitrocéramique et Induction

Características Characteristics Caractéristiques

Modelo Model Modèle	Medidas exteriores External measures Mesures extérieures (mm)	Placas Plates Plaques 300 x 300 mm 3 Kw 4 Kw	Horno Oven Four 6 Kw	Potencia Power Puissance Kw	Peso Weight Poids (Kg)	€
---------------------------	--	--	-------------------------------	--------------------------------------	---------------------------------	---

Cocinas y encimeras eléctricas Electric cookers and tops Fourneaux et plans de cuisson électriques

TE201		400 x 900 x 850	1	1	-	7	400 V III + T	93	2.120 €
STE201		⚡ Sobremesa Countertop A posar							
TE401		800 x 900 x 850	2	2	-	14	400 V III + T	104	3.340 €
STE401		⚡ Sobremesa Countertop A posar							
E411		800 x 900 x 850	2	2	1	20	400 V III + N + T	174	4.865 €

Características Characteristics Caractéristiques

Medidas exteriores External measures Mesures extérieures (mm)	Placas Plates Plaques 720 x 350 mm 2 x 3,5 Kw	Horno Oven Four 6 Kw	Potencia Power Puissance Kw	Peso Weight Poids (Kg)
--	---	-------------------------------	--------------------------------------	---------------------------------

Vitrocerámica Pyroceram Vitrocéramique

T90V		400 x 900 x 850	1	-	7	400 V III + T	65	2.710 €	
ST90V		⚡ Sobremesa Countertop A posar							

Características Characteristics Caractéristiques

Medidas exteriores External measures Mesures extérieures (mm)	Placas Plates Plaques 300 mm ø 580 x 320 mm	Horno Oven Four 6 Kw	Potencia Power Puissance Kw	Peso Weight Poids (Kg)
--	--	-------------------------------	--------------------------------------	---------------------------------

Inducción Induction Induction

T90 IN		400 x 900 x 850	-	1	-	2 x 3,5	400 V III + T	65	6.960 €
ST90 IN		⚡ Sobremesa Countertop A posar							
T90 IN GP		400 x 900 x 850	-	1	-	2 x 5	400 V III + T	65	7.175 €
ST90 IN GP		⚡ Sobremesa Countertop A posar							
T90 W IN		400 x 900 x 850	1	-	-	3,5	400 V III + T	53	4.540 €
ST90 W IN		⚡ Sobremesa Countertop A posar							
T90 W IN GP		400 x 900 x 850	1	-	-	5	400 V III + T	53	4.645 €
ST90 W IN GP		⚡ Sobremesa Countertop A posar							

Serie 900 EV
900 Series EV
Série 900 EV

Hornos de cocción
Ovens
Fours de cuisson

Características Characteristics Caractéristiques

Modelo Model Modèle	Medidas exteriores External measures Mesures extérieures (mm)	Quemadores Burners Brûleurs 7,4 Kw 8,4 Kw 11,56 Kw 120 mm ø 150 mm ø	Horno Oven Four Normal 5,35 Kw	Potencia Power Puissance Kw Kcal / h	Peso Weight Poids (Kg)	€
---------------------------	--	--	--	---	---------------------------------	---

Hornillo Gran Rendimiento / Wok / Paellero High-Performance Stove / Wok burner / Paella cooker Petit Four à Hout Rendement / Feu Wok / Feu pour Paella

160HGR		730 x 730 x 500	-	-	ø 160 mm	-	11,56	9944	47	1.215 €
---------------	---	-----------------	---	---	----------	---	-------	------	----	----------------

T915W Wok Wok Wok		400 x 900 x 850	1	1	-	-	15,70	13500	90	1.205 €
-----------------------------	---	-----------------	---	---	---	---	-------	-------	----	----------------

ST915W		Sobremesa Countertop A posar								
---------------	---	------------------------------	--	--	--	--	--	--	--	--

P90		800 x 900 x 850	-	-	ø 230 mm	-	11,63	10000	120	3.590 €
------------	---	-----------------	---	---	----------	---	-------	-------	-----	----------------

P91		800 x 900 x 850	-	-	ø 230 mm	1	16,83	14474	190	4.725 €
------------	--	-----------------	---	---	----------	---	-------	-------	-----	----------------

Características Characteristics Caractéristiques

Medidas exteriores External measures Mesures extérieures (mm)	Dim. interiores Inter. measures Dim. Intérieures (mm)	Voltaje Voltage Tension V	Potencia Power Puissance Kw Kcal / h	Peso Weight Poids (Kg)
--	--	------------------------------------	---	---------------------------------

Hornos de cocción Ovens Fours de cuisson

H9		800 x 900 x 700	530 x 750 x 330	-	4,4	4600	83	1.775 €
-----------	---	-----------------	-----------------	---	-----	------	----	----------------

HE9		800 x 900 x 700	530 x 750 x 330	400 V III + N + T	6	-	83	1.775 €
------------	---	-----------------	-----------------	-------------------	---	---	----	----------------

H9HG		1200 x 900 x 700	735 x 750 x 330	-	9,5	8000	95	3.555 €
-------------	---	------------------	-----------------	---	-----	------	----	----------------

S9		800 x 900 x 600	-	-	-	-	12	480 €
-----------	---	-----------------	---	---	---	---	----	--------------

Serie 1000 EV
1000 Series EV
Série 1000 EV

Cocinas con cámara de agua CHEF
Cookers with water chamber CHEF
Fourneaux sur bac à eau CHEF

Características Characteristics Caractéristiques

Modelo Model Modèle	Medidas exteriores External measures Mesures extérieures (mm)	Quemadores Burners Brûleurs 7,4 Kw 120 mm ø 150 mm ø	Horno Oven Four GN 5,35 Kw	Potencia Power Puissance Kw	Peso Weight Poids (Kg)	€		
T20C 	450 x 1000 x 850	1	1	-	15,70	13500	93	2.565 €
ST20C	Sobremesa Countertop A posar							
T40C 	900 x 1000 x 850	3	1	-	30,35	26100	104	4.275 €
ST40C	Sobremesa Countertop A posar							
40P 	900 x 1000 x 850	3	1	1	35,70	30700	174	5.300 €
T60C 	1300 x 1000 x 850	4	2	-	46,05	39600	130	5.125 €
ST60C	Sobremesa Countertop A posar							
60P 	1300 x 1000 x 850	4	2	1	51,40	44200	194	6.315 €
	Armario caliente guías y parrilla GN Hot cupboard Guides and Grill GN Armoire chauffante Guides et grille GN							480 €
T20C CHEF 	450 x 1000 x 850	1	1	-	15,70	13500	194	2.965 €
ST20C CHEF	Sobremesa Countertop A posar							
T40C CHEF 	900 x 1000 x 850	3	1	-	30,35	26100	93	4.940 €
ST40C CHEF	Sobremesa Countertop A posar							
40P CHEF 	900 x 1000 x 850	3	1	1	35,70	30700	104	5.965 €
T60C CHEF 	1300 x 1000 x 850	4	2	-	46,05	39600	174	6.210 €
ST60C CHEF	Sobremesa Countertop A posar							
60P CHEF 	1300 x 1000 x 850	4	2	1	51,40	44200	130	7.400 €
	Armario caliente guías y parrilla GN Hot cupboard Guides and Grill GN Armoire chauffante Guides et grille GN							480 €

Serie 1000 EV
1000 Series EV
Série 1000 EV

Vitrocerámica e Inducción
Pyroceram and Induction
Vitrocéramique et Induction

Características Characteristics Caractéristiques

Modelo Model Modèle	Medidas exteriores External measures Mesures extérieures (mm)	Placas Plates Plaques 300 x 300 mm 3 Kw	Placas Plates Plaques 300 x 300 mm 4 Kw	Horno Oven Four 6 Kw	Potencia Power Puissance Kw	Peso Weight Poids (Kg)	€
---------------------------	--	---	---	-------------------------------	--------------------------------------	---------------------------------	---

Cocinas y encimeras eléctricas Electric cookers and tops Fourneaux et plans de cuisson électriques

TE 20C		450 x 1000 x 850	1	1	-	7	400 V III + T	93	3.100 €
---------------	---	------------------	---	---	---	---	---------------	----	----------------

STE 20C		⚡ Sobremesa Countertop A poser							
----------------	---	--------------------------------	--	--	--	--	--	--	--

TE 40C		900 x 1000 x 850	2	2	-	14	400 V III + T	104	5.350 €
---------------	---	------------------	---	---	---	----	---------------	-----	----------------

STE 40C		⚡ Sobremesa Countertop A poser							
----------------	---	--------------------------------	--	--	--	--	--	--	--

40 PE		900 x 1000 x 850	2	2	1	20	400 V III + N + T	174	6.375 €
--------------	---	------------------	---	---	---	----	-------------------	-----	----------------

Características Characteristics Caractéristiques

Medidas exteriores External measures Mesures extérieures (mm)	Placas Plates Plaques 720 x 350 mm 2 x 3,5 Kw	Horno Oven Four 6 Kw	Potencia Power Puissance Kw	Peso Weight Poids (Kg)
--	---	-------------------------------	--------------------------------------	---------------------------------

Vitrocerámica Pyroceram Vitrocéramique

T50V		450 x 1000 x 850	1	-	7	400 V III + T	65	3.155 €
-------------	---	------------------	---	---	---	---------------	----	----------------

ST50V		⚡ Sobremesa Countertop A poser							
--------------	---	--------------------------------	--	--	--	--	--	--	--

Características Characteristics Caractéristiques

Medidas exteriores External measures Mesures extérieures (mm)	Placas Plates Plaques 300 mm ø	Placas Plates Plaques 580 x 320 mm	Horno Oven Four 6 Kw	Potencia Power Puissance Kw	Peso Weight Poids (Kg)
--	--	---	-------------------------------	--------------------------------------	---------------------------------

Inducción Induction Induction

T50 IN		450 x 1000 x 850	-	1	-	2 x 3,5	400 V III + T	65	7.405 €
---------------	---	------------------	---	---	---	---------	---------------	----	----------------

ST50 IN		⚡ Sobremesa Countertop A poser							
----------------	---	--------------------------------	--	--	--	--	--	--	--

T50 IN GP		450 x 1000 x 850	-	1	-	2 x 5	400 V III + T	65	7.620 €
------------------	---	------------------	---	---	---	-------	---------------	----	----------------

ST50 IN GP		⚡ Sobremesa Countertop A poser							
-------------------	---	--------------------------------	--	--	--	--	--	--	--

T50 W IN Wok Wok Wok		450 x 1000 x 850	1	-	-	2 x 3,5	400 V III + T	53	4.985 €
--------------------------------	---	------------------	---	---	---	---------	---------------	----	----------------

ST50 W IN		⚡ Sobremesa Countertop A poser							
------------------	---	--------------------------------	--	--	--	--	--	--	--

T50 W IN GP Wok Wok Wok		450 x 1000 x 850	1	-	-	2 x 5	400 V III + T	53	5.095 €
-----------------------------------	---	------------------	---	---	---	-------	---------------	----	----------------

ST50 W IN GP		⚡ Sobremesa Countertop A poser							
---------------------	---	--------------------------------	--	--	--	--	--	--	--

Serie 1000 EV
1000 Series EV
Série 1000 EV

Muebles neutros
Neutral Cupboards
Meubles Neutres

Características Characteristics Caractéristiques

<i>Modelo</i> <i>Model</i> <i>Modèle</i>	Medidas exteriores External measures Mesures extérieures (mm)	Quemadores Burners Brûleurs 8,37 Kw 150 mm ø	Horno Oven Four	Potencia Power Puissance Kw Kcal / h	Peso Weight Poids (Kg)	€
--	--	--	-----------------------	--	---------------------------------	---

Wok Wok burner Feu Wok
T50W



450 x 1000 x 850	2	-	16,74	14400	90	2.780 €
------------------	---	---	-------	-------	----	----------------

ST50W

☿ Sobremesa Countertop Bureau

Características Characteristics Caractéristiques

Medidas exteriores External measures Mesures extérieures (mm)	Cajón G.N. 1/1 Drawer G.N. 1/1 Tiroir G.N. 1/1 (mm)	Potencia Power Puissance	Peso Weight Poids (Kg)
--	--	--------------------------------	---------------------------------

Muebles neutros Neutral Cupboards Muebles Neutres

MN50



450 x 1000 x 850	-	-	-	-	75	1.160 €
------------------	---	---	---	---	----	----------------

SMN50

☿ Sobremesa Countertop A poser

MN51



900 x 1000 x 850	1	-	-	-	85	1.380 €
------------------	---	---	---	---	----	----------------

SMN51

☿ Sobremesa Countertop A poser

MN100



450 x 1000 x 850	-	-	-	-	125	1.485 €
------------------	---	---	---	---	-----	----------------

SMN100

☿ Sobremesa Countertop A poser

MN101



900 x 1000 x 850	2	-	-	-	145	1.910 €
------------------	---	---	---	---	-----	----------------

SMN101

☿ Sobremesa Countertop A poser

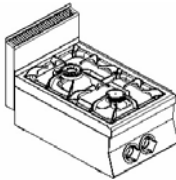
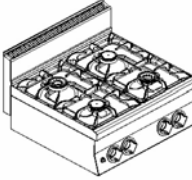
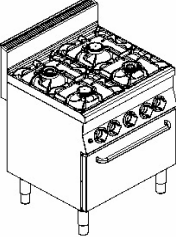
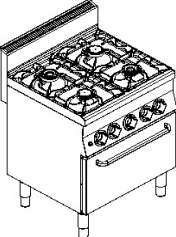

MODULOS DE COCCION A GAS

	MODELO	DESCRIPCIÓN	CM.AxPxH	KGS.	CÓDIGO	EUROS
			KW	M3		
	C64G	Top 2 fuegos 1 Quemador de 3,5 Kw 1 Quemador de 6 Kw	40x65x29,5 9,5	0,14	CR0852960	906,00 €
	C64GP	Top 2 fuegos potenciados 2 Quemadores de 6 Kw	40x65x29,5 12	0,14	CR0852950	927,00 €
	C67G	Top 4 fuegos 2 Quemadores de 3,5 Kw 2 Quemadores de 6 Kw	70x65x29,5 19	0,24	CR0852970	1.400,00 €
	C67GP	Top 4 fuegos potenciados 4 Quemadores de 6 Kw	70x65x29,5 24	0,23	CR0855650	1.429,00 €
	C6FG7G	Cocina 4 fuegos con horno gas 2 Quemadores de 3,5 Kw 2 Quemadores de 6 Kw Dimensiones de la cámara de cocción del horno 57x53x29,5 cm. 1 Quemador de 5 Kw.	70x65x87 24	0,7	CR0852990	2.641,00 €
	C6FG7GP	Cocina 4 fuegos potenciados con horno gas 4 Quemadores de 6 Kw Dimensiones de la cámara de cocción del horno 57x53x29,5 cm. 1 Quemador de 5 Kw.	70x65x87 29	0,5	CR0854750	2.671,00 €
	C6FES7G	Cocina mixta 4 fuegos con horno electrico estático 2 Quemadores de 3,5 Kw 2 Quemadores de 6 Kw Dimensiones de la cámara de cocción del horno 57x53x29,5 cm. Potencia horno 4,2 Kw. Tensión: VAC230-3 50/60 Hz VAC400-3N 50/60 Hz	70x65x87 19g 4,2e	0,7	CR0853000	2.658,00 €
	C6FES7GP	Cocina mixta 4 fuegos potenciados con horno electrico estático 4 Quemadores de 6 Kw Dimensiones de la cámara de cocción del horno 57x53x29,5 cm. Potencia horno 4,2 Kw. Tensión: VAC230-3 50/60 Hz VAC400-3N 50/60 Hz	70x65x87 24g 4,2	0,4	CR0853850	2.697,00 €

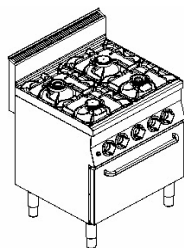
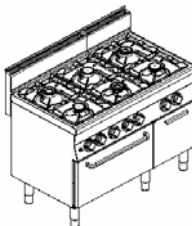

MODULOS DE COCCION A GAS

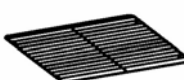
	MODELO	DESCRIPCIÓN	CM.AxPxH	KGS.	CÓDIGO	EUROS
			KW	M3		
	C6FEV7G	Cocina mixta 4 fuegos con horno eléctrico ventilado 2 Quemadores de 3,5 Kw 2 Quemadores de 6 Kw Dimensiones de la cámara de cocción del horno 57x53x29,5 cm. Potencia horno 4,2 Kw. Tensión: VAC230-3 50/60 Hz VAC400-3N 50/60 Hz	70x65x87 19g 4,2e	0,7	CR0853010	3.150,00 €
	C6FEV7GP	Cocina mixta 4 fuegos potenciados con horno eléctrico ventilado 4 Quemadores de 6 Kw Dimensiones de la cámara de cocción del horno 57x53x29,5 cm. Potencia horno 4,2 Kw. Tensión: VAC230-3 50/60 Hz VAC400-3N 50/60 Hz	70x65x87 24g 4,2	0,4	CR0852980	3.179,00 €
	C6FG11G	Cocina 6 fuegos con horno gas y armario neutro 3 Quemador de 3,5 Kw 3 Quemador de 6 Kw Dimensiones de la cámara de cocción del horno 57x53x29,5 cm. 1 Quemador de 5 Kw.	110x65x87 33,5	1,09	CR0853020	3.707,00 €

ACCESORIOS

	C70XGRFVS	Rejilla en acero cromado para horno estático y ventilado	53x47x1,2	0,01	CR0858140	32,00 €
	C70XTFVS	Bandeja para horno en acero inox AISI 304	53x47x3,7	0,02	CR0858150	114,00 €

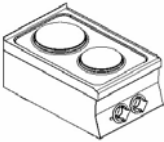
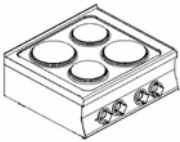
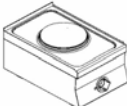
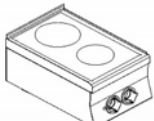
MÓDULOS DE COCCIÓN ELÉCTRICOS

	MODELO	DESCRIPCIÓN	CM.AxPxH	KGS.	CÓDIGO	EUROS
			KW	M3		
	C64E	Top 2 placas redondas 1 de 1,5 Kw diam. 18 cm. 1 de 2,6 Kw diam. 22 cm. 400 V 3N 50-60 Hz 230 V 3 50-60 Hz 230 V 50-60 Hz	40x60x29,5 4,1	0,13	CR0853030	815,00 €
	C64EP	Top 2 placas redondas 2 de 2,6 Kw diam. 22 cm. 400 V 3N 50-60 Hz 230 V 3 50-60 Hz 230 V 50-60 Hz	40x60x29,5 5,2	0,13	CR0853040	900,00 €
	C67E	Top 4 placas redondas 2 de 1,5 Kw diam. 18 cm. 2 de 2,6 Kw diam. 22 cm. 400 V 3N 50-60 Hz 230 V 3 50-60 Hz 230 V 50-60 Hz	70x60x29,5 8,2	0,22	CR0853050	1.188,00 €
	C67EP	Top 4 placas redondas 4 de 2,6 Kw diam. 22 cm. 400 V 3N 50-60 Hz 230 V 3 50-60 Hz	70x60x29,5 10,4	0,22	CR0853060	1.357,00 €
	C64EM	Top 1 placa redonda 1 de 3,5 Kw diam. 33 cm. 230 V 50-60 Hz	40x60x29,5 3,5	0,13	CR0858180	881,00 €
	V64E	Top vitroceramica 2 zonas 1 de 1,8 Kw diam. 18 cm. 1 de 2,5 Kw diam. 22 cm. 400 V 3N 50-60 Hz 230 V 3 50-60 Hz 230 V 50-60 Hz	40x60x29,5 4,3	0,13	CR0853110	1.681,00 €
	V64EP	Top vitroceramica 2 zonas 2 de 2,5 Kw diam. 22 cm. 400 V 3N 50-60 Hz 230 V 3 50-60 Hz 230 V 50-60 Hz	40x60x29,5 5	0,13	CR0853120	1.765,00 €
	V67E	Top vitroceramica 4 zonas 1 de 1,2 Kw diam. 14,5 cm. 1 de 1,8 Kw diam. 18 cm. 2 de 2,5 Kw diam. 22 cm. 400 V 3N 50-60 Hz 230 V 3 50-60 Hz 230 V 50-60 Hz	70x60x29,5 8	0,22	CR0853130	2.165,00 €
	V67EP	Top vitroceramica 4 zonas 4 de 2,5 Kw diam. 22 cm. 400 V 3N 50-60 Hz 230 V 3 50-60 Hz	70x60x29,5 10	0,22	CR0853140	2.269,00 €

COCINAS ELECTRICAS

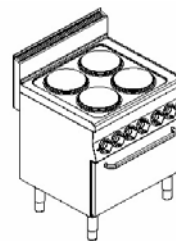
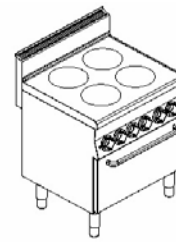
	MODELO	DESCRIPCIÓN	CM.AxPxH	KGS.	CÓDIGO	EUROS
			KW	M3		
	C6FEV7E	Cocina 4 placas con horno ventilado 2 de 1,5 Kw diam. 18 cm. 2 de 2,6 Kw diam. 22 cm. Potencia horno 4,2 Kw. Dimensiones de la cámara de cocción del horno 57x53x29,5 cm. 400 V 3N 50-60 Hz 230 V 3 50-60 Hz	70x65x87 12,4	0,7	CR0853090	2.951,00 €
	C6FEV7EP	Cocina 4 placas con horno ventilado 4 de 2,6 Kw diam. 22 cm. Potencia horno 4,2 Kw. Dimensiones de la cámara de cocción del horno 57x53x29,5 cm. 400 V 3N 50-60 Hz 230 V 3 50-60 Hz	70x65x87 14,6	0,7	CR0853100	3.041,00 €
	C6FES7E	Cocina 4 placas con horno estático 2 de 1,5 Kw diam. 18 cm. 2 de 2,6 Kw diam. 22 cm. Potencia horno 4,2 Kw. Dimensiones de la cámara de cocción del horno 57x53x29,5 cm. 400 V 3N 50-60 Hz 230 V 3 50-60 Hz	70x65x87 12,4	0,7	CR0853070	2.745,00 €
	C6FES7EP	Cocina 4 placas con horno estático 4 de 2,6 Kw diam. 22 cm. Potencia horno 4,2 Kw. Dimensiones de la cámara de cocción del horno 57x53x29,5 cm. 400 V 3N 50-60 Hz 230 V 3 50-60 Hz	70x65x87 14,6	0,7	CR0853080	2.837,00 €
	V6FEV7E	Cocina vitrocerámica 4 zonas con horno ventilado 1 de 1,2 Kw diam. 14,5 cm. 1 de 1,8 Kw diam. 18 cm. 2 de 2,5 Kw diam. 22 cm. Potencia horno 4,2 Kw. Dimensiones de la cámara de cocción del horno 57x53x29,5 cm. 400 V 3N 50-60 Hz 230 V 3 50-60 Hz	70x65x87 12,2	0,7	CR0853150	3.437,00 €
	V6FEV7EP	Cocina vitrocerámica 4 zonas con horno ventilado 4 de 2,5 Kw diam. 22 cm. Potencia horno 4,2 Kw. Dimensiones de la cámara de cocción del horno 57x53x29,5 cm. 400 V 3N 50-60 Hz 230 V 3 50-60 Hz	70x65x87 14,2	0,7	CR0853160	3.541,00 €

MÓDULOS DE COCCION A INDUCCION

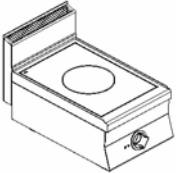
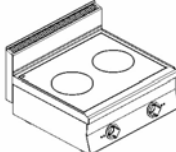
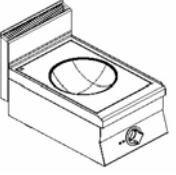
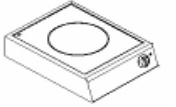
	MODELO	DESCRIPCIÓN	CM.AxPxH	KGS.	CÓDIGO	EUROS
			KW	M3		
	I64E	Top a inducción 1 zona 1 de 5 Kw diam. 22 cm. 400 V 3N 50-60 Hz	40x65x29,5 5	0,13	CR0853170	4.063,00 €
	I67E	Top a inducción 2 zonas 2 de 5 Kw diam. 22 cm. 400 V 3N 50-60 Hz	70x65x29,5 10	0,25	CR0853180	7.410,00 €
	IW64E	Top a inducción WOK 1 zona 1 de 5 Kw diam. 30 cm. 400 V 3N 50-60 Hz	40x65x29,5 5	0,13	CR0853570	4.519,00 €
	TT3435EU	Encimera de inducción sobremesa 1 de 3 Kw diam. 23 cm. 230 Vca 50 Hz	34x40,5x10,5 3	4 0,04	CR0954989	1.751,00 €

SERIE ENCASTRABLE - COCINAS ELECTRICAS

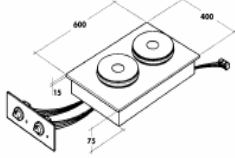
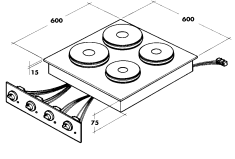
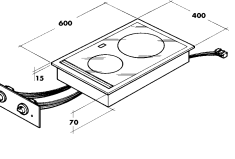
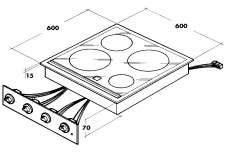
	MODELO	DESCRIPCIÓN	CM.AxPxH	KGS.	CÓDIGO	EUROS
			KW	M3		
	PCE 40D	Top 2 placas redondas 1 de 1,5 Kw diam. 18 cm. 1 de 2,6 Kw diam. 22 cm. 400 V 3N 50-60 Hz 230 V 3 50-60 Hz	40x60x7,5 4,1	0,03	MA10402402140	611,00 €
	PCE 40DB	Top 2 placas redondas con box de mandos 1 de 1,5 Kw diam. 18 cm. 1 de 2,6 Kw diam. 22 cm. 400 V 3N 50-60 Hz 230 V 3 50-60 Hz	40x60x29,5 4,1	0,03	MA10402403140	694,00 €
	PCE 60D	Top 4 placas redondas 2 de 1,5 Kw diam. 18 cm. 2 de 2,6 Kw diam. 22 cm. 400 V 3N 50-60 Hz 230 V 3 50-60 Hz	60X60X7,5 8,2	0,04	MA10402404140	948,00 €
	PCE 60DB	Top 4 placas redondas con box de mandos 2 de 1,5 Kw diam. 18 cm. 2 de 2,6 Kw diam. 22 cm. 400 V 3N 50-60 Hz 230 V 3 50-60 Hz	60X60X7,5 8,2	0,04	MA10402405140	997,00 €
	PCVE 40D	Top vitroceramica 2 zonas 1 de 1,8 Kw diam. 18 cm. 1 de 2,4 Kw diam. 24 cm. 400 V 3N 50-60 Hz 230 V 3 50-60 Hz	40X60X7 4,2	0,03	MA10402406140	1.240,00 €
	PCVE 40DB	Top vitroceramica 2 zonas con box de mandos 1 de 1,8 Kw diam. 18 cm. 1 de 2,4 Kw diam. 24 cm. 400 V 3N 50-60 Hz 230 V 3 50-60 Hz	40X60X7 4,2	0,03	MA10402407140	1.321,00 €
	PCVE 60D	Top vitroceramica 4 zonas 1 de 1,2 Kw diam. 14,5 cm. 1 de 1,8 Kw diam. 18 cm. 2 de 2,4 Kw diam. 22 cm. 400 V 3N 50-60 Hz 230 V 3 50-60 Hz	70x60x29,5 7,8	0,004	MA10402408140	1.725,00 €
	PCVE 60DB	Top vitroceramica 4 zonas con box de mandos 1 de 1,2 Kw diam. 14,5 cm. 1 de 1,8 Kw diam. 18 cm. 2 de 2,4 Kw diam. 22 cm. 400 V 3N 50-60 Hz 230 V 3 50-60 Hz	70x60x29,5 7,8	0,004	MA10402409140	1.804,00 €

SERIE ENCASTRABLE - COCINAS GAS

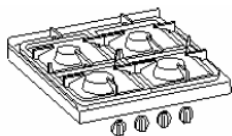
	MODELO	DESCRIPCIÓN	CM.AxPxH	KGS.	CÓDIGO	EUROS
			KW	M3		
	PCGD 41	Plano de cocción con 2 fuegos a gas 1 Quemador 3,5 Kw 1 Quemador 5,5 Kw	40x60x25 9	0,09	MA10403606000	863,00 €
	PCGD 61	Plano de cocción con 4 fuegos a gas 2 Quemadores 3,5 Kw 2 Quemadores 5,5 Kw	60x60x25 18	0,14	MA10403607000	1.379,00 €

FRY TOP ELECTRICOS

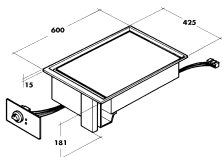
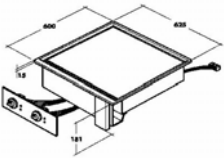
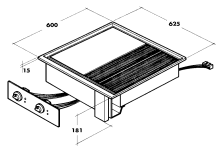
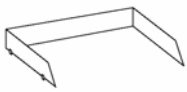
	FTE 40D	Placa lisa en acero especial. Termostato de control de temperatura 50-320°C. Tiempo respuesta 12 min Superficie de cocción 21,9 dm2 400 V 3N 50-60 Hz	42,5x60x18 3,9	0,07	MA10402410140	927,00 €
	FTE 40DB	Mismas características que FTE-40D con Box de Mandos	42,5x60x18 3,9	0,07	MA10402411140	1.011,00 €
	FTE 60D	Placa lisa en acero especial. Termostato de control de temperatura 50-320°C. Tiempo respuesta 12 min Superficie de cocción 33 dm2 2 Zonas de cocción independientes 400 V 3N 50-60 Hz	62,5x60x18 7,8	0,1	MA10402412140	1.389,00 €
	FTE 60DB	Mismas características que FTE-60D con Box de Mandos	62,5x60x18 7,8	0,1	MA10402413140	1.476,00 €
	FTE-60DR	Placa 1/2 Lisa y 1/2 ranurada Termostato de control de temperatura 50-320°C. Tiempo respuesta 12 min Superficie de cocción 33 dm2 2 Zonas de cocción independientes 400 V 3N 50-60 Hz	62,5x60x18 7,8	0,1	MA10402414140	1.556,00 €
	FTE 60DRB	Mismas características que FTE-60DR con Box de Mandos	62,5x60x18 7,8	0,1	MA10402415140	1.641,00 €
	PSFTE40D	Módulo antisalpicoado fry top de 40			MA10452669000	130,00 €
	PSFTE60D	Módulo antisalpicoado fry top de 60			MA10405270000	170,00 €

COCINAS A GAS SERIE 70

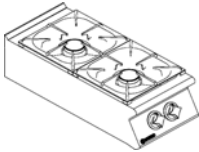
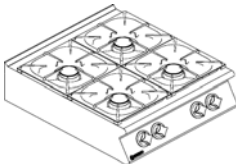
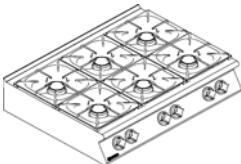
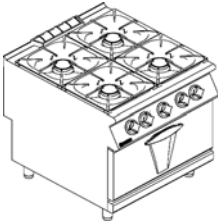
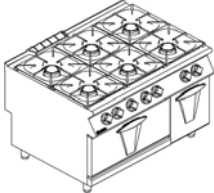
	MODELO	DESCRIPCIÓN	CM.AxPxH	KGS.	CÓDIGO	EUROS
			KW	M3		
	NC74G12	Top 2 fuegos. 2 Quemadores de 6 Kw.	40x73x25 12	0,08	CR0598000	1.084,00 €
	NC78G24	Top 4 fuegos. 4 Quemadores de 6 Kw.	80x73x25 24	0,16	CR0598010	1.793,00 €
	NC712G36	Top 6 fuegos. 6 Quemadores de 6 Kw.	120x73x25 36	0,24	CR0598020	2.569,00 €
	NC7FG8G32	Monoblock 4 fuegos y horno a gas dotada de rejilla en acero cromado mod. XBF-GGN2/1. 4 Quemadores de 6 Kw. 1 Quemador horno de 8 Kw.	80x73x87 32	0,56	CR0598090	3.408,00 €
	NC7FG12G44	Monoblock 6 fuegos, horno a gas y armario neutro. Dotada de rejilla en acero cromado mod. XBF-GGN2/1. 6 Quemadores de 6 Kw. 1 Quemador horno de 8 Kw.	120x73x87 44	0,84	CR0598100	4.635,00 €

COCINAS CON HORNO MAXI SERIE 70

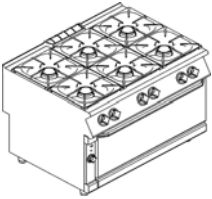
	NC7FGM12G	Monoblock 6 fuegos y horno maxi a gas a gas dotada de maxi-rejilla en acero cromado mod. XBF7MG. Dim. de la cámara de cocción 93,5x64x40cm. 6 Quemadores de 6 Kw. 1 Quemador horno de 10 Kw.	120x73x87 46	0,84	CR0598160	4.981,00 €
--	------------------	--	------------------------	------	-----------	-------------------

ACCESORIOS PARA HORNO MAXI SERIE 70

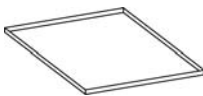
	XBF9M-G	Rejilla en acero cromado para horno maxi.	93x62	0,31	MA973777000	122,00 €
	XBF9M-T	Bandeja para horno maxi.	93x62x1,6	0,01	MA973778000	113,00 €

COCINAS MIXTAS CON HORNO SERIE 70

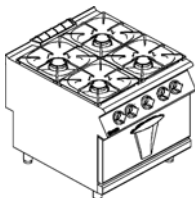
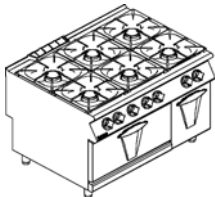
	MODELO	DESCRIPCIÓN	CM.AxPxH	KGS.	CÓDIGO	EUROS
			KW	M3		
	NC7FE8G24	Monoblock 4 fuegos y horno eléctrico dotado de rejilla en acero cromado mod.XBF7MG 4 Quemadores de 6 Kw Resistencia horno de 6Kw Alimentación: VAC400-3N 50/60Hz	80x73x87 24g 6e	0,56	CR0598140	3.837,00 €
	NC7FE12G36	Monoblock 6 fuegos, horno eléctrico y armario neutro. Dotada de rejilla en acero cromado mod. XBF7MG 6 Quemadores de 6 Kw Resistencia horno de 6Kw Alimentación: VAC400-3N 50/60Hz	120x73x87 36g 6e	0,84	CR0598150	4.961,00 €

ACCESORIOS PARA COCINAS FUEGOS ABIERTOS SERIE 70

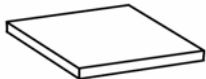
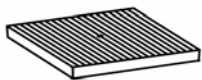
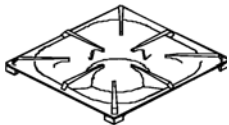
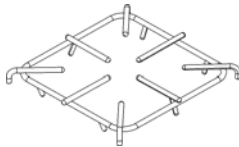
	NXC7PL	Placa lisa en fundición monofuego para quemadores de 6 Kw, potencia máxima de utilización 3,5 Kw.	35x35x3		CR0599790	136,00 €
	NXC7PR	Placa ranurada en fundición monofuego para quemadores de 6 Kw, potencia máxima de utilización 3,5 Kw.	35x35x4		CR0599780	136,00 €
	NGP7G	Rejilla en fundición	39,5x28,5		CR0592420	101,00 €
	NGP7S	Rejilla en varilla de acero inox Aisi 304 para un fuego.			CR0592890	181,00 €
	NXCAPZ	Kit encendido piezoelectrónico para 1 fuego.			CR0592020	46,00 €

PLACAS RADIANTES SERIE 70

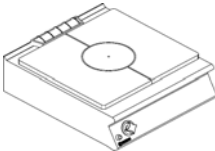
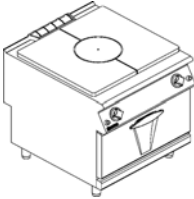
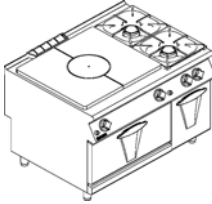
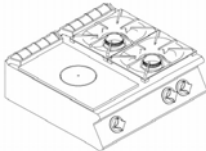
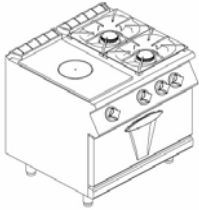
	MODELO	DESCRIPCIÓN	CM.AxPxH	KGS.	CÓDIGO	EUROS
			KW	M3		
	NT78G	Top 1 placa radiante con gancho en acero cromado para elevación anillo de inspección. 1 Quemador de 9 Kw.	80x73x25 9	0,16	CR0598290	1.955,00 €
	NT7FG8G	Monoblock 1 placa y horno a gas dotado de rejilla en acero cromado XBF-GGN2/1. Gancho en acero cromado para elevación anillo de inspección. 1 Quemador placa de 9 Kw. 1 Quemador horno de 8 Kw.	80x73x87 17	0,56	CR0598300	3.651,00 €
	NT7FG12G	Monoblock 1 placa y 2 fuegos horno a gas y armario neutro, dotado de rejilla e acero cromad XBF7MG. Gancho en acero cromado para elevación anillo de inspección. 1 Quemador placa de 9 Kw. 2 Quemadores de 6 Kw. 1 Quemador horno de 8 Kw.	120x73x87 29	0,84	CR0598310	5.073,00 €
	NS78GS	Top 1 placa y 2 fuegos a gas compuesto por 2 fuegos y placa a izquierda 1 Quemador placa de 6 Kw. 2 Quemadores de 6 Kw.	80x73x25 18	0,15	CR0599680	2.161,00 €
	NS7FG8GS	Monoblock 1 placa, 2 fuegos y horno a gas compuesto por 2 fuegos y placa a izquierda 1 Quemador placa de 6 Kw. 2 Quemadores de 6 Kw. 1 Quemador horno de 8 Kw.	80x73x87 26	0,55	CR0599750	3.776,00 €

COCINAS ELECTRICAS SERIE 70

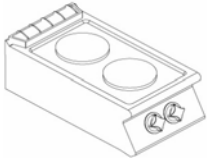
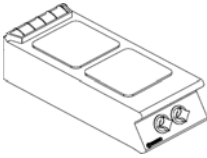
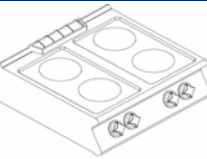
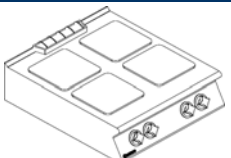
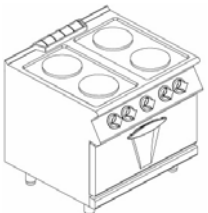
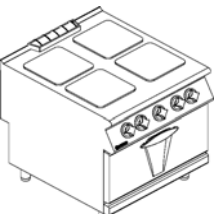
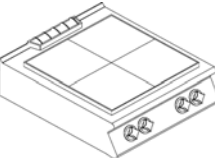
	MODELO	DESCRIPCIÓN	CM.AxPxH	KGS.	CÓDIGO	EUROS
			KW	M3		
	NC74EC	Top 2 placas redondas de 2,6 Kw. Alimentación: VAC400-3N 50/60Hz conmutable a VAC230-3N	40x73x25 5,2	0,08	CR0598190	1.122,00 €
	NC74EQC	Top 2 placas cuadradas de 2,6 Kw. Alimentación: VAC400-3N 50/60Hz conmutable a VAC230-3N	40x73x25 5,2	0,08	CR0599270	1.703,00 €
	NC78EC	Top 4 placas redondas de 2,6 Kw. Alimentación: VAC400-3N 50/60Hz conmutable a VAC230-3N	80x73x25 10,4	0,16	CR0598210	1.569,00 €
	NC78EQC	Top 4 placas cuadradas de 2,6 Kw. Alimentación: VAC400-3N 50/60Hz conmutable a VAC230-3N	80x73x25 10,4	0,16	CR0599290	2.912,00 €
	NC7FE8E	Monoblock 4 placas redondas de 2,6 Kw y horno eléctrico dotado de rejilla en acero cromado XBF-GGN2/1. Horno eléctrico de 6 Kw. Alimentación: VAC400-3N 50/60Hz	80x73x87 16,4	0,56	CR0598230	3.724,00 €
	NC7FE8E2	Monoblock 4 placas redondas de 2,6 Kw y horno eléctrico dotado de rejilla en acero cromado XBF-GGN2/1. Horno eléctrico de 6 Kw. Alimentación: VAC230-3 50/60Hz	80x73x87 16,4	0,56	CR0598240	3.984,00 €
	NC7FE8EQ	Monoblock 4 placas cuadradas de 2,6 Kw y horno eléctrico dotado de rejilla en acero cromado XBF-GGN2/1. Horno eléctrico de 6 Kw. Alimentación: VAC400-3N 50/60Hz	80x73x87 16,4	0,56	CR0599650	4.755,00 €
	NC7FE8EQ2	Monoblock 4 placas cuadradas de 2,6 Kw y horno eléctrico dotado de rejilla en acero cromado XBF-GGN2/1. Horno eléctrico de 6 Kw. Alimentación: VAC230-3 50/60Hz	80x73x87 16,4	0,56	CR0599660	5.002,00 €
	NCT78EC	Top placa única en acero, eléctrica con 4 zonas independientes de cocción de 2,5 Kw. Alimentación: VAC400-3N 50/60Hz conmutable a VAC230-3N	80x73x25 10	0,16	CR0598280	4.104,00 €

COCINAS ELECTRICAS SERIE 70

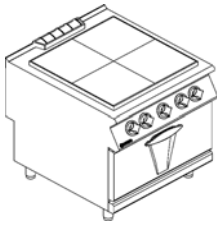
	MODELO	DESCRIPCIÓN	CM.AxPxH	KGS.	CÓDIGO	EUROS
			KW	M3		
	NCT7FE8E	Monoblock 4 zonas de cocción independientes y horno eléctrico dotado de rejilla en acero cromado XBF-GGN2/1. 4 Zonas de cocción de 2,5 Kw. Resistencia horno 6 Kw. Alimentación: VAC400-3N 50/60Hz	80x73x87 16	0,56	CR0598270	6.176,00 €
	NCT7FE8E2	Monoblock 4 zonas de cocción independientes y horno eléctrico dotado de rejilla en acero cromado XBF-GGN2/1. 4 Zonas de cocción de 2,5 Kw. Resistencia horno 6 Kw. Alimentación: VAC230-3 50/60Hz	80x73x87 16	0,56	CR0598400	6.094,00 €

COCINAS CON PLANO EN VITROCERAMICA SERIE 70

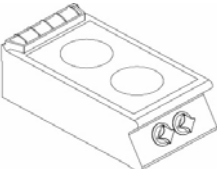
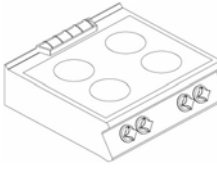
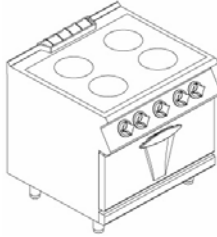
	NV74EC	Top 2 zonas de cocción de 2,5 Kw. Alimentación: VAC400-3N 50/60Hz conmutable a VAC230-3N	40x73x25 5	0,08	CR0598250	1.910,00 €
	NV78EC	Top 4 zonas de cocción de 2,5 Kw. Alimentación: VAC400-3N 50/60Hz conmutable a VAC230-3N	80x73x25 10	0,16	CR0598260	3.143,00 €
	NV7FE8E	Monoblock 4 zonas de cocción de 2,5 Kw y horno eléctrico dotado de rejilla en acero cromado XBF-GGN2/1. Resistencia horno 6 Kw. Alimentación: VAC400-3N 50/60Hz	80x73x87 16	0,56	CR0599460	4.708,00 €
	NV7FE8E2	Monoblock 4 zonas de cocción de 2,5 Kw y horno eléctrico dotado de rejilla en acero cromado XBF-GGN2/1. Resistencia horno 6 Kw. Alimentación: VAC230-3 50/60Hz	80x73x87 16	0,56	CR0599470	4.942,00 €

MANTENEDOR DE FRITOS ELECTRICO SERIE 70

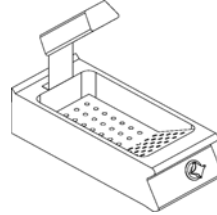
	NSP74E	Mantenedor de fritos con cubeta GN 1/1 H=150mm y falso fondo. Calentamiento mediante resistencia inferior y mantenedor de infrarrojos. Alimentación: VAC230-3 50/60Hz	40x73x25	0,08	CR0598030	1.563,00 €
---	---------------	---	----------	------	-----------	-------------------

COCINAS ELECTRICAS DE INDUCCION SERIE 70

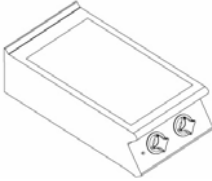
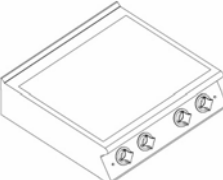
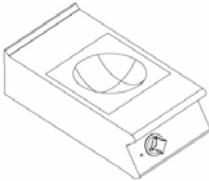
	MODELO	DESCRIPCION	CM.AxPxH	KGS.	CODIGO	EUROS
			KW	M3		
	NI74TE	Top a inducción 2 zonas de cocción de 3,5 Kw. diámetro 22 cm. Alimentación: VAC400-3N 50/60Hz	40x73x25 7	0,08	CR0598200	7.711,00 €
	NI78TE	Top a inducción 4 zonas de cocción de 3,5 Kw. diámetro 22 cm. Alimentación: VAC400-3N 50/60Hz	80x73x25 14	0,16	CR0598220	11.955,00 €
	NIW74TE	Top a inducción WOK 1 zona de cocción de 5 Kw. diámetro 22 cm. Alimentación: VAC400-3N 50/60Hz	40x73x25 5	0,08	CR0599280	4.691,00 €
	NIW74TE2	Top a inducción WOK 1 zona de cocción de 5 Kw. diámetro 22 cm. Alimentación: VAC230-3 50/60Hz	40x73x25 5	0,08	CR0597780	4.791,00 €

MULTIPLA SERIE 70

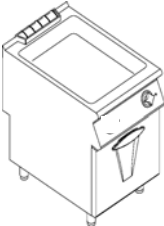
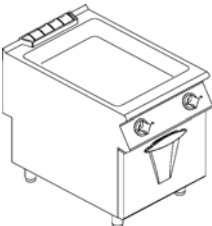
	NVB74E	Monoblock multifunción eléctrico , cuba GN 1/1 profundidad 150 mm. con fondo pulido a espejo en acero inox Aisi 304. 2 Zonas de cocción. Alimentación: VAC400-3N 50/60Hz	40x73x87 4	0,28	CR0598320	2.999,00 €
	NVB74E2	Monoblock multifunción eléctrico , cuba GN 1/1 profundidad 150 mm. con fondo pulido a espejo en acero inox Aisi 304. 2 Zonas de cocción. Alimentación: VAC230-3 50/60Hz	40x73x87 4	0,28	CR0597820	3.063,00 €
	NVB76E	Monoblock multifunción eléctrico , cuba GN 2/1 profundidad 150 mm. con fondo pulido a espejo en acero inox Aisi 304. 2 Zonas de cocción. Alimentación: VAC400-3N 50/60Hz	60x73x87 8,1	0,49	CR0599550	3.933,00 €
	NVB76E2	Monoblock multifunción eléctrico , cuba GN 2/1 profundidad 150 mm. con fondo pulido a espejo en acero inox Aisi 304. 2 Zonas de cocción. Alimentación: VAC230-3 50/60Hz	60x73x87 8,1	0,49	CR0597830	4.000,00 €

COCINAS A GAS SERIE 90

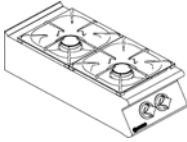
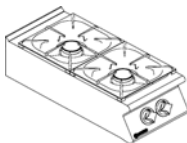
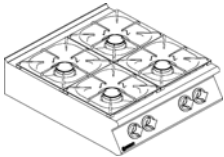
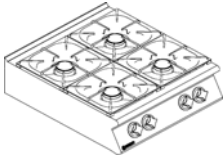
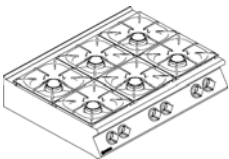
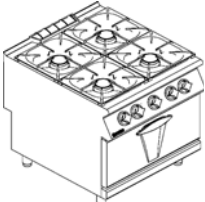
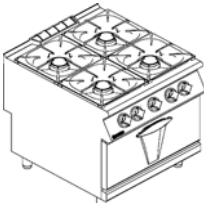
	MODELO	DESCRIPCIÓN	CM.AxPxH	KGS.	CÓDIGO	EUROS
			KW	M3		
	NC94G16	Top 2 fuegos. 1 Quemador de 6 Kw. 1 Quemador de 10 Kw.	40x90x25 16	0,1	CR0590000	1.519,00 €
	NC94G20	Top 2 fuegos potenciados 2 Quemadores de 10 Kw	40x90x25 20	0,1	CR0590030	1.597,00 €
	NC98G28	Top 4 fuegos. 3 Quemadores de 6 Kw. 1 Quemador de 10 Kw.	80x90x25 28	0,25	CR0590010	2.298,00 €
	NC98G40	Top 4 fuegos potenciados. 4 Quemadores de 10 Kw.	80x90x25 40	0,25	CR0590040	2.414,00 €
	NC912G44	Top 6 fuegos. 4 Quemadores de 6 Kw. 2 Quemadores de 10 Kw.	120x90x25 44	0,3	CR0590020	3.191,00 €
	NC9FG8G32	Monoblock 4 fuegos y horno a gas dotada de rejilla en acero cromado mod. XBF-GGN2/1. 4 Quemadores de 6 Kw. 1 Quemador horno de 8 Kw.	80x90x87 32	1	CR0590080	3.933,00 €
	NC9FG8G36	Monoblock 4 fuegos potenciada sobre horno a gas dotada de rejilla en acero cromado mod. XBF-GGN2/1. 3 Quemadores de 6 Kw. 1 Quemador de 10 Kw. 1 Quemador horno de 8 Kw.	80x90x87 36	1	CR0590090	4.051,00 €

COCINAS CON HORNO SERIE 90

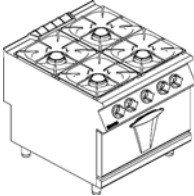
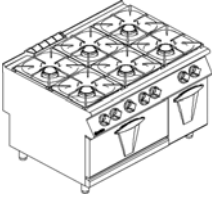
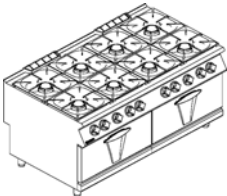
	MODELO	DESCRIPCIÓN	CM.AxPxH	KGS.	CÓDIGO	EUROS
			KW	M3		
	NC9FG8G48	Monoblock 4 fuegos potenciada sobre horno a gas dotada de rejilla en acero cromado mod. XBF-GGN2/1. 4 Quemadores de 10 Kw. 1 Quemador horno de 8 Kw.	80x90x87 48	1	CR0590120	4.169,00 €
	NC9FG12G52	Monoblock 6 fuegos, horno a gas y armario neutro. Dotada de rejilla en acero cromado mod. XBF-GGN2/1. 4 Quemadores de 6 Kw. 2 Quemadores de 10 Kw. 1 Quemador horno de 8 Kw.	120x90x87 52	1,2	CR0590100	5.573,00 €
	NC9FG16G72	Monoblock 8 fuegos potenciada sobre horno a gas dotada de rejilla en acero cromado mod. XBF-GGN2/1. 6 Quemadores de 6 Kw. 2 Quemadores de 10 Kw. 2 Quemador horno de 8 Kw.	160x90x87 72	1,5	CR0590110	7.746,00 €

COCINAS CON HORNO MAXI SERIE 90

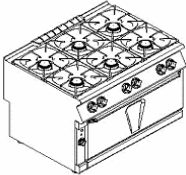
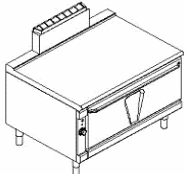
	NC9FGM12G	Monoblock 6 fuegos y horno maxi a gas dotada de maxi-rejilla en acero cromado mod. XBF9M-G. Dim. de la cámara de cocción 93,5x64x40cm. 4 Quemadores de 6 Kw. 2 Quemadores de 10 Kw. 1 Quemador horno de 10 Kw.	120x90x87 54	1,2	CR0590160	5.824,00 €
	NBF912GH	Horno maxi a gas dotado de maxi-rejilla en acero cromado mod. XBF9M-G Dim. Plano de trabajo superior con borde redondeado. De serie compuerta en acero inox.	120x90x87 10	1,2	CR0591300	3.685,00 €

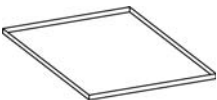

ACCESORIOS PARA HORNO MAXI SERIE 90

	XBF9M-G	Rejilla en acero cromado para horno maxi.	93x62		MA9737700	122,00 €
	XBF9M-T	Bandeja para horno maxi.	93x62x1,6		MA9737800	113,00 €

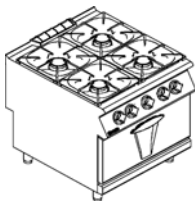
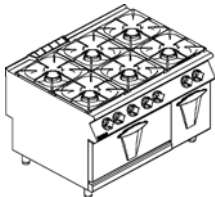

COCINAS MIXTAS CON HORNO SERIE 90

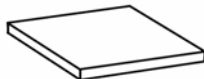
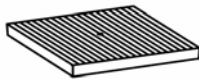
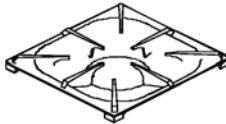
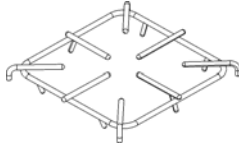
	MODELO	DESCRIPCIÓN	CM.AxPxH	KGS.	CÓDIGO	EUROS
			KW	M3		
	NC9FE8G28	Monoblock 4 fuegos y horno eléctrico dotado de rejilla en acero cromado mod. XBF-GGN2/1. 3 Quemadores de 6 Kw 1 Quemador de 10 Kw Resistencia horno de 6Kw Alimentación: VAC400-3N 50/60Hz	80x90x87 28g 6e	1	CR0590140	4.632,00 €
	NC9FE12G44	Monoblock 6 fuegos, horno eléctrico y armario neutro. Dotado de rejilla en acero cromado mod. XBF-GGN2/1. 4 Quemadores de 6 Kw 2 Quemadores de 10 Kw Resistencia horno de 6Kw Alimentación: VAC400-3N 50/60Hz	120x90x87 44g 6e	1,2	CR0590150	6.149,00 €

ACCESORIOS PARA COCINAS FUEGOS ABIERTOS SERIE 90

	NXC9PL	Placa lisa en fundición monofuego para quemadores de 6 Kw, potencia máxima de utilización 3,5 Kw.	35x35x3		CR059200	231,00 €
	NXC9PR	Placa ranurada en fundición monofuego para quemadores de 6 Kw, potencia máxima de utilización 3,5 Kw.	35x35x4		CR0592010	183,00 €
	NGPG	Rejilla en fundición	39,5x37		CR0592900	110,00 €
	NGPS	Rejilla en varilla de acero inox Aisi 304 para un fuego.	39,5x37		CR0592880	183,00 €
	NXCAPZ	Kit encendido piezoelectrónico para 1 fuego.			CR0592020	46,00 €
	NXKB6	Kit quemador de 6 Kw.			CR0592030	110,00 €
	NXKB10	Kit quemador de 10 Kw.			CR0592040	134,00 €

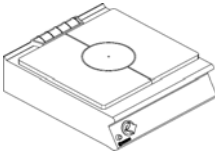
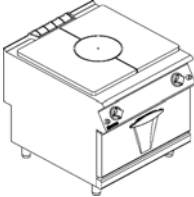
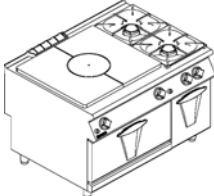
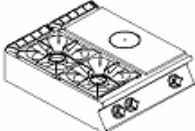
PLACAS RADIANTES SERIE 90

	MODELO	DESCRIPCIÓN	CM.AxPxH	KGS.	CÓDIGO	EUROS
			KW	M3		
	NT98G	Top 1 placa con gancho en acero cromado para elevación anillo de inspección. 1 Quemador de 11 Kw.	80x90x25 11	0,25	CR0590290	2.416,00 €
	NT9FG8G	Monoblock 1 placa y horno a gas dotado de rejilla en acero cromado XBF-GGN2/1. Gancho en acero cromado para elevación anillo de inspección. 1 Quemador placa de 11 Kw. 1 Quemador horno de 8 Kw.	80x90x87 19	1	CR0590300	4.529,00 €
	NT9FG12G	Monoblock 1 placa y 2 fuegos horno a gas y armario neutro, dotado de rejilla e acero cromad XBF-GGN2/1. Gancho en acero cromado para elevación anillo de inspección. 1 Quemador placa de 11 Kw. 1 Quemador de 6 Kw. 1 Quemador de 10 Kw. 1 Quemador horno de 8 Kw.	120x90x87 35	1,2	CR0590310	6.189,00 €
	NS98GD	Top 1 placa y 2 fuegos a gas compuesto por 2 fuegos y plancha a derecha 1 Quemador placa de 7 Kw. 1 Quemador de 6 Kw. 1 Quemador de 10 Kw.	80x90x25 23	0,25	CR0953490	2.664,00 €
	NS9FG8GD	Monoblock 1 placa, 2 fuegos y horno a gas compuesto por 2 fuegos y plancha a derecha 1 Quemador placa de 7 Kw. 1 Quemador de 6 Kw. 1 Quemador de 10 Kw. 1 Quemador horno de 8 Kw.	80x90x87 31	1	CR0953510	4.686,00 €

COCINAS ELECTRICAS SERIE 90

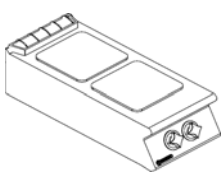
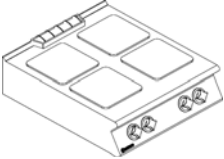
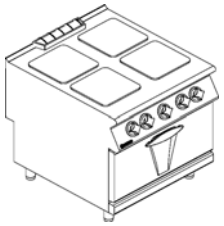
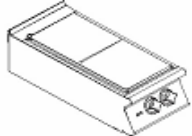
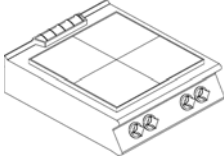
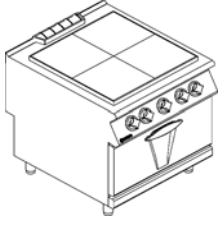
	MODELO	DESCRIPCIÓN	CM.AxPxH	KGS.	CÓDIGO	EUROS
			KW	M3		
	NC94E	Top 2 placas cuadradas de 4 Kw. Alimentación: VAC400-3N 50/60Hz	40x90x25 8	0,1	CR0590190	2.102,00 €
	NC94E2	Top 2 placas cuadradas de 4 Kw. Alimentación: VAC230-3 50/60Hz	40x90x25 8	0,1	CR0590200	2.193,00 €
	NC98E	Top 4 placas cuadradas de 4 Kw. Alimentación: VAC400-3N 50/60Hz	80x90x25 16	0,25	CR0590210	3.687,00 €
	NC98E2	Top 4 placas cuadradas de 4 Kw. Alimentación: VAC230-3 50/60Hz	80x90x25 16	0,25	CR0590220	3.872,00 €
	NC9FE8E	Monoblock 4 placas cuadradas de 4 Kw y horno eléctrico dotado de rejilla en acero cromado XBF-GGN2/1. Horno eléctrico de 6 Kw. Alimentación: VAC400-3N 50/60Hz	80x90x87 22	1	CR0590230	5.599,00 €
	NC9FE8E2	Monoblock 4 placas cuadradas idem anterior Alimentación: VAC230-3 50/60Hz	80x90x87 22	1	CR0590240	5.886,00 €
	NCT94E	Top placa única en acero, eléctrica con 2 zonas independientes de cocción de 4Kw. Alimentación: VAC400-3N 50/60Hz	40x90x25 8	0,1	CR0951680	2.941,00 €
	NCT94E2	Versión con alimentación a VAC230-3 50/60Hz	40x90x25 7	0,1	CR0951690	3.181,00 €
	NCT98E	Top placa única en acero, eléctrica con 4 zonas independientes de cocción de 4Kw. Alimentación: VAC400-3N 50/60Hz	80x90x25 16	0,25	CR0590280	5.411,00 €
	NCT98E2	Versión con alimentación a VAC230-3 50/60Hz	80x90x25 14	0,25	CR0590130	5.697,00 €
	NCT9FE8E	Monoblock 4 zonas de cocción independientes y horno eléctrico dotado de rejilla en acero cromado XBF-GGN2/1. 4 Zonas de cocción de 4 Kw. Resistencia horno 6 Kw. Alimentación: VAC400-3N 50/60Hz	80x90x87 22	1	CR0590270	7.678,00 €
	NCT9FE8E2	Versión con alimentación a VAC230-3 50/60Hz	80x90x87 20	1	CR0590400	7.964,00 €

COCINAS CON PLANO EN VITROCERAMICA SERIE 90

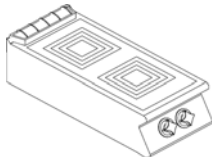
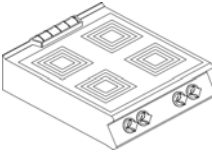
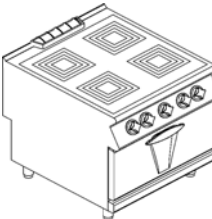
	MODELO	DESCRIPCIÓN	CM.AxPxH	KGS.	CÓDIGO	EUROS
			KW	M3		
	NV94E	Top 2 zonas de cocción de 4 Kw. diam. 300mm. Alimentación: VAC400-3N 50/60Hz	40x90x25 8	0,1	CR0590250	2.833,00 €
	NV94E2	Versión con alimentación a VAC230-3 50/60Hz	40x90x25 7	0,1	CR0590050	3.001,00 €
	NV98E	Top 4 zonas de cocción de 4 Kw. diam. 300mm. Alimentación: VAC400-3N 50/60Hz	80x90x25 16	0,25	CR0590260	4.290,00 €
	NV98E2	Versión con alimentación a VAC230-3 50/60Hz	80x90x25 14	0,25	CR0590060	4.576,00 €
	NV9FE8E	Monoblock 4 zonas de cocción de 4 Kw diam. 300mm y horno eléctrico dotado de rejilla en acero cromado XBF-GGN2/1. Resistencia horno 6 Kw. Alimentación: VAC400-3N 50/60Hz	80x90x87 22		CR0591460	6.431,00 €
	NV9FE8E2	Versión con alimentación a VAC230-3 50/60Hz	80x90x87 20		CR0591470	6.687,00 €

MULTIPLA SERIE 90

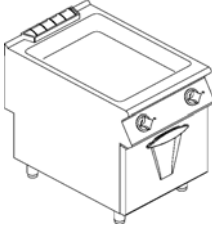
	NVB96E	Monoblock multifunción eléctrico , cuba profundidad 100mm con fondo pulido a espejo en acero inox Aisi 304. 2 Zonas de cocción. Alimentación: VAC400-3N 50/60Hz	60x90x87 8,1		CR0590320	5.135,00 €
---	---------------	---	------------------------	--	-----------	-------------------

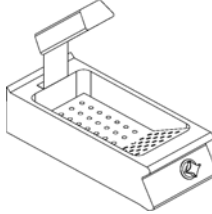

MANTENEDOR DE FRITOS ELECTRICO SERIE 90

	NSP94E	Mantenedor de fritos con cubeta GN 1/1 H=150mm y falso fondo. Calentamiento mediante resistencia inferior y mantenedor de infrarrojos. Alimentación: VAC230-3 50/60Hz	40x90x25 2	0,1	CR0590680	1.709,00 €
---	---------------	---	----------------------	-----	-----------	-------------------

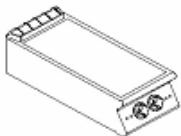
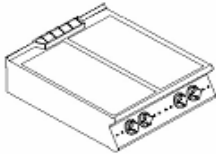
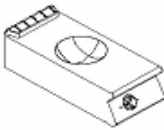
COCINAS ELECTRICAS DE INDUCCION SERIE 90

	MODELO	DESCRIPCION	CM.AxPxH	KGS.	CODIGO	EUROS
			KW	M3		
	NI94TE	Top a inducción 2 zonas de cocción de 5 Kw. Alimentación: VAC400-3N 50/60Hz	40x90x25 10		CR0591970	8.403,00 €
	NITC94TE	Top a inducción 1 zona de cocción de 14 Kw. Alimentación: VAC400-3N 50/60Hz	40x90x25 14		CR0591570	11.691,00 €
	NI98TE	Top a inducción 4 zonas de cocción de 5 Kw. Alimentación: VAC400-3N 50/60Hz	80x90x25 20		CR0591980	13.357,00 €
	NITC98TE	Top a inducción 2 zonas de cocción de 14 Kw. Alimentación: VAC400-3N 50/60Hz	80x90x25 28		CR0591580	22.580,00 €
	NIW94TE	Cocina top WOK a inducción 1 Zona de cocción independientes de 5 Kw de diam. 30cm. Alimentación: VAC400-3 50/60Hz	40x90x25 5		CR0591490	4.815,00 €

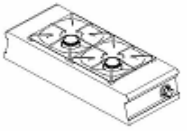
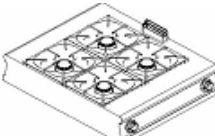

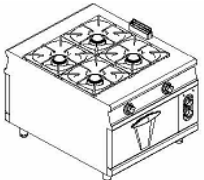

COCINAS A GAS SERIE 110

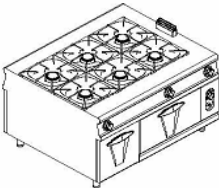
	MODELO	DESCRIPCIÓN	CM.AxPxH	KGS.	CÓDIGO	EUROS
			KW	M3		
	NC11C9G16	Top pasante 2 fuegos sobre un frente. 1 Quemador de 6 Kw. 1 Quemador de 10 Kw.	90x55x23 16	0,13	CR0850000	2.183,00 €
	NC11C9G20	Top pasante 2 fuegos sobre un frente. 2 Quemadores de 10 Kw.	90x55x23 20	0,13	CR0850010	2.422,00 €
	NC114G16	Top pasante 2 fuegos. 1 Quemador de 6 Kw. 1 Quemador de 10 Kw.	45x110x23 16	0,15	CR0850020	2.398,00 €
	NC114G20	Top pasante 2 fuegos. 2 Quemadores de 10 Kw.	45x110x23 20	0,15	CR0850030	2.417,00 €
	NC119G28	Top pasante 4 fuegos. 3 Quemadores de 6 Kw. 1 Quemador de 10 Kw.	90x110x23 28	0,29	CR0850040	3.590,00 €
	NC119G40	Top pasante 4 fuegos. 4 Quemadores de 10 Kw.	90x110x23 40	0,29	CR0850050	3.806,00 €
	NC1113G40	Top pasante 6 fuegos. 5 Quemadores de 6 Kw. 1 Quemador de 10 Kw.	135x110x23 40	0,46	CR0850060	4.673,00 €
	NC1113G44	Top pasante 6 fuegos. 4 Quemadores de 6 Kw. 2 Quemador de 10 Kw.	135x110x23 44	0,46	CR0850070	4.785,00 €
	NC11FG9G40	Monoblock 4 fuegos y horno pasante a gas 3 Quemadores de 6 Kw. 1 Quemador de 10 Kw. Dimensiones de la cámara de cocción 53,9x101,8x29,2 cm. Potencia del horno 11 Kw.	90x110x90 39	0,98	CR0850080	6.625,00 €
	NC11FG9G52	Monoblock 4 fuegos y horno pasante a gas 4 Quemadores de 10 Kw. Dimensiones de la cámara de cocción 53,9x101,8x29,2 cm. Potencia del horno 11 Kw.	90x110x90 51	0,98	CR0850090	6.709,00 €
	NC11FE9G28	Monoblock 4 fuegos y horno pasante eléctrico 3 Quemadores de 6 Kw. 1 Quemador de 10 Kw. Horno eléctrico estático. Dimensiones de la cámara de cocción 53,9x101,8x29,2 cm. Potencia horno 9 Kw. Tensión VAC400-3N 50/60 Hz	90x110x90 28g 9e	0,98	CR0850100	6.574,00 €
	NC11FE9G40	Monoblock 4 fuegos y horno pasante eléctrico 4 Quemadores de 10 Kw. Horno eléctrico estático. Dimensiones de la cámara de cocción 53,9x101,8x29,2 cm. Potencia horno 9 Kw. Tensión VAC400-3N 50/60 Hz	90x110x90 40g 9e	0,98	CR0850110	6.650,00 €

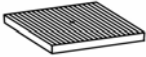

COCINAS A GAS SERIE 110

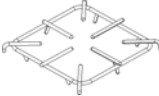
	MODELO	DESCRIPCIÓN	CM.AxPxH	KGS.	CÓDIGO	EUROS
			KW	M3		
	NC11FG13G56	Monoblock 6 fuegos, horno pasante a gas y armario neutro 4 Quemadores de 6 Kw. 2 Quemador de 10 Kw. Dimensiones de la cámara de cocción 53,9x101,8x29,2 cm. Potencia del horno 11 Kw.	135x110x90 55	1,5	CR0850120	8.167,00 €
	NC11FGC13G56	Monoblock 6 fuegos, horno pasante a gas y armario caliente eléctrico 4 Quemadores de 6 Kw. 2 Quemador de 10 Kw. Dimensiones de la cámara de cocción 53,9x101,8x29,2 cm. Potencia del horno 11 Kw. Potencia armario caliente 1,4 Kw. Tensión armario caliente VAC230 50/60 Hz	135x110x90 55g 1,4e	1,5	CR0850130	8.842,00 €
	NC11FE13G44	Monoblock 6 fuegos, horno pasante eléctrico y armario neutro 4 Quemadores de 6 Kw. 2 Quemador de 10 Kw. Horno eléctrico estático. Dimensiones de la cámara de cocción 53,9x101,8x29,2 cm. Potencia horno 9 Kw. Tensión VAC400-3N 50/60 Hz	135x110x90 44g 9e	1,5	CR0850140	8.271,00 €
	NC11FEC13G44	Monoblock 6 fuegos, horno pasante eléctrico y armario caliente eléctrico 4 Quemadores de 6 Kw. 2 Quemador de 10 Kw. Horno eléctrico estático. Dimensiones de la cámara de cocción 53,9x101,8x29,2 cm. Potencia horno 9 Kw. Tensión VAC400-3N 50/60 Hz Potencia armario caliente 1,4 Kw. Tensión armario caliente VAC230 50/60 Hz	90x110x90 44g 10,4e	1,5	CR0850150	8.946,00 €



ACCESORIOS PARA COCINAS FUEGOS ABIERTOS SERIE 110

	NXC9PL	Placa lisa en fundición 1 fuego para quemadores de 6 Kw, potencia máxima de utilización 3,5 Kw.	35x35x3		CR0592000	231,00 €
	NXC9PR	Placa ranurada en fundición 1 fuego para quemadores de 6 Kw, idem anterior	35x35x4		CR0592010	183,00 €
	NGPG	Rejilla en fundición para un fuego			CR0592900	110,00 €
	NGPS	Rejilla en varilla de acero inox Aisi 304 para un fuego.			CR0592880	183,00 €
	NXCAPZ	Kit encendido piezoelectrónico para 1 fuego.			CR0592020	46,00 €
	NXKB6	Kit quemador de 6 Kw.			CR592030	110,00 €
	NXKB10	Kit quemador de 10 Kw.			CR592040	134,00 €

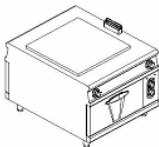
PLACAS RADIANTES SERIE 110

	MODELO	DESCRIPCIÓN	CM.AxPxH	KGS.	CÓDIGO	EUROS
			KW	M3		
	NT11V9G	Placa radiante gas pasante sobre base abierta. Calentamiento mediante 1 quemador en acero inox. Dimensiones de la placa 70x79,1 cm.	90x110x90 13		CR0850160	4.851,00 €
	NT11FG9G	Placa radiante gas monoblock pasante sobre horno pasante a gas. Calentamiento mediante 1 quemador en acero inox. Dimensiones de la placa 70x79,1 cm. Dimensiones de la cámara de cocción 53,9x101,8x29,2 cm. Potencia del horno 11 Kw.	90x110x90 24		CR0850170	8.130,00 €
	NC11FE9G	Placa radiante gas monoblock pasante sobre horno pasante eléctrico. Calentamiento mediante 1 quemador en acero inox. Dimensiones de la placa 70x79,1 cm. Horno eléctrico estático. Dimensiones de la cámara de cocción 53,9x101,8x29,2 cm. Potencia horno 9 Kw. Tensión VAC400-3N 50/60 Hz	90x110x90 13g 9e		CR0850180	7.369,00 €
	NCT11V9E	Placa eléctrica pasante sobre base abierta Placa con cuatro zonas de cocción independientes de 4 Kw. cada una. Dimensiones placa 72x72x3 cm. Tensión VAC400-3N 50/60 Hz	90x110x90 16		CR0850190	6.228,00 €
	NCT11FE9E	Placa de cocción eléctrica pasante sobre horno pasante eléctrico. Placa con cuatro zonas de cocción independientes de 4 Kw. cada una. Dimensiones placa 72x72x3 cm. Horno eléctrico estático. Dimensiones de la cámara de cocción 53,9x101,8x29,2 cm. Potencia horno 9 Kw. Tensión VAC400-3N 50/60 Hz	90x110x90 25		CR0850200	7.935,00 €

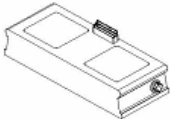
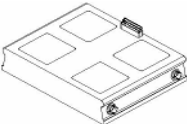
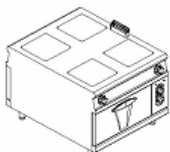
COCINAS CON PLANO EN VITROCERAMICA E INDUCCION SERIE 110

	NV114E	Top pasante con plano en vitrocerámica con 2 zonas de cocción independientes de 3,4 Kw. Tensión VAC400-3N 50/60 Hz	45x110x23 6,8		CR0850211	4.761,00 €
	NV119E	Top pasante con plano en vitrocerámica con 4 zonas de cocción independientes de 3,4 Kw. Tensión VAC400-3N 50/60 Hz	90x110x23 13,6		CR0850221	6.082,00 €
	NV11FE9E	Vitrocerámica pasante con horno pasante elect. 4 zonas de cocción independientes de 3,4 Kw. Horno eléctrico estático. Dimensiones de la cámara de cocción 53,9x101,8x29,2 cm. Potencia horno 9 Kw. Tensión VAC400-3N 50/60 Hz	90x110x90 22,6		CR0850231	8.869,00 €
	NI11C9E	Inducción pasante a un frente sobre base abierta 2 zonas de cocción independientes de 5 Kw. Diámetro 28 cm. Tensión VAC400-3N 50/60 Hz	90x55x90 10		CR0850240	11.018,00 €



Modelo	P.V.P.
CQL-2FH	535 €
CQL-3FH	685 €

Cocina contruida en acero inoxidable AISI 304.

Quemadores independientes con tapa de latón mecanizado, fácilmente desmontable para su limpieza. Bandeja embutida en acero inox con válvula de seguridad y termopar para cada quemador. Bandeja recoge grasas en acero inox. Tipo de Gas: GLP ó natural.



Modelo	P.V.P.
CQL-2FV.....	460 €
CQL-4F	750 €

MODELO	CQL-2FH	CQL-3FH	CQL-2FV	CQL-4F
Medidas (mm)*	660x490x240 (350)	990x490x240 (350)	375x780x240 (350)	765x780x240 (350)
Grifos	2	3	2	4
Potencia (kw)	15	22,5	15	30

*Ancho x Fondo x Alto



Modelo **P.V.P.**
101 Bimar35 €

Mueble en acero troquelado en color negro.
 Medidas: 400 x 400 x 180 mm.
 Potencia térmica: 8,8 Kw-gr/h 640.
 Presión (mbar): 28/30/37.



Modelo **P.V.P.**
103 Bimar C/Val172 €

Mueble de acero troquelado en color negro. Provisto de válvula de seguridad, termopar y llama piloto.
 Medidas: 400 x 400 x 180 mm.
 Potencia térmica: 8,8 Kw-gr/h 640.
 Presión (mbar): 28/30/37



Modelo **P.V.P.**
104 Bimar 3 Pies.....30 €

Soporte 3 pies en hierro fundido.
 Potencia térmica: 7,5 Kw-gr/h 544.
 Presión (mbar): 28/30/37
 Opción: rejilla de reducción para sartenes pequeñas.

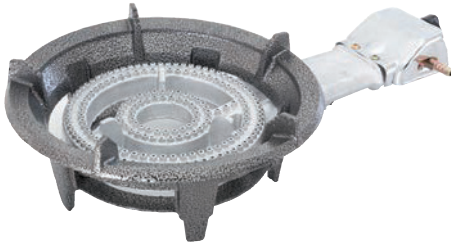

Modelo **P.V.P.**
105 Rociero100 €

Hornillo de doble fuego con posición Min-Máx y soporte sartén con encendido electrónico.
 Medidas: 600x350x140 mm.
 Potencia térmica: 8,8 Kw-gr/h 640.
 Presión (mbar): 28/30.
 Tipo Gas: GLP.



Modelo **P.V.P.**
106 Plancha Lisa/Estriad..... 50 €

Plancha doble uso lisa por una cara y estriada por otra, tratada con material antiadherente, adaptable a las cocinas del mercado.
 Medidas: 385 x 385 mm.



Modelo **P.V.P.**
100 Máxima Triple185 €

Mueble de tres fuegos en hierro fundido anticorrosivo, en color negro.
 Medidas: 700 x 300 x 160 mm.
 Potencia térmica: 12 Kw-gr/h 870.
 Presión (mbar): 28/30/37



Modelo **P.V.P.**
98 Micro..... 35 €
99 Micro Doble..... 70 €
107 Micro Triple.....100 €

Mueble en hierro con uno, dos o tres fuegos en hierro fundido especial para tapas a la cazuela.

MODELO	98 Micro	99 Micro Doble	103 Micro Triple
Medidas (mm)	26,5 x 26,5	50,5 x 26,5	75,5 x 26,5
Potencia Kw-g/h	2,5	5,0	7,5

Presión (mbar): 28/30/37



Parrilla regulable en altura. Quemadores de gran potencia 7 Kw cada uno.

Modelo **P.V.P.**
BG40600.....683 €

Modelo **P.V.P.**
BG60600.....965 €

Muebles en acero inoxidable
 Quemadores independientes en acero inoxidable, con encendido automático, llama piloto, válvula de seguridad y termopar. Piedra volcánica
 Cajón recoge grasas frontal. Placa acanalada regulable en altura
 Tipo de Gas: GLP ó Natural

MODELO	Medidas (mm)*	Potencia (w)	Peso (Kg)
BG40600	400x600x270	7000	29
BG60600	600x600x270	2 x 7000	43

*Ancho x Fondo x Alto

COCINAS A GAS. LÍNEA 600



Quemadores de gran potencia 6,2 Kw. cada uno.

Modelo **P.V.P.**
CG40600.....479 €

Modelo **P.V.P.**
CG60600.....775 €

Mueble en acero inoxidable
 Quemadores independientes de gran potencia con válvula de seguridad y termopar.
 Tipo de Gas: GLP ó Natural

MODELO	Medidas (mm)*	Potencia (w)	Peso (Kg)
CG40600	400x600x270	2 x 6200	15
CG60600	600x600x270	4 x 6200	23

*Ancho x Fondo x Alto



Modelo
CE40600420 €



Modelo
CE60600635 €



MODELO	Medidas (mm)*	Potencia (w)	Peso (Kg)
CE40600	400x600x270	2x2000(230v-50Hz)	16
CE60600	600x600x270	4x2000(230v-50Hz) Sistema de bajo consumo similar a 3 x 380	27

*Ancho x Fondo x Alto

Mueble en acero inoxidable
Funcionamiento eléctrico con selector de intensidad y posición de 0-7.

BAÑO MARÍA. LÍNEA 600-CUECE PASTA



Modelo
BM40600478 €

Mueble en acero inoxidable
Capacidad 2/3 GN.
Se suministra sin cubetas.
Provisto de termostato de trabajo y termostato de seguridad.
Grifo de vaciado
Potencia: 2000w - 230v / 50Hz
Medidas: 400x600x270 mm.



Modelo
CP40600 (2 Cestas)709 €
CP40600 (4 Cestas)798 €

Mueble, cubas y cestas en acero inoxidable
Grifo superior de llenado de agua.
Grifo de vaciado
Provisto de termostato.
Potencia: 3000w - 220v / 50Hz (2 cestas)
Medidas: 400x600x270 mm.



COCINAS A GAS 4 FUEGOS+HORNO. LÍNEA 700



Quemadores a gas potencia 6,2 Kw cada uno.



Horno a gas de gran potencia 7,1 Kw.

Modelo **P.V.P.**
CG4FH2.100 €

MODELO	Medidas (mm)*	Potencia (w)	Capacidad
CG4FH	700x700x850	31,9 Kw	4+1

*Ancho x Fondo x Alto

Construidos en acero inoxidable.
 Quemadores independientes muy potentes, con llama piloto.
 Bandeja embutida en acero inoxidable, con válvula de seguridad.
 Y termopar para cada quemador. Parrillas de fundición.
 Piezo eléctrico en horno con cierre estanco en silicona.
 Patas de acero inoxidable. Con altura regulable en 50 mm.
 Horno a gas con 7,1 Kw., de potencia, regulado termostáticamente de 160 a 300°C.
 Interior en acero inoxidable y guías extraíbles porta bandejas.
 Tipo de gas: GLP ó Natural.

HORNILLO DE PAVIMENTO. PAELLERO. LÍNEA 700



Modelo **P.V.P.**
HP-700725 €

Construidos en acero inoxidable.
 Parrilla de fundición.
 Quemadores con válvula de seguridad y termopar.
 Potencia: 30 Kw.
 Tipo de Gas: GLP ó Natural.
 Medidas: 700x700x550 mm.

Serie 550

Gama modular

Cocinas a gas

550 Series

Modular range

Gas cookers



CG-520/M



CG-520



CG-521

CG-521/G



KIT DE PUERTAS

DOORS KIT // KIT POUR PORTES // KIT PORTAS

CG-520

- Apertura a izquierda y derecha (ref. 70407000): + 360 €
Left and right opening // Ouverture gauche et droite //
Abertura esquerda e direita

OPCIONAL ENTREPAÑO

INNER SHELF // TRUPEAU EN
OPTION // ENTREPANO OPCIONAL

- CG-520 (ref. 83903000): + 125 €



Presión nominal / Working pressure / Pression de fonctionnement / Presão nominal: 50 mbar.

Dimensiones con embalaje	Packaging dimensions	Dimensions avec emballage	Dimensões da embalagem	(mm)	900 × 620 × 450	840 × 570 × 1.040	840 × 570 × 1.040	840 × 570 × 1.040	840 × 570 × 1.040
Volumen	Volume	Volume	Volume	(m³)	0.25	0.50	0.50	0.50	0.50
Dimensiones equipo	Equipment dimensions	Dimensions de l'équipement	Dimensões do equipamento	(mm)	800 × 550 × 270	800 × 550 × 850	800 × 550 × 850	800 × 550 × 850	800 × 550 × 850
Quemadores de encimera	Top burners	Brûleurs de dessus	Queimadores de encimeira	6.50 (kw)	1	1	1	1	
				8.00 (kw)	1	1	1	1	
Gratinador	Grate	Salamandre	Grill	4.00 (kw)	–	–	–	1	
Quemadores horno	Oven burners	Brûleurs four	Queimadores forno	5.00 (kw)	–	–	1	1	
Potencia	Power	Puissance	Potência	(kw)	14.50	14.50	19.50	23.50	
Consumos	Consumptions	Consommations	Consumos	GLP Kg/h	1.13	1.13	1.51	1.82	
				GN Nm³/h	1.53	1.53	2.06	2.49	
Peso bruto	Gross weight	Poids brut	Peso bruto	(kg)	48	78	100	100	
Peso neto	Net weight	Poids net	Peso líquido	(kg)	44	68	108	108	
Precio	Price	Prix	Preço	(€)	1.055	1.235	2.050	1.842	

Producto con color personalizable / Product with customizable colour / Produit avec couleur personnalisable / Possibilidade de personalizar producto quanto à cor – Pág. 266

REPAGAS, S.A. se reserva el derecho a modificar precios y especificaciones del material sin previo aviso / REPAGAS, S.A. reserves the right to modify prices and change the material specifications without prior notice / REPAGAS, S.A. reserva o direito de alterar preços bem como especificações dos produtos sem aviso prévio / REPAGAS, S.A. se réserve le droit de modifier les prix et les caractéristiques du matériel sans aucun avis.

Série 550

Gamme modulaire

Fourneaux à gaz

Série 550

Gama modular

Fogões a gás



CG-530/M



CG-531
CG-531/G



CG-530



KIT DE PUERTAS

DOORS KIT // KIT POUR PORTES // KIT PORTAS

CG-530

- Apertura a izquierda y derecha (ref. 70505000): + 360 €
Left and right opening // Ouverture gauche et droite // Abertura esquerda e direita

OPCIONAL ENTREPAÑO

INNER SHELF // TRUMEAU EN OPTION // ENTREPANO OPCIONAL

- CG-530 (ref. 83806000): + 145 €



Presión nominal / Working pressure / Pression de fonctionnement / Presão nominal: 50 mbar.

Dimensiones con embalaje	Packaging dimensions	Dimensions avec emballage	Dimensões da embalagem	(mm)	1.130 × 620 × 460	1.125 × 570 × 1.070	1.225 × 580 × 1.040	1.225 × 580 × 1.040	
Volumen	Volume	Volume	Volume	(m³)	0.32	0.69	0.74	0.74	
Dimensiones equipo	Equipment dimensions	Dimensions de l'équipement	Dimensões do equipamento	(mm)	1.205 × 550 × 270	1.205 × 550 × 850	1.205 × 550 × 850	1.205 × 550 × 850	
Quemadores de encimera	Top burners	Brûleurs de dessus	Queimadores de encimeira	6.50 (kw) 8.00 (kw)	1 2	1 2	1 2	1 2	
Gratinador	Grate	Salamandre	Grill	4.00 (kw)	–	–	–	1	
Quemadores horno	Oven burners	Brûleurs four	Queimadores forno	5.00 (kw)	–	–	1	1	
Potencia	Power	Puissance	Potência	(kw)	22.50	22.50	27.50	27.50	
Consumos	Consumptions	Consommations	Consumos	GLP Kg/h	1.74	1.74	2.13	2.44	
				GN Nm³/h	2.39	2.39	2.90	3.34	
Peso bruto	Gross weight	Poids brut	Peso bruto	(kg)	72	93	151	151	
Peso neto	Net weight	Poids net	Peso líquido	(kg)	61	86	142	142	
Precio	Price	Prix	Preço	(€)	1.389	1.622	2.425	2.236	

Producto con color personalizable / Product with customizable colour / Produit avec couleur personnalisable / Possibilidade de personalizar producto quanto à cor – Pág. 266

REPAGAS, S.A. se reserva el derecho a modificar precios y especificaciones del material sin previo aviso / REPAGAS, S.A. reserves the right to modify prices and change the material specifications without prior notice / REPAGAS, S.A. reserva o direito de alterar preços bem como especificações dos produtos sem aviso prévio / REPAGAS, S.A. se réserve le droit de modifier les prix et les caractéristiques du matériel sans aucun avis.

Serie 750

Gama modular y puente

Cocinas a gas

750 Series

Modular and counter-top range

Gas cookers



CG-720/M LC



CG-720/M LC
+ S-47



- Remates de chimenea en acero inoxidable.
- Flue shots made of stainless steel.
- Sortie des gazes en en acier inoxydable.
- Topos da chaminé fabricadas em aço inoxidável.







Presión nominal / Working pressure /
Pression de fonctionnement / Presão nominal: 50 mbar.

CG-720/M LC



CG-720/M LC + S-47



						
Dimensiones con embalaje	Packaging dimensions	Dimensions avec emballage	Dimensões da embalagem	(mm)	790 x 450 x 670	790 x 450 x 1.170
Volumen	Volume	Volume	Volume	(m ³)	0.24	0.42
Dimensiones equipo	Equipment dimensions	Dimensions de l'équipement	Dimensões do equipamento	(mm)	400 x 750 x 280	400 x 750 x 900
Quemadores de encimera	Top burners	Brûleurs de dessus	Quem. encimeira	6.50 (kw) 8.00 (kw)	1 1	1 1
Potencia	Power	Puissance	Potência	(kw)	14.50	14.50
Consumos	Consumptions	Consommations	Consumos	GLP Kg/h GN Nm ³ /h	1.13 1.53	1.13 1.53
Peso bruto	Gross weight	Poids brut	Peso bruto	(kg)	57	65
Peso neto	Net weight	Poids net	Peso líquido	(kg)	47	70
Precio	Price	Prix	Preço	(€)	1.020	1.295

Producto con color personalizable / Product with customizable colour / Produit avec couleur personnalisable / Produto para personalizar à cor – Pág. 266
Producto combinable con hornos & soportes / Product to be combined with ovens & supports /
Produit combinable avec fours & soubasements / Produto para combinação com fornos e suportes – Págs. 102-111

REPAGAS, S.A. se reserva el derecho a modificar precios y especificaciones del material sin previo aviso / REPAGAS, S.A. reserves the right to modify prices and change the material specifications without prior notice / REPAGAS, S.A. reserva o direito de alterar preços bem como especificações dos produtos sem aviso prévio / REPAGAS, S.A. se réserve le droit de modifier les prix et les caractéristiques du matériel sans aucun avis.

Série 750

Gamme modulaire et suspendue

Fourneaux à gaz

Série 750

Gama modular e suspensa

Fogões a gás



CG-740/M LC

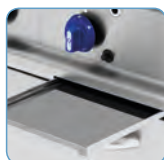

- Bandeja inferior recoge-grasas.
- Lower grease tray.
- Bacs de récupération des graisses.
- Bandeja inferior apara-gordura.



CG-740/M LC
+ S-87







Presión nominal / Working pressure /
Pression de fonctionnement / Presão nominal: 50 mbar.

CG-740/M LC



CG-740/M LC + S-87



						
Dimensiones con embalaje	Packaging dimensions	Dimensions avec emballage	Dimensões da embalagem	(mm)	850 × 770 × 670	850 × 770 × 1.170
Volumen	Volume	Volume	Volume	(m³)	0.44	0.77
Dimensiones equipo	Equipment dimensions	Dimensions de l'équipement	Dimensões do equipamento	(mm)	800 × 750 × 280	800 × 750 × 900
Quemadores de encimera	Top burners	Brûleurs de dessus	Quem. encimeira	6.50 (kw) 8.00 (kw)	2 2	2 2
Potencia	Power	Puissance	Potência	(kw)	29.00	29.00
Consumos	Consumptions	Consommations	Consumos	GLP Kg/h GN Nm³/h	2.26 3.06	2.26 3.06
Peso bruto	Gross weight	Poids brut	Peso bruto	(kg)	85	106
Peso neto	Net weight	Poids net	Peso líquido	(kg)	80	108
Precio	Price	Prix	Preço	(€)	1.586	1.946

Producto con color personalizable / Product with customizable colour / Produit avec couleur personnalisable / Produto para personalizar à cor – Pág. 266
Producto combinable con hornos & soportes / Product to be combined with ovens & supports /
Produit combinable avec fours & soubasements / Produto para combinação com fornos e suportes – Págs. 102-111

REPAGAS, S.A. se reserva el derecho a modificar precios y especificaciones del material sin previo aviso / REPAGAS, S.A. reserves the right to modify prices and change the material specifications without prior notice / REPAGAS, S.A. reserva o direito de alterar preços bem como especificações dos produtos sem aviso prévio / REPAGAS, S.A. se réserve le droit de modifier les prix et les caractéristiques du matériel sans aucun avis.

Serie 750

Gama modular y puente

Cocinas a gas

750 Series

Modular and counter-top range

Gas cookers



CG-741 LC



- Remates de chimenea en acero inoxidable.
- Flue shots made of stainless steel.
- Sortie des gazes en en acier inoxydable.
- Topos da chaminé fabricadas em aço inoxidável.

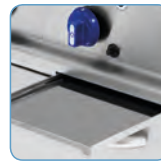

- Bandeja inferior recoge-grasas.
- Lower grease tray.
- Bacs de récupération des graisses.
- Bandeja inferior apara-gordura.



CG-760 LC

Série 750

Gamme modulaire et suspendue

Fourneaux à gaz

Série 750

Gama modular e suspensa

Fogões a gás



Presión nominal / Working pressure /
Pression de fonctionnement / Pressão nominal: 50 mbar.



Dimensiones con embalaje	Packaging dimensions	Dimensions avec emballage	Dimensões da embalagem	(mm)	850 × 800 × 1.160	1.225 × 800 × 1.100	1.225 × 800 × 1.100
Volumen	Volume	Volume	Volume	(m³)	0.79	1.08	1.08
Dimensiones equipo	Equipment dimensions	Dimensions de l'équipement	Dimensões do equipamento	(mm)	800 × 750 × 900	1.205 × 750 × 900	1.205 × 750 × 900
Quemadores de encimera	Top burners	Brûleurs de dessus	Queim. encimeira	6.50 (kw) 8.00 (kw)	2	3	3
Quemadores horno	Oven burners	Brûleurs four	Queimad. forno	7.50 (kw)	1	–	1
Potencia	Power	Puissance	Potência	(kw)	36.50	43.50	51.00
Consumos	Consumptions	Consummations	Consumos	GLP Kg/h	2.84	3.39	3.97
				GN Nm³/h	3.86	4.60	5.39
Peso bruto	Gross weight	Poids brut	Peso bruto	(kg)	173	212	223
Peso neto	Net weight	Poids net	Peso líquido	(kg)	154	148	208
Precio	Price	Prix	Preço	(€)	3.181	2.860	4.170

Producto con color personalizable / Product with customizable colour / Produit avec couleur personnalisable / Produto para personalizar à cor – Pág. 266
Producto combinable con hornos & soportes / Product to be combined with ovens & supports /
Produit combinable avec fours & soubasements / Produto para combinação com fornos e suportes – Págs. 102-111

REPAGAS, S.A. se reserva el derecho a modificar precios y especificaciones del material sin previo aviso / REPAGAS, S.A. reserves the right to modify prices and change the material specifications without prior notice / REPAGAS, S.A. reserva o direito de alterar preços bem como especificações dos produtos sem aviso prévio / REPAGAS, S.A. se réserve le droit de modifier les prix et les caractéristiques du matériel sans aucun avis.

Serie 750

Gama modular y puente

Cocinas a gas

750 Series

Modular and counter-top range

Gas cookers



CG-720/M



CG-720/M
+ S-47



CG-740/M



- Remates de chimenea en hierro fundido.
- Flue shots made of cast iron.
- Sortie des gazes en fonte.
- Topos da chaminé fabricadas em ferro fundido.



Presión nominal / Working pressure /
Pression de fonctionnement / Presão nominal: 50 mbar.



CG-720/M



CG-720/M + S-47



CG-740/M



Dimensiones con embalaje	Packaging dimensions	Dimensions avec emballage	Dimensões da embalagem	(mm)	790 × 450 × 670	790 × 450 × 1.170	850 × 770 × 670
Volumen	Volume	Volume	Volume	(m³)	0.24	0.42	0.44
Dimensiones equipo	Equipment dimensions	Dimensions de l'équipement	Dimensões do equipamento	(mm)	400 × 750 × 280	400 × 750 × 900	800 × 750 × 280
Quem. encimera	Top burners	Brûleurs de dessus	Quem. encimeira	6.50 (kw) 8.00 (kw)	1 1	1 1	2 2
Quem. bajo placa	Burn. under plate	Brûl. sous plaque	Queimad. baixo placa	10.50 (kw)	–	–	–
Quemadores horno	Oven burners	Brûleurs four	Queimad. forno	7.50 (kw)	–	–	–
Potencia	Power	Puissance	Potência	(kw)	14.50	14.50	29.00
Consumos	Consumptions	Consommations	Consumos	GLP Kg/h GN Nm³/h	1.13 1.53	1.13 1.53	2.26 3.06
Peso bruto	Gross weight	Poids brut	Peso bruto	(kg)	57	65	85
Peso neto	Net weight	Poids net	Peso líquido	(kg)	47	64	80
Precio	Price	Prix	Preço	(€)	1.216	1.491	1.975

Producto con color personalizable / Product with customizable colour / Produit avec couleur personnalisable / Produto para personalizar à cor – Pág. 266
Producto combinable con hornos & soportes / Product to be combined with ovens & supports / Produit combinable avec fours & soubasements /
Produto para combinação com fornos e suportes – Págs. 102-111

REPAGAS, S.A. se reserva el derecho a modificar precios y especificaciones del material sin previo aviso / REPAGAS, S.A. reserves the right to modify prices and change the material specifications without prior notice / REPAGAS, S.A. reserva o direito de alterar preços bem como especificações dos produtos sem aviso prévio / REPAGAS, S.A. se réserve le droit de modifier les prix et les caractéristiques du matériel sans aucun avis.

Série 750

Gamme modulaire et suspendue

Fourneaux à gaz

Série 750

Gama modular e suspensa

Fogões a gás



CG-740/M
+ S-87



CG-741



CG-710/RM

200 × 200 × 55 mm / 1 lt.



- Cubetas recoge-grasas individuales.
- Individual grease kegs.
- Bacs individuelles de récupération des graisses.
- Recipiente apara-gorduras individuais.



- Bateas fabricadas en acero inoxidable (gas).
- Top trays made of stainless steel (gas).
- Bacs en acier inoxydable (gaz).
- Tabuleiros fabricados em aço inoxidável (gás).



Presión nominal / Working pressure /
Pression de fonctionnement / Presão nominal: 50 mbar.

CG-740/M + S-87



CG-741



CG-710/RM



Dimensiones con embalaje	Packaging dimensions	Dimensions avec emballage	Dimensões da embalagem	(mm)	850 × 770 × 1.170	850 × 800 × 1.160	850 × 770 × 670
Volumen	Volume	Volume	Volume	(m ³)	0.77	0.79	0.44
Dimensiones equipo	Equipment dimensions	Dimensions de l'équipement	Dimensões do equipamento	(mm)	800 × 750 × 900	800 × 750 × 900	800 × 750 × 280
Quem. encimera	Top burners	Brûleurs de dessus	Quem. encimeira	6.50 (kw) 8.00 (kw)	2 2	2 2	– –
Quem. bajo placa	Burn. under plate	Brûl. sous plaque	Queimad. baixo placa	10.50 (kw)	–	–	1
Quemadores horno	Oven burners	Brûleurs four	Queimad. forno	7.50 (kw)	–	1	–
Potencia	Power	Puissance	Potência	(kw)	29.00	36.50	10.50
Consumos	Consumptions	Consommations	Consumos	GLP Kg/h	2.26	2.84	0.82
				GN Nm ³ /h	3.06	3.86	1.11
Peso bruto	Gross weight	Poids brut	Peso bruto	(kg)	126	173	149
Peso neto	Net weight	Poids net	Peso líquido	(kg)	108	154	120
Precio	Price	Prix	Preço	(€)	2.335	3.570	2.761

Producto con color personalizable / Product with customizable colour / Produit avec couleur personnalisable / Produto para personalizar à cor – Pág. 266
 Producto combinable con hornos & soportes / Product to be combined with ovens & supports / Produit combinable avec fours & soubasements /
 Produto para combinação com fornos e suportes – Págs. 102-111

REPAGAS, S.A. se reserva el derecho a modificar precios y especificaciones del material sin previo aviso / REPAGAS, S.A. reserves the right to modify prices and change the material specifications without prior notice / REPAGAS, S.A. reserva o direito de alterar preços bem como especificações dos produtos sem aviso prévio / REPAGAS, S.A. se réserve le droit de modifier les prix et les caractéristiques du matériel sans aucun avis.

Serie 750

Gama modular y puente

Cocinas a gas

750 Series

Modular and counter-top range

Gas cookers



CG-711/R



- Remates de chimenea en hierro fundido.
- Flue shots made of cast iron.
- Sortie des gazes en fonte.
- Topos da chaminé fabricadas em ferro fundido.

200 x 200 x 55 mm / 1 lt.



- Cubetas recoge-grasas individuales.
- Individual grease kegs.
- Bacs individuelles de récupération des graisses.
- Recipiente apara-gorduras individuais.

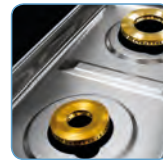

- Bateas fabricadas en acero inoxidable (gas).
- Top trays made of stainless steel (gas).
- Bacs en acier inoxydable (gaz).
- Tabuleiros fabricados em aço inoxidável (gás).



CG-760

Série 750

Gamme modulaire et suspendue

Fourneaux à gaz

Série 750

Gama modular e suspensa

Fogões a gás



CG-761



Presión nominal / Working pressure /
Pression de fonctionnement / Presão nominal: 50 mbar.



Dimensiones con embalaje	Packaging dimensions	Dimensions avec emballage	Dimensões da embalagem	(mm)	850 × 800 × 1.160	1.225 × 800 × 1.100	1.225 × 800 × 1.100
Volumen	Volume	Volume	Volume	(m ³)	0.79	1.08	1.08
Dimensiones equipo	Equipment dimensions	Dimensions de l'équipement	Dimensões do equipamento	(mm)	800 × 750 × 900	1.205 × 750 × 900	1.205 × 750 × 900
Quem. encimera	Top burners	Brûleurs de dessus	Quem. encimeira	6.50 (kw) 8.00 (kw)	–	3 3	3 3
Quem. bajo placa	Burn. under plate	Brûl. sous plaque	Queimad. baixo placa	10.50 (kw)	1	–	–
Quemadores horno	Oven burners	Brûleurs four	Queimad. forno	7.50 (kw)	1	–	1
Potencia	Power	Puissance	Potência	(kw)	18.00	43.50	51.00
Consumos	Consumptions	Consommations	Consumos	GLP Kg/h GN Nm ³ /h	1.40 1.90	3.39 4.60	3.97 5.39
Peso bruto	Gross weight	Poids brut	Peso bruto	(kg)	226	212	223
Peso neto	Net weight	Poids net	Peso líquido	(kg)	196	148	208
Precio	Price	Prix	Preço	(€)	4.356	3.120	4.606

Producto con color personalizable / Product with customizable colour / Produit avec couleur personnalisable / Produto para personalizar à cor – Pág. 266
Producto combinable con hornos & soportes / Product to be combined with ovens & supports / Produit combinable avec fours & soubasements /
Produto para combinação com fornos e suportes – Págs. 102-111

REPAGAS, S.A. se reserva el derecho a modificar precios y especificaciones del material sin previo aviso / REPAGAS, S.A. reserves the right to modify prices and change the material specifications without prior notice / REPAGAS, S.A. reserva o direito de alterar preços bem como especificações dos produtos sem aviso prévio / REPAGAS, S.A. se réserve le droit de modifier les prix et les caractéristiques du matériel sans aucun avis.

Serie 900

Gama modular y puente

Cocinas a gas

900 Series

Modular and counter-top range

Gas cookers



CG-920/M LC



CG-920/M LC + S-49



- Remates de chimenea en acero inoxidable.
- Flue shots made of stainless steel.
- Sortie des gazes en en acier inoxydable.
- Topos da chaminé fabricadas em aço inoxidável.







Presión nominal / Working pressure /
Pression de fonctionnement / Presão nominal: 50 mbar.

CG-920/M LC



CG-920/M LC + S-49



						
Dimensiones con embalaje	Packaging dimensions	Dimensions avec emballage	Dimensões da embalagem	(mm)	940 × 450 × 670	920 × 450 × 1.170
Volumen	Volume	Volume	Volume	(m³)	0.28	0.48
Dimensiones equipo	Equipment dimensions	Dimensions de l'équipement	Dimensões do equipamento	(mm)	400 × 900 × 280	400 × 900 × 900
Quemadores de encimera	Top burners	Brûleurs de dessus	Quem. encimeira	6.50 (kw)	1	1
				8.00 (kw)	1	1
Potencia	Power	Puissance	Potência	(kw)	14.50	14.50
Consumos	Consumptions	Consommations	Consumos	GLP Kg/h	1.12	1.12
				GN Nm³/h	1.54	1.54
Peso bruto	Gross weight	Poids brut	Peso bruto	(kg)	55	81
Peso neto	Net weight	Poids net	Peso líquido	(kg)	50	76
Precio	Price	Prix	Preço	(€)	1.035	1.335

Producto con color personalizable / Product with customizable colour / Produit avec couleur personnalisable / Produto para personalizar à cor – Pág. 266
 Producto combinable con hornos & soportes / Product to be combined with ovens & supports /
 Produit combinable avec fours & soubasements / Produto para combinação com fornos e suportes – Págs. 170-183

REPAGAS, S.A. se reserva el derecho a modificar precios y especificaciones del material sin previo aviso / REPAGAS, S.A. reserves the right to modify prices and change the material specifications without prior notice / REPAGAS, S.A. reserva o direito de alterar preços bem como especificações dos produtos sem aviso prévio / REPAGAS, S.A. se réserve le droit de modifier les prix et les caractéristiques du matériel sans aucun avis.

Star Line

Gama MONOBLOCK



Star Line

MONOBLOCK range



¿Quieres Personalizar Tu Cocina?
¿Quieres Ser Diferente?
¿Quieres Ser Único?



Do You Want To Customize Your Cooker?
Do You Want To Be Different?
Do You Want To Be Unique?

Star Line

Gamme MONOBLOCK

Star Line

Gama MONOBLOCO



Voulez Vous Personnalisez Votre Cuisine?
Voulez Vous Être Different?
Voulez Vous Être Unique?



Queres Personalizar O Teu Fogão?
Queres Ser Diferente?
Queres Ser Único?



Star Line

Gama MONOBLOCK

Bloques de Cocción a Medida

Star Line

MONOBLOCK range

Customized Cooking Line Elements



Star Line son detalles excepcionales para chefs excepcionales, la máxima expresión del fabricado REPAGAS perfectamente ensamblado sobre un plano único de trabajo, una encimera sin igual, carente de juntas ni soldaduras y fabricada en 2 ó 3 mm de espesor a demanda del cliente. Es la consecuencia natural de la estrecha colaboración entre REPAGAS y los cocineros más exigentes, una solución que permite integrar nuestra amplia variedad de productos en un solo bloque fabricado en exclusiva para su propietario lo que le otorga la condición de único e irreplicable. Provisto de cantos redondeados y una altura de encimera de 75 mm.

Star Line are exceptional details for exceptional chefs, the ultimate expression of the REPAGAS manufacture perfectly assembly on a single worktop, a counter-top like no other, without joints or welds and manufactured in 2 or 3 mm thickness to customer demand. It is the natural result of a close collaboration between REPAGAS and most demanding chefs, a solution that integrates our wide range of products in a single block produced exclusively for its owner giving it the status of unique. Provided with rounded edges and a worktop of 75 mm height.

Star Line est faite de détails exceptionnels pour des chefs exceptionnels, avec le dernier design de REPAGAS parfaitement compact sur un seul même plan de travail, un comptoir sans précédent sans joints ni soudures, fabriqué en version de 2 ou 3 mm d'épaisseur à la demande du client. Il est le résultat naturel d'une collaboration étroite entre REPAGAS et des chefs exigeants, une solution qui permet d'intégrer notre grande variété de produits en un seul bloc fabriqué exclusivement lui donnant alors une valeur unique. Équipé avec des bords arrondis et une hauteur wde 75 mm plateau.

Star Line são detalhes excepcionais para chefs excepcionais, a máxima expressão do fabrico REPAGAS, perfeitamente montados sobre um plano de trabalho (tampo) único, um tampo sem igual, não tem juntas nem soldaduras, fabricado com 2 ou 3 mm de espessura, a pedido do cliente. É a consequência natural da estreita colaboração entre Repagas e os cozinheiros mais exigentes. Uma solução que permite integrar a nossa ampla variedade de produtos num bloco único fabricado em exclusivo para o seu proprietário o que lhe confere a condição de único e irrepetível. Provido de cantos boleados e com uma altura de tampo de 75 mm.

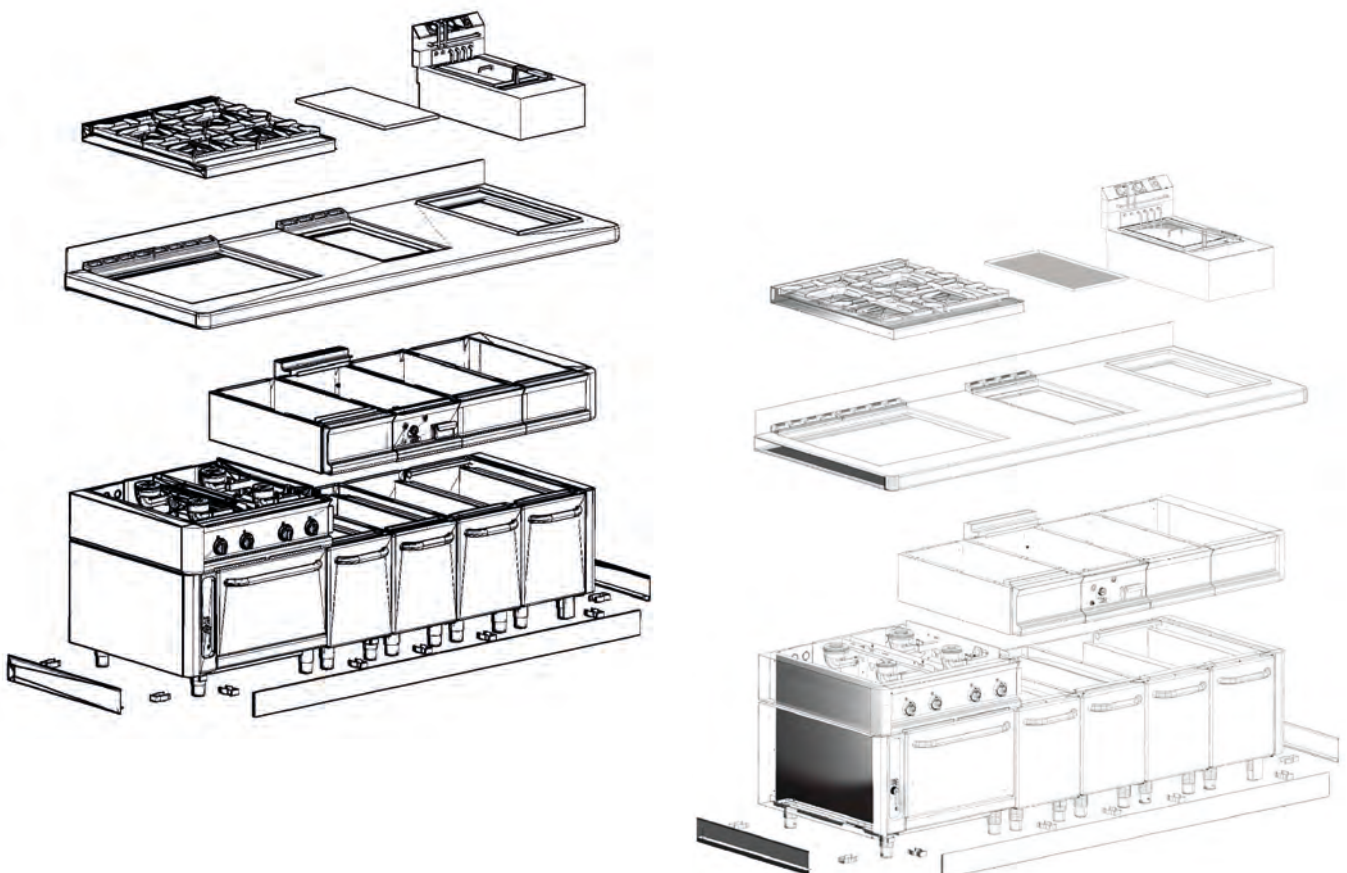



Desarrollo de los diferentes equipos REPAGAS orientado a la elaboración de bloques de cocción a medida. Con la posibilidad de elegir máquinas pertenecientes a dos series diferentes, 750 & 900, y escoger un sistema de apoyo con soporte modular ó suspendido, REPAGAS elabora bloques que combinan diferentes elementos para formar un plano único de trabajo dotado de una encimera de 2 ó 3 mm de espesor fabricada en acero inoxidable, sin juntas, separaciones o uniones y diseñada con un solo propósito: cubrir las necesidades del más exigente de los chefs // Con ello se completa una ya de por sí extensa oferta de productos en el sector de la cocción, con cerca de 300 referencias, sumando al tradicional enfoque de montaje modular una opción completamente diferente a la vez que complementaria con la posibilidad de estar presentes en todos los niveles de hostelería posibles; sin cambiar el funcionamiento de los equipos ni renunciar a ninguna de sus prestaciones, nuestro distribuidor se va encontrar con un bloque de inmejorable presencia, mientras que el usuario final contará con la posibilidad de personalizar y diseñar su propia cocina combinando de entre distintas gamas la maquinaria que considere necesaria.



REPAGAS product development focused on customized cooking lines. Using equipment of two different lines, 750 & 900, and through a modular or counter-top support, REPAGAS makes lay-outs that combine several elements in a single stainless steel work-top of 2 or 3 mm thickness, without joints or gaps and designed with one purpose: to meet the needs of most demanding chefs // With this line REPAGAS completes its wide production range on the cooking sector, with more than 300 references in our portfolio, adding to the traditional modular approach a completely and complementary different option which places us in every level of hospitality and catering market; our dealer will find a cooking line with an unbeatable presence without changes in operation or performances, while the final user will have the chance to customize and design his own cooking line combining equipments from different product series.



Développement de différents appareils de REPAGAS orienté à l'élaboration des blocs de cuisson sur mesure. Avec la possibilité de choisir des machines appartenant à deux différentes séries, 750 & 900, et choisir un système d'appui avec un support modulaire ou suspendu, REPAGAS élabore les blocs qui combinent différents éléments pour former un plan unique de travail doté d'un dessus de 2 ou 3 mm d'épaisseur fabriqué en acier inoxydable, sans jointes, séparations ou unions et conçu uniquement pour couvrir les nécessités du plus exigeant des chefs. // Avec cela, nous complétons une offre étendue de produits du secteur de la cuisson, avec près de 300 références, en ajoutant au traditionnel montage modulaire une option complètement différente et au même temps complémentaire avec la possibilité d'être présents dans tous les niveaux possibles d'hôtellerie; sans changer le fonctionnement des produits ni renoncer à aucune de ses prestations. Notre distributeur pourra compter avec un bloc d'une présence parfaite, alors que l'utilisateur final disposera de la possibilité de personnaliser et de dessiner sa propre cuisine en combinant entre les différentes gammes, les machines qu'il considère nécessaires.



Desenvolvimento dos diferentes Equipamentos REPAGAS orientados a elaboração de blocos de cozinha à medida, com a possibilidade de eleger máquinas pertencentes a duas séries diferentes, 750 & 900, e escolher um sistema de apoio com suporte modular ou suspenso. REPAGAS elabora blocos que combinam diferentes elementos para formar um plano único de trabalho dotado de tampo com 2 ou 3 mm de espessura fabricado em aço inoxidável, sem juntas, separações ou uniões e desenhada com um só propósito: cobrir as necessidades do mais exigentes dos chefs // Com isto se completa uma extensa oferta de produtos no sector da cozinha, com cerca de 300 referências, somando ao tradicional sistema de montagem modular uma opção completamente diferente que nos permite a possibilidade de estar presentes em todos os níveis de hotelaria possíveis sem alterar o funcionamento dos equipamentos nem renunciar a nenhuma das suas prestações. Os nossos distribuidores terá ao dispor um bloco com uma presença distinta, permitindo que o utilizador final disponha da possibilidade de personalizar e desenhar a sua própria cozinha combinado de entre as distintas gamas de máquinas que considere necessário.

Serie 1100

Gama modular

Cocinas a gas

1100 Series

Modular range









Gas cookers



C-1140



Presión nominal / Working pressure / Pression de fonctionnement / Presão nominal: 50 mbar.

 Dimensiones con embalaje	 Packaging dimensions	 Dimensions avec emballage	 Dimensões da embalagem	(mm)	1.005 × 1.345 × 1.050
Volumen	Volume	Volume	Volume	(m ³)	1.42
 Dimensiones equipo	 Equipment dimensions	 Dimensions de l'équipement	 Dimensões do equipamento	(mm)	925 × 1.100 × 850
Quem. de encimera	Top burners	Brûleurs de dessus	Quem. encimeira	6.50 (kw)	1
				8.00 (kw)	1
				10.50 (kw)	2
Quemadores horno	Oven burners	Brûleurs four	Queimadores forno	10.50 (kw)	–
Potencia	Power	Puissance	Potência	(kw)	35.50
Consumos	Consumptions	Consommations	Consumos	GLP Kg/h	2.76
				GN Nm ³ /h	3.75
Peso bruto	Gross weight	Poids brut	Peso bruto	(kg)	202
Peso neto	Net weight	Poids net	Peso líquido	(kg)	150
Precio	Price	Prix	Preço	(€)	3.750

Producto con color personalizable / Product with customizable colour / Produit avec couleur personnalisable / Produto para personalizar à cor – Pág. 266

REPAGAS, S.A. se reserva el derecho a modificar precios y especificaciones del material sin previo aviso / REPAGAS, S.A. reserves the right to modify prices and change the material specifications without prior notice / REPAGAS, S.A. reserva o direito de alterar preços bem como especificações dos produtos sem aviso prévio / REPAGAS, S.A. se réserve le droit de modifier les prix et les caractéristiques du matériel sans aucun avis.

Série 1100

Gamme modulaire

Fourneaux à gaz

Série 1100

Gama modular









Fogões a gás



C-1141



Presión nominal / Working pressure / Pression de fonctionnement / Presão nominal: 50 mbar.

 Dimensiones con embalaje	 Packaging dimensions	 Dimensions avec emballage	 Dimensões da embalagem	(mm)	1.005 × 1.345 × 1.050
Volumen	Volume	Volume	Volume	(m ³)	1.42
 Dimensiones equipo	 Equipment dimensions	 Dimensions de l'équipement	 Dimensões do equipamento	(mm)	925 × 1.100 × 850
Quem. de encimera	Top burners	Brûleurs de dessus	Quem. encimeira	6.50 (kw)	1
				8.00 (kw)	1
				10.50 (kw)	2
Quemadores horno	Oven burners	Brûleurs four	Queimadores forno	10.50 (kw)	1
Potencia	Power	Puissance	Potência	(kw)	46.00
Consumos	Consumptions	Consummations	Consumos	GLP Kg/h	3.58
				GN Nm ³ /h	4.86
Peso bruto	Gross weight	Poids brut	Peso bruto	(kg)	290
Peso neto	Net weight	Poids net	Peso líquido	(kg)	238
Precio	Price	Prix	Preço	(€)	5.095

Producto con color personalizable / Product with customizable colour / Produit avec couleur personnalisable / Produto para personalizar à cor – Pág. 266

REPAGAS, S.A. se reserva el derecho a modificar precios y especificaciones del material sin previo aviso / REPAGAS, S.A. reserves the right to modify prices and change the material specifications without prior notice / REPAGAS, S.A. reserva o direito de alterar preços bem como especificações dos produtos sem aviso prévio / REPAGAS, S.A. se réserve le droit de modifier les prix et les caractéristiques du matériel sans aucun avis.

Série 900

Gamme modulaire et suspendue

Fourneaux à gaz

Série 900

Gama modular e suspensa

Fogões a gás



CG-940/M LC

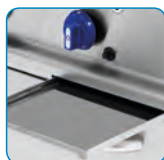

- Bandeja inferior recoge-grasas.
- Lower grease tray.
- Bacs de récupération des graisses.
- Bandeja inferior apara-gordura.



**CG-940/M LC
+ S-89**



Presión nominal / Working pressure /
Pression de fonctionnement / Presão nominal: 50 mbar.

CG-940/M LC



CG-940/M LC + S-89



Dimensiones con embalaje	Packaging dimensions	Dimensions avec emballage	Dimensões da embalagem	(mm)	850 × 920 × 700	940 × 850 × 1.170
Volumen	Volume	Volume	Volume	(m ³)	0.55	0.93
Dimensiones equipo	Equipment dimensions	Dimensions de l'équipement	Dimensões do equipamento	(mm)	800 × 900 × 280	800 × 900 × 900
Quemadores de encimera	Top burners	Brûleurs de dessus	Quem. encimeira	6.50 (kw)	2	2
				8.00 (kw)	2	2
Potencia	Power	Puissance	Potência	(kw)	29.00	29.00
Consumos	Consumptions	Consommations	Consumos	GLP Kg/h	2.24	2.24
				GN Nm ³ /h	3.08	3.08
Peso bruto	Gross weight	Poids brut	Peso bruto	(kg)	95	117
Peso neto	Net weight	Poids net	Peso líquido	(kg)	85	88
Precio	Price	Prix	Preço	(€)	1.600	1.990

Producto con color personalizable / Product with customizable colour / Produit avec couleur personnalisable / Produto para personalizar à cor – Pág. 266
 Producto combinable con hornos & soportes / Product to be combined with ovens & supports /
 Produit combinable avec fours & soubasements / Produto para combinação com fornos e suportes – Págs. 170-183

REPAGAS, S.A. se reserva el derecho a modificar precios y especificaciones del material sin previo aviso / REPAGAS, S.A. reserves the right to modify prices and change the material specifications without prior notice / REPAGAS, S.A. reserva o direito de alterar preços bem como especificações dos produtos sem aviso prévio / REPAGAS, S.A. se réserve le droit de modifier les prix et les caractéristiques du matériel sans aucun avis.

Serie 900

Gama modular y puente

Cocinas a gas

900 Series

Modular and counter-top range

Gas cookers



CG-941 LC



CG-960 LC



- Remates de chimenea en acero inoxidable.
- Flue shots made of stainless steel.
- Sortie des gazes en en acier inoxydable.
- Topos da chaminé fabricadas em aço inoxidável.







Presión nominal / Working pressure /
Pression de fonctionnement / Presão nominal: 50 mbar.

CG-941 LC



CG-960 LC



						
Dimensiones con embalaje	Packaging dimensions	Dimensions avec emballage	Dimensões da embalagem	(mm)	850 × 940 × 1.160	1.270 × 940 × 1.120
Volumen	Volume	Volume	Volume	(m³)	0.93	1.34
Dimensiones equipo	Equipment dimensions	Dimensions de l'équipement	Dimensões do equipamento	(mm)	800 × 900 × 900	1.205 × 900 × 900
Quemadores de encimera	Top burners	Brûleurs de dessus	Quem. encimeira	6.50 (kw)	2	3
				8.00 (kw)	2	3
Quemadores horno	Oven burners	Brûleurs four	Queimad. forno	8.00 (kw)	1	–
Potencia	Power	Puissance	Potência	(kw)	37.00	43.50
Consumos	Consumptions	Consommations	Consumos	GLP Kg/h	2.86	3.63
				GN Nm³/h	3.93	4.62
Peso bruto	Gross weight	Poids brut	Peso bruto	(kg)	193	187
Peso neto	Net weight	Poids net	Peso líquido	(kg)	178	172
Precio	Price	Prix	Preço	(€)	3.253	3.065

Producto con color personalizable / Product with customizable colour / Produit avec couleur personnalisable / Produto para personalizar à cor – Pág. 266
 Producto combinable con hornos & soportes / Product to be combined with ovens & supports /
 Produit combinable avec fours & soubasements / Produto para combinação com fornos e suportes – Págs. 170-183

REPAGAS, S.A. se reserva el derecho a modificar precios y especificaciones del material sin previo aviso / REPAGAS, S.A. reserves the right to modify prices and change the material specifications without prior notice / REPAGAS, S.A. reserva o direito de alterar preços bem como especificações dos produtos sem aviso prévio / REPAGAS, S.A. se réserve le droit de modifier les prix et les caractéristiques du matériel sans aucun avis.

Série 900

Gamme modulaire et suspendue

Fourneaux à gaz

Série 900

Gama modular e suspensa

Fogões a gás



CG-961 LC



CG-961H LC

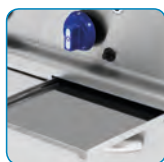

- Bandeja inferior recoge-grasas.
- Lower grease tray.
- Bacs de récupération des graisses.
- Bandeja inferior apara-gordura.



Presión nominal / Working pressure /
Pression de fonctionnement / Presão nominal: 50 mbar.



Dimensiones con embalaje	Packaging dimensions	Dimensions avec emballage	Dimensões da embalagem	(mm)	1.270 × 940 × 1.220	1.270 × 940 × 1.120
Volumen	Volume	Volume	Volume	(m³)	1.34	1.34
Dimensiones equipo	Equipment dimensions	Dimensions de l'équipement	Dimensões do equipamento	(mm)	1.205 × 900 × 900	1.205 × 900 × 900
Quemadores de encimera	Top burners	Brûleurs de dessus	Quem. encimeira	6.50 (kw) 8.00 (kw)	3 3	3 3
Quemadores horno	Oven burners	Brûleurs four	Queimad. forno	8.00 (kw) 14.00 (kw)	1 -	- 1
Potencia	Power	Puissance	Potência	(kw)	51.50	57.50
Consumos	Consumptions	Consommations	Consumos	GLP Kg/h	3.98	4.45
				GN Nm³/h	5.47	6.01
Peso bruto	Gross weight	Poids brut	Peso bruto	(kg)	260	310
Peso neto	Net weight	Poids net	Peso líquido	(kg)	238	266
Precio	Price	Prix	Preço	(€)	4.526	5.072

Producto con color personalizable / Product with customizable colour / Produit avec couleur personnalisable / Produto para personalizar à cor – Pág. 266
Producto combinable con hornos & soportes / Product to be combined with ovens & supports /
Produit combinable avec fours & soubasements / Produto para combinação com fornos e suportes – Págs. 170-183

REPAGAS, S.A. se reserva el derecho a modificar precios y especificaciones del material sin previo aviso / REPAGAS, S.A. reserves the right to modify prices and change the material specifications without prior notice / REPAGAS, S.A. reserva o direito de alterar preços bem como especificações dos produtos sem aviso prévio / REPAGAS, S.A. se réserve le droit de modifier les prix et les caractéristiques du matériel sans aucun avis.

Serie 900

Gama modular y puente

Cocinas a gas y eléctricas

900 Series

Modular and counter-top range

Gas and electric cookers



HPG-26/M



CG-920/M



HPG-26/M
+ S-89



- Remates de chimenea en hierro fundido.
- Flue shots made of cast iron.
- Sortie des gazes en fonte.
- Topos da chaminé fabricadas em ferro fundido.



Presión nominal / Working pressure /
Pression de fonctionnement / Presão nominal: 50 mbar.



Dimensiones con embalaje	Packaging dimensions	Dimensions avec emballage	Dimensões da embalagem	(mm)	920 × 860 × 660	940 × 850 × 1.170	940 × 450 × 670		
Volumen	Volume	Volume	Volume	(m³)	0.52	0.93	0.28		
Dimensiones equipo	Equipment dimensions	Dimensions de l'équipement	Dimensões do equipamento	(mm)	800 × 900 × 280	800 × 900 × 900	400 × 900 × 280		
Quemadores de encimera	Top burners	Brûleurs de dessus	Quem. encimeira	6.50 (kw)	–	–	1		
				7.50 (kw)	1	1	–		
				8.00 (kw)	–	–	1		
				18.50 (kw)	1	1	–		
Potencia	Power	Puissance	Potência	(kw)	26.00	26.00	14.50		
Consumos	Consumptions	Consommations	Consumos	GLP Kg/h	2.06	2.06	1.12		
				GN Nm³/h	2.80	2.80	1.54		
Peso bruto	Gross weight	Poids brut	Peso bruto	(kg)	99	118	55		
Peso neto	Net weight	Poids net	Peso líquido	(kg)	90	110	50		
Precio	Price	Prix	Preço	(€)	2.360	2.660	1.392		

Producto con color personalizable / Product with customizable colour / Produit avec couleur personnalisable / Produto para personalizar à cor – Pág. 266
 Producto combinable con hornos & soportes / Product to be combined with ovens & supports / Produit combinable avec fours & soubasements /
 Produto para combinação com fornos e suportes – Págs. 170-183

REPAGAS, S.A. se reserva el derecho a modificar precios y especificaciones del material sin previo aviso / REPAGAS, S.A. reserves the right to modify prices and change the material specifications without prior notice / REPAGAS, S.A. reserva o direito de alterar preços bem como especificações dos produtos sem aviso prévio / REPAGAS, S.A. se réserve le droit de modifier les prix et les caractéristiques du matériel sans aucun avis.

Série 900

Gamme modulaire et suspendue

Fourneaux à gaz et électriques

Série 900

Gama modular e suspensa

Fogões a gás e elétricas



**CE-920/M
+ S-49**

200 × 200 × 55 mm / 1 lt.



- Cubetas recoge-grasas individuales (gas).
- Individual grease kegs (gas).
- Bacs individuelles de récupération des graisses (gaz).
- Recipiente apara-gorduras individuais (gás).

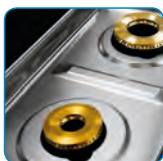

- Bateas fabricadas en acero inoxidable (gas).
- Top trays made of stainless steel (gas).
- Bacs en acier inoxydable (gaz).
- Tabuleiros fabricados em aço inoxidável (gás).



CE-920/M



**CG-920/M
+ S-49**



Presión nominal / Working pressure /
Pression de fonctionnement / Presão nominal: 50 mbar.



Dimensiones con embalaje	Packaging dimensions	Dimensions avec emballage	Dimensões da embalagem	(mm)	940 × 450 × 670	920 × 450 × 1.170	920 × 450 × 1.170
Volumen	Volume	Volume	Volume	(m ³)	0.28	0.48	0.48
Dimensiones equipo	Equipment dimensions	Dimensions de l'équipement	Dimensões do equipamento	(mm)	400 × 900 × 280	400 × 900 × 900	400 × 900 × 900
Quemadores de encimera	Top burners	Brûleurs de dessus	Quem. encimeira	6.50 (kw) 8.00 (kw)	–	1	–
Placas eléctricas	Electric plates	Plaques électriques	Placas elétricas	3.00 (kw) 4.00 (kw)	1	–	1
Potencia	Power	Puissance	Potência	(kw)	7.00	14.50	7.00
Consumos	Consumptions	Consommations	Consumos	GLP Kg/h GN Nm ³ /h	–	1.12 1.54	–
Voltaje	Voltage	Tension	Tensão				
De Serie	Standard	Série	De série	V. / Hz	380 III + N + T 50-60	–	380 III + N + T 50-60
Opcional	Opcional	En option	Opcional	V. / Hz	220 III + T 50-60	–	220 III + T 50-60
Peso bruto	Gross weight	Poids brut	Peso bruto	(kg)	57	85	99
Peso neto	Net weight	Poids net	Peso líquido	(kg)	40	76	90
Precio	Price	Prix	Preço	(€)	2.228	1.692	2.530

Producto con color personalizable / Product with customizable colour / Produit avec couleur personnalisable / Produto para personalizar à cor – Pág. 266
Producto combinable con hornos & soportes / Product to be combined with ovens & supports / Produit combinable avec fours & soubasements /
Produto para combinação com fornos e suportes – Págs. 170-183

REPAGAS, S.A. se reserva el derecho a modificar precios y especificaciones del material sin previo aviso / REPAGAS, S.A. reserves the right to modify prices and change the material specifications without prior notice / REPAGAS, S.A. reserva o direito de alterar preços bem como especificações dos produtos sem aviso prévio / REPAGAS, S.A. se réserve le droit de modifier les prix et les caractéristiques du matériel sans aucun avis.

Serie 900

Gama modular y puente

Cocinas a gas y eléctricas

900 Series

Modular and counter-top range

Gas and electric cookers



CG-940/M



CE-940/M



- Remates de chimenea en hierro fundido.
- Flue shots made of cast iron.
- Sortie des gazes en fonte.
- Topos da chaminé fabricadas em ferro fundido.



CG-940/M + S-89



Presión nominal / Working pressure /
Pression de fonctionnement / Presão nominal: 50 mbar.



Dimensiones con embalaje	Packaging dimensions	Dimensions avec emballage	Dimensões da embalagem	(mm)		850 × 920 × 700	850 × 920 × 700	940 × 850 × 1.170
Volumen	Volume	Volume	Volume	(m ³)		0.55	0.55	0.93
Dimensiones equipo	Equipment dimensions	Dimensions de l'équipement	Dimensões do equipamento	(mm)		800 × 900 × 280	800 × 900 × 280	800 × 900 × 900
Quemadores de encimera	Top burners	Brûleurs de dessus	Quem. encimeira	6.50 (kw) 8.00 (kw)		2 2	– –	2 2
Placas eléctricas	Electric plates	Plaques électriques	Placas elétricas	3.00 (kw) 4.00 (kw)		– –	3 1	– –
Potencia	Power	Puissance	Potência	(kw)		29.00	13.00	29.00
Consumos	Consumptions	Consommations	Consumos	GLP Kg/h GN Nm ³ /h		2.24 3.08	– –	2.24 3.08
Voltaje	Voltage	Tension	Tensão	V. / Hz		–	380 III + N + T 50-60	–
De Serie	Standard	Série	De série	V. / Hz		–	220 III + T 50-60	–
Opcional	Opcional	En option	Opcional					
Peso bruto	Gross weight	Poids brut	Peso bruto	(kg)		95	97	117
Peso neto	Net weight	Poids net	Peso líquido	(kg)		85	90	88
Precio	Price	Prix	Preço	(€)		2.055	3.718	2.445

Producto con color personalizable / Product with customizable colour / Produit avec couleur personnalisable / Produto para personalizar à cor – Pág. 266
Producto combinable con hornos & soportes / Product to be combined with ovens & supports / Produit combinable avec fours & soubasements /
Produto para combinação com fornos e suportes – Págs. 170-183

REPAGAS, S.A. se reserva el derecho a modificar precios y especificaciones del material sin previo aviso / REPAGAS, S.A. reserves the right to modify prices and change the material specifications without prior notice / REPAGAS, S.A. reserva o direito de alterar preços bem como especificações dos produtos sem aviso prévio / REPAGAS, S.A. se réserve le droit de modifier les prix et les caractéristiques du matériel sans aucun avis.

Série 900

Gamme modulaire et suspendue

Fourneaux à gaz et électriques

Série 900

Gama modular e suspensa

Fogões a gás e elétricas



**CE-940/M
+ S-89**

200 × 200 × 55 mm / 1 lt.



- Cubetas recoge-grasas individuales (gas).
- Individual grease kegs (gas).
- Bacs individuelles de récupération des graisses (gaz).
- Recipiente apara-gorduras individuais (gás).



CG-941



- Bateas fabricadas en acero inoxidable (gas).
- Top trays made of stainless steel (gas).
- Bacs en acier inoxydable (gaz).
- Tabuleiros fabricados em aço inoxidável (gás).



CE-941



Presión nominal / Working pressure /
Pression de fonctionnement / Presão nominal: 50 mbar.

CE-940/M + S-89



CG-941



CE-941



Dimensiones con embalaje	Packaging dimensions	Dimensions avec emballage	Dimensões da embalagem	(mm)	940 × 850 × 1.170	850 × 940 × 1.160	850 × 940 × 1.160
Volumen	Volume	Volume	Volume	(m ³)	0.93	0.93	0.93
Dimensiones equipo	Equipment dimensions	Dimensions de l'équipement	Dimensões do equipamento	(mm)	800 × 900 × 900	800 × 900 × 900	800 × 900 × 900
Quemadores de encimera	Top burners	Brûleurs de dessus	Quem. encimeira	6.50 (kw) 8.00 (kw)	–	2 2	–
Placas eléctricas	Electric plates	Plaques électriques	Placas elétricas	3.00 (kw) 4.00 (kw)	3 1	–	3 1
Horno	Oven	Four	Forno	1.50 (kw) 8.00 (kw)	–	– 1	4 –
Potencia	Power	Puissance	Potência	(kw)	13.00	37.00	19.00
Consumos	Consumptions	Consommations	Consumos	GLP Kg/h GN Nm ³ /h	–	2.86 3.93	–
Voltaje	Voltage	Tension	Tensão				
De Serie	Standard	Série	De série	V. / Hz	380 III + N + T 50-60	–	380 III + N + T 50-60
Opcional	Opcional	En option	Opcional	V. / Hz	220 III + T 50-60	–	220 III + T 50-60
Peso bruto	Gross weight	Poids brut	Peso bruto	(kg)	117	193	181
Peso neto	Net weight	Poids net	Peso líquido	(kg)	88	178	178
Precio	Price	Prix	Preço	(€)	4.108	3.708	6.056

Producto con color personalizable / Product with customizable colour / Produit avec couleur personnalisable / Produto para personalizar à cor – Pág. 266
 Producto combinable con hornos & soportes / Product to be combined with ovens & supports / Produit combinable avec fours & sousbassements /
 Produto para combinação com fornos e suportes – Págs. 170-183

REPAGAS, S.A. se reserva el derecho a modificar precios y especificaciones del material sin previo aviso / REPAGAS, S.A. reserves the right to modify prices and change the material specifications without prior notice / REPAGAS, S.A. reserva o direito de alterar preços bem como especificações dos produtos sem aviso prévio / REPAGAS, S.A. se réserve le droit de modifier les prix et les caractéristiques du matériel sans aucun avis.

Serie 900

Gama modular y puente
Cocinas a gas y eléctricas

900 Series

Modular and counter-top range
Gas and electric cookers



CG-910/RM



CG-911/R



CG-960



- Remates de chimenea en hierro fundido.
- Flue shots made of cast iron.
- Sortie des gazes en fonte.
- Topos da chaminé fabricadas em ferro fundido.



Presión nominal / Working pressure /
Pression de fonctionnement / Presão nominal: 50 mbar.



Dimensiones con embalaje	Packaging dimensions	Dimensions avec emballage	Dimensões da embalagem	(mm)		850 × 920 × 650	850 × 940 × 1.160	1.270 × 940 × 1.120
Volumen	Volume	Volume	Volume	(m³)		0.51	0.93	1.34
Dimensiones equipo	Equipment dimensions	Dimensions de l'équipement	Dimensões do equipamento	(mm)		800 × 900 × 280	800 × 900 × 900	1.205 × 900 × 900
Quemadores de encimera	Top burners	Brûleurs de dessus	Quem. encimeira	6.50 (kw)		–	–	3
				8.00 (kw)		–	–	3
Quem. bajo placa	Burn. under plate	Brûl. sous plaque	Quemaid. baixo placa	10.50 (kw)		1	1	–
Potencia	Power	Puissance	Potência	(kw)		10.50	18.50	43.50
Consumos	Consumptions	Consommations	Consumos	GLP Kg/h		0.78	1.44	3.63
				GN Nm³/h		1.11	1.95	4.62
Peso bruto	Gross weight	Poids brut	Peso bruto	(kg)		152	252	187
Peso neto	Net weight	Poids net	Peso líquido	(kg)		140	230	172
Precio	Price	Prix	Preço	(€)		2.756	4.409	3.690

Producto con color personalizable / Product with customizable colour / Produit avec couleur personnalisable / Produto para personalizar a cor – Pág. 266
Producto combinable con hornos & soportes / Product to be combined with ovens & supports / Produit combinable avec fours & soubasements /
Produto para combinação com fornos e suportes – Págs. 170-183

REPAGAS, S.A. se reserva el derecho a modificar precios y especificaciones del material sin previo aviso / REPAGAS, S.A. reserves the right to modify prices and change the material specifications without prior notice / REPAGAS, S.A. reserva o direito de alterar preços bem como especificações dos produtos sem aviso prévio / REPAGAS, S.A. se réserve le droit de modifier les prix et les caractéristiques du matériel sans aucun avis.

Série 900

Gamme modulaire et suspendue

Fourneaux à gaz et électriques

Série 900

Gama modular e suspensa

Fogões a gás e elétricas



CG-961

200 × 200 × 55 mm / 1 lt.



- Cubetas recoge-grasas individuales.
- Individual grease kegs.
- Bacs individuelles de récupération des graisses.
- Recipiente apara-gorduras individuais.

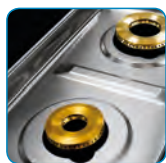

- Bateas fabricadas en acero inoxidable (gas).
- Top trays made of stainless steel (gas).
- Bacs en acier inoxydable (gaz).
- Tabuleiros fabricados em aço inoxidável (gás).



CG-961H



Presión nominal / Working pressure /
Pression de fonctionnement / Presão nominal: 50 mbar.



Dimensiones con embalaje	Packaging dimensions	Dimensions avec emballage	Dimensões da embalagem	(mm)	1.270 × 940 × 1.120	1.270 × 940 × 1.120
Volumen	Volume	Volume	Volume	(m³)	1.34	1.34
Dimensiones equipo	Equipment dimensions	Dimensions de l'équipement	Dimensões do equipamento	(mm)	1.205 × 900 × 900	1.205 × 900 × 900
Quemadores de encimera	Top burners	Brûleurs de dessus	Queim. encimeira	6.50 (kw)	3	3
				8.00 (kw)	3	3
Quemadores horno	Oven burners	Brûleurs four	Queimad. forno	8.00 (kw)	1	–
				14.00 (kw)	–	1
Potencia	Power	Puissance	Potência	(kw)	51.50	57.50
Consumos	Consumptions	Consummations	Consumos	GLP Kg/h	3.98	4.45
				GN Nm³/h	5.47	6.01
Peso bruto	Gross weight	Poids brut	Peso bruto	(kg)	260	310
Peso neto	Net weight	Poids net	Peso líquido	(kg)	238	266
Precio	Price	Prix	Preço	(€)	5.151	5.665

Producto con color personalizable / Product with customizable colour / Produit avec couleur personnalisable / Produto para personalizar à cor – Pág. 266
 Producto combinable con hornos & soportes / Product to be combined with ovens & supports / Produit combinable avec fours & soubasements /
 Produto para combinação com fornos e suportes – Págs. 170-183

REPAGAS, S.A. se reserva el derecho a modificar precios y especificaciones del material sin previo aviso / REPAGAS, S.A. reserves the right to modify prices and change the material specifications without prior notice / REPAGAS, S.A. reserva o direito de alterar preços bem como especificações dos produtos sem aviso prévio / REPAGAS, S.A. se réserve le droit de modifier les prix et les caractéristiques du matériel sans aucun avis.

Cocinas



ENCIMERA



MOD. ENCIMERA
+ HORNO

- Construcción en acero inox
- Parrillas de hierro fundido, desmontables de fácil limpieza
- Encendido electrónico
- Válvula de seguridad
- Patas regulables (h 50 mm)
- 5 quemadores a Gas
- Horno eléctrico a convección + gratinador
- ■ Dotación horno: 2 parrillas G/N 1/1

MODELO	Encimera	Encimera + Horno
Dimensiones	900 x 600 x 200	900 x 600 x 850
Potencia Eléctrica (kw)	--	4,5 (horno)
Potencia Gas (kw)	14,3	14,3
Voltaje (v)	1 x 230	3 x 400 / 1 x 230

	PVP
Encimera	990 €
Encimera + horno	1.925 €



PLUS 600



“New Style”

Diseñada para instalar en espacios reducidos, la serie 600 Plus **New Style** es una línea profesional de cocción de altas prestaciones capaz de garantizar una gran productividad y un rápido servicio.

Una amplia gama de modelos eléctricos y a gas nos garantiza poder cubrir cualquier necesidad



BERTO'S[®]
the best catering equipment



Cocina 3 fuegos + horno T + puerta



Cocinas a gas

- Construcción en acero inox AISI 304
- Sobre y frontal de apoyo en acero inox de 1'5 mm de espesor
- Mandos en fibra de vidrio resistentes al calor, con protección antigrasa.
- Parrillas de fundición.
- Cubeta recoge-liquidos esmaltada.
- Quemadores de hierro fundido garantizados de por vida, muy potentes, de hasta 12 Kw.
- Fuegos abiertos con llama piloto, válvula de seguridad y termopares bimetálicos.
- Horno con cierre estanco en silicona
- Patas de acero inox con altura regulable en 50 mm.
- Hornos a gas GN 1/1 ó Maxi, regulados termostáticamente de 160 a 300 ° C, y guías extraíbles porta bandejas.

ACCESORIOS: Puertas, Planchas, Reductor fuegos, Parrillas hornos, etc.

HIGH POWER

COCINA A GAS 2 FUEGOS

G6F2BH6

1.145 €

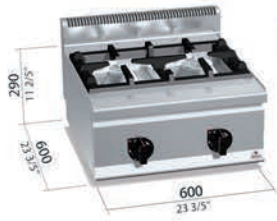

kW 10,5

	kW	10,5
	kcal/h	9.030
	Btu/h	35.826

HIGH POWER

COCINA A GAS 2 FUEGOS + HORNO

G6F2H6+FG1

2.030 €



kW 14

	kW	14		GN 1/1 mm 530x325 x4 pos.
	kcal/h	12.040		
	Btu/h	47.768		

HIGH POWER

COCINA A GAS 3 FUEGOS

G6F3BH12

1.360 €

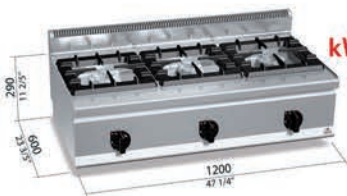

kW 31

			kW	31
			kcal/h	26.660
			Btu/h	105.772

HIGH POWER

COCINA A GAS 3 FUEGOS + HORNO GN 1/1

G6F3H12+FG1

2.174 €

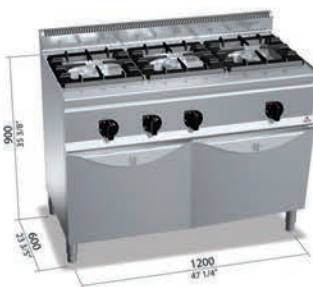

kW 34,5

			kW	34,5		GN 1/1 mm 530x325 x4 pos.
			kcal/h	29.664		
			Btu/h	117.719		

HIGH POWER

COCINA A GAS 3 FUEGOS + HORNO MAXI

G6F3H12+T

2.575 €

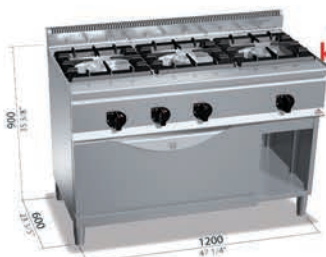

kW 37

			kW	37		mm 830x400x4 pos.
			kcal/h	31.814		
			Btu/h	126.249		



Cocinas a gas

- Construcción en acero inox AISI 304
- Sobre y frontal de apoyo en acero inox de 1'5 mm de espesor
- Mandos en fibra de vidrio resistentes al calor, con protección antigrasa.
- Parrillas de fundición.
- Quemadores de hierro fundido, muy potentes, 3'5 y 6 Kw.
- Fuegos abiertos con llama piloto, válvula de seguridad y termopares bimetálicos.
- Horno con cierre estanco en silicona
- Patas de acero inox con altura regulable en 50 mm.
- Hornos a gas GN 1/1 ó Maxi, regulados termostáticamente de 160 a 300 ° C, y guías extraíbles porta bandejas.

ACCESORIOS: Puertas, Planchas, Reductor fuegos, Parrillas hornos, etc.

ECO POWER

COCINA A GAS 2 FUEGOS SOBREMESA

G6F2BPW

884 €



kW 9,5

	kW	9,5
	kcal/h	8.170
	Btu/h	32.414

ECO POWER

COCINA A GAS 4 FUEGOS SOBREMESA

G6F4BPW

1.410 €



kW 19

		kW	19
		kcal/h	16.340
		Btu/h	64.828

ECO POWER

COCINA A GAS 6 FUEGOS SOBREMESA

G6F6BPW

1.737 €



kW 28,5

			kW	28,5
			kcal/h	24.510
			Btu/h	97.242

ECO POWER

COCINA A GAS 4 FUEGOS + HORNO

G6F4PW+FG1

2.336 €



kW 22,5

		kW	22,5	 GN 1/1 mm 530x325x4 pos.
		kcal/h	19.350	
		Btu/h	76.770	

ECO POWER

COCINA A GAS 4 FUEGOS + HORNO ELECTRICO

G6F4PW+FE1

2.441 €



kW 19+3

		kW	19	 GN 1/1 mm 530x325x4 pos.	 convection
		kcal/h	16.340		
		Btu/h	64.828		

V 230 - 240 ~

ECO POWER

COCINA A GAS 6 FUEGOS + HORNO

G6F6PW+T

2.795 €



kW 34,5

			kW	34,5	 mm 830x400x4 pos.
			kcal/h	29.664	
			Btu/h	117.719	



Cocina 4 fuegos + horno



Cocinas Eléctricas:

- Construcción en acero inox AISI 304
- Sobre y frontal de apoyo en acero inox de 1'5 mm de espesor
- Mandos en fibra de vidrio resistentes al calor, con protección antigrasa
- Placas redondas de 300 mm. en fundición de alto rendimiento térmico, herméticamente fijados a la base monobloc en una sola pieza.
- Resistencias blindadas en acero inox incoloy de 2'6 kw.
- Mando con 7 posiciones, con termostato de trabajo y de seguridad.
- Lámparas testigo de control y funcionamiento.
- Modelo con horno eléctrico GN 1/1
- Patas de acero inox con altura regulable en 50 mm.

ACCESORIOS: Puertas, Voltaje especial, etc.

CLASSIC**COCINA ELECTRICA
2 FUEGOS**

E6P2B

672 €



kW 4



kW 4
V 400 - 415 3N ~

2 kW

CLASSIC**COCINA ELECTRICA
4 FUEGOS**

E6P4B

882 €



kW 8



kW 8
V 400 - 415 3N ~

2 kW

CLASSIC**COCINA ELECTRICA
4 FUEGOS + HORNO**

E6P4+FE1

1.937 €



kW 11



2 kW



GN 1/1
mm 530x325 x4 pos.

**OPCIONAL:****VOLTAJE:**230 - 240 3 **146 €**230 - 240 1 **146 €**

BERTO'S[®]
the best catering equipment

189

ROMAG SA
Maquinaria para hostelería

PLUS 600



Cocina 4 fuegos + horno



Cocinas a gas

- Construcción en acero inox AISI 304
 - Sobre y frontal de apoyo en acero inox de 1'5 mm de espesor
 - Mandos en fibra de vidrio resistentes al calor, con protección antigrasa.
 - Parrillas de fundición.
 - Cubetas recoge-liquidos en acero inox.
 - Quemadores de hierro fundido garantizados de por vida, muy potentes, 3'5 y 7 Kw.
 - Versión Max Power con todos los quemadores de 7 Kw.
 - Fuegos abiertos con llama piloto, válvula de seguridad y termopares bimetálicos.
 - Piezo-eléctrico en horno con cierre estanco en silicona
 - Patas de acero inox con altura regulable en 50 mm.
 - Hornos a gas de 3 tamaños (GN1/1, 2/1 y Maxi) regulados termostáticamente de 160 a 300 ° C, interior en acero inox y guías extraíbles porta bandejas.
- ACCESORIOS:** Puertas, Planchas, Reductor fuegos, Parrillas hornos, etc.

HIGH POWER**COCINA 2 FUEGOS**

G7F2B

1.134 €



kW 10,5

	kW	10,5
	kcal/h	9.030
	Btu/h	35.826

MAX POWER

G7F2P

VERSION POTENCIADA (kW 7 x2) 1.244 €

HIGH POWER**COCINA 2 FUEGOS CON MUEBLE**

G7F2M

1.465 €



kW 10,5

	kW	10,5
	kcal/h	9.030
	Btu/h	35.826

MAX POWER

G7F2MP

Cod. 18701600

VERSION POTENCIADA (kW 7 x2) 1.570 €

HIGH POWER**COCINA 4 FUEGOS**

G7F4B

1.675 €



kW 21

		kW	21
		kcal/h	18.060
		Btu/h	71.652

MAX POWER

G7F4BP

Cod. 18702100

VERSION POTENCIADA (kW 7 x4) 1.827 €

HIGH POWER**COCINA 4 FUEGOS CON MUEBLE**

G7F4M

2.160 €



kW 21

		kW	21
		kcal/h	18.060
		Btu/h	71.652

MAX POWER

G7F4MP

Cod. 18702600

VERSION POTENCIADA (kW 7 x4) 2.315 €

MACROS 700

HIGH POWER**COCINA 6 FUEGOS**

G7F6B

2.194 €



7 kW	3,5 kW	7 kW	kW 31,5 kcal/h 27.090 Btu/h 107.478
3,5 kW	7 kW	3,5 kW	

MAX POWER

G7F6BP

Cod. 18703100

VERSION POTENCIADA (kW 7 x6)

2.315 €

HIGH POWER**COCINA 6 FUEGOS CON MUEBLE**

G7F6M

2.725 €



7 kW	3,5 kW	7 kW	kW 31,5 kcal/h 27.090 Btu/h 107.478
3,5 kW	7 kW	3,5 kW	

MAX POWER

G7F6MP

Cod. 18703600

VERSION POTENCIADA (kW 7 x6)

2.894 €

HIGH POWER**COCINA 4 FUEGOS + HORNO GN 1/1**

G7F4+FG1

2.777 €



7 kW	3,5 kW	kW 25 kcal/h 21.500 Btu/h 85.300
3,5 kW	7 kW	



GN 1/1
mm 530x325x4 pos.
EN
mm 600x400x4 pos.

MAX POWER

G7F4P+FG1

Cod. 18703900

VERSION POTENCIADA (kW 7 x4)

2.861 €

HIGH POWER**COCINA 4 FUEGOS + HORNO GN 2/1**

G7F4+FG

3.090 €



7 kW	3,5 kW	kW 28,8 kcal/h 24.768 Btu/h 98.266
3,5 kW	7 kW	



GN 2/1
mm 530x650x4 pos.

MAX POWER

G7F4P+FG

Cod. 18704100

VERSION POTENCIADA (kW 7 x4)

3.254 €



BERTO'S
the best catering equipment

206

ROMAG SA
Maquinaria para hostelería

HIGH POWER

COCINA 4 FUEGOS + HORNO ELECTRICO GN 1/1

G7F4+FE1

2.959 €



kW 21 +3,5
kcal/h 18.060
Btu/h 71.652



GN 1/1
mm 530x325 x4 pos.
EN
mm 600x400 x4 pos.



HIGH POWER

COCINA 6 FUEGOS + HORNO

G7F6+FG1

3.502 €



kW 35,5
kcal/h 30.530
Btu/h 121.126



GN 1/1
mm 530x325 x4 pos.
EN
mm 600x400 x4 pos.

MAX POWER

G7F6P+FG1

Cod. 18705900

VERSION POTENCIADA (kW 7 x 6) 3.702€

HIGH POWER

COCINA 6 FUEGOS + HORNO GN 2/1

G7F6+FG

3.849 €



kW 39,3
kcal/h 33.798
Btu/h 134.092



GN 2/1
mm 530x650 x4 pos.

MAX POWER

G7F6P+FG

Cod. 18706100

VERSION POTENCIADA (kW 7 x 6) 4.040 €

HIGH POWER

COCINA 6 FUEGOS + HORNO MAXI

G7F6+T

4.588 €



kW 43,5
kcal/h 37.410
Btu/h 148.422



mm 1045x530 x4 pos.

MAX POWER

G7F6P+T

Cod. 18706300

VERSION POTENCIADA (kW 7 x 6) 4.777 €

MACROS 700



Cocinas a gas con placa radiante “Coup de feu”

- Construcción en acero inox AISI 304
- Sobre y frontal de apoyo en acero inox de 1'5 mm de espesor
- Mandos en fibra de vidrio resistentes al calor, con protección antigrasa
- Placa radiante de acero al carbono de gran superficie, con 15 mm. de grosor, con elevada resistencia y distribución homogénea de las altas temperaturas . El potente quemador de hierro fundido de 7 ó 13 Kw. permite alcanzar en poco tiempo la temperatura de 500 °C en el disco central.
- Piezo-eléctrico con cierre estanco en silicona y mandos con protección anti-grasa.
- Con llama piloto, válvula de seguridad y termopares bimetálicos.
- Patas de acero inox con altura regulable en 50 mm.
- Hornos de 3 tamaños (GN 1/1, 2/1 y 3/1) regulados termostáticamente de 160 a 300 ° C, interior en acero inox y guías extraíbles porta bandejas.
- Hornos a gas sin juntas ni guarniciones, puertas estampadas con doble reborde.
- **ACCESORIOS:** Puertas, Planchas, Parrillas horno, Reductor de fuegos, etc.

HIGH POWER**COCINA 2 FUEGOS +
PLACA RADIANTE**

G7T4P2FM

2.774 €



kW 17,5



kW 17,5
kcal/h 15.050
Btu/h 59.710

HIGH POWER**COCINA 2 FUEGOS +
PLACA RADIANTE + HORNO**

G7T4P2F+FG1

3.189 €



kW 21,5



kW 21,5
kcal/h 18.490
Btu/h 73.358



GN 1/1
mm 530x325 x4 pos.
EN
mm 600x400 x4 pos.

HIGH POWER**PLACA RADIANTE +
MUEBLE**

G7TPM

2.249 €



kW 13



kW 13
kcal/h 11.180
Btu/h 44.356

HIGH POWER**PLACA RADIANTE +
HORNO GN 2/1**

G7TP+FG

3.450 €



kW 20,8



kW 20,8
kcal/h 17.888
Btu/h 70.970



GN 2/1
mm 530x650 x4 pos.

HIGH POWER

COCINA 4 FUEGOS + PLACA RADIANTE + MUEBLE

G7T4P4FM

3.598 €



kW 28

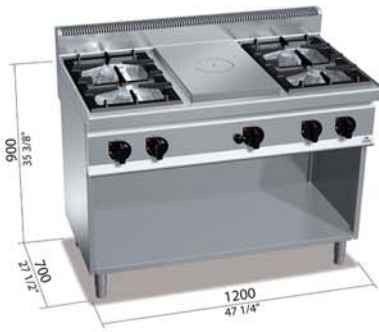

7 kW	7 kW	7 kW	kW	28
3,5 kW	7 kW	3,5 kW	kcal/h	24.080
			Btu/h	95.536

HIGH POWER

COCINA 4 FUEGOS + PLACA RADIANTE + HORNO

G7T4P4F+FG1

4.139 €

kW 32



7 kW	7 kW	7 kW	kW	32	4 kW FG1	GN 1/1 mm 530x325 x4 pos. EN mm 600x400 x4 pos.
3,5 kW	7 kW	3,5 kW	kcal/h	27.620		
			Btu/h	109.184		

HIGH POWER

COCINA 4 FUEGOS + PLACA RADIANTE + HORNO GN2/1

G7T4P4F+FG

4.444 €

kW 35,8



7 kW	7 kW	7 kW	7,8 kW FG	GN 2/1 mm 530x650 x4 pos.
3,5 kW	7 kW	3,5 kW		



Cocina eléctrica + horno



Cocina eléctrica + horno
version MARINE (*)



Cocinas Eléctricas:

- Construcción en acero inox AISI 304
- Sobre y frontal de apoyo en acero inox de 1'5 mm de espesor
- Mandos en fibra de vidrio resistentes al calor, con protección antigrasa
- Placas cuadradas o redondas de 300 mm. en fundición de alto rendimiento térmico, herméticamente fijados a la base monobloc en una sola pieza.
- Resistencias blindadas en acero inox incoloy de 2'6 kw.
- Mando con 7 posiciones, con termostato de trabajo y de seguridad.
- Lámparas testigo de control y funcionamiento.
- Modelos con hornos eléctricos GN 1/1 ó 2/1, posibilidad convección y multifunción.
- Patas de acero inox con altura regulable en 50 mm.

ACCESORIOS: Puertas, Placa hierro colado, Voltaje especial, etc.

* Bajo pedido se puede suministrar en version Marine para barcos con voltaje especial.

HIGH POWER



kW 5,2



COCINA 2 FUEGOS SOBREMESA ELECTRICA



MODELO	POTENCIA	VOLTAJE	P.V.P
E7P2B	5'2 Kw	V 400 3 N	755 €
E7PQ2B	5'2Kw	V 400 3 N	1.190 €

HIGH POWER



kW 5,2



COCINA 2 FUEGOS PIE ELECTRICA



MODELO	POTENCIA	VOLTAJE	P.V.P
E7P2M	5'2 Kw	V 400 3 N	1.102 €
E7PQ2M	5'2Kw	V 400 3 N	1.533 €

HIGH POWER



kW 10,4



COCINA 4 FUEGOS SOBREMESA ELECTRICA



MODELO	POTENCIA	VOLTAJE	P.V.P
E7P4B	10'4Kw	V 400 3 N	1.130 €
E7PQ4B	10'4Kw	V 400 3 N	2.080 €

HIGH POWER



kW 10,4



COCINA 4 FUEGOS PIE ELECTRICA



MODELO	POTENCIA	VOLTAJE	P.V.P
E7P4M	10'4 Kw	V 400 3 N	1.622 €
E7PQ4M	10'4Kw	V 400 3 N	2.473 €

HIGH POWER

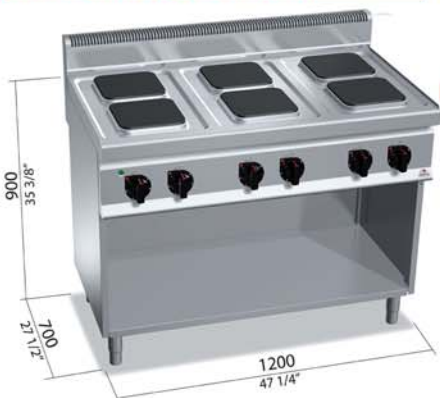

kW 15,6



COCINA 4 FUEGOS PIE ELECTRICA



MODELO	POTENCIA	VOLTAJE	P.V.P
E7P6M	15'6 Kw	V 400 3 N	2.249 €
E7PQ6M	15'6Kw	V 400 3 N	3.778 €

HIGH POWER

COCINA 4 FUEGOS + HORNO ELECTRICO GN 1/1



kW 13,9



MODELO	POTENCIA	VOLTAJE	P.V.P
E7P4+FE1	13'9 Kw	V 400 3 N	2.315 €
E7PQ4+FE1	13'9Kw	V 400 3 N	3.197 €



HIGH POWER

COCINA 4 FUEGOS + HORNO ELECTRICO GN 2/1



kW 17,9



MODELO	POTENCIA	VOLTAJE	P.V.P
E7P4+FE	17'9 Kw	V 400 3 N	3.087 €
E7PQ4+FE	17'9Kw	V 400 3 N	4.111 €



HIGH POWER

COCINA 6 FUEGOS + HORNO ELECTRICO GN 1/1

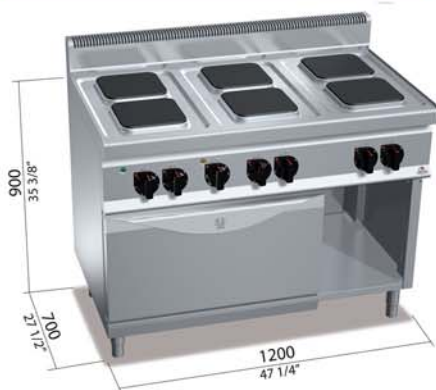

kW 19,1

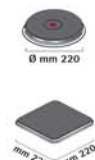

MODELO	POTENCIA	VOLTAJE	P.V.P
E7P6+FE1	19'1 Kw	V 400 3 N	2.948 €
E7PQ6+FE1	19'1Kw	V 400 3 N	4.227 €

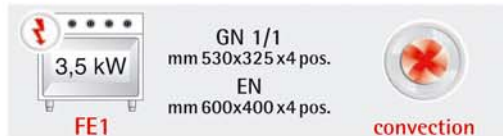

HIGH POWER

COCINA 6 FUEGOS + HORNO ELECTRICO GN 2/1

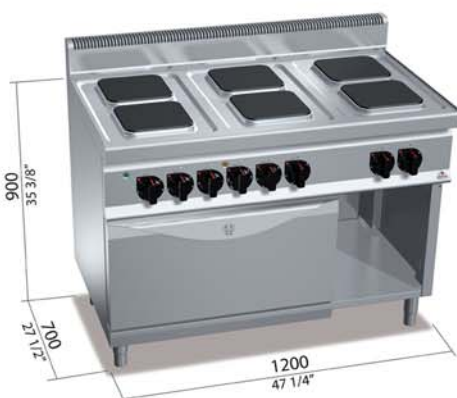

kW 23,1



MODELO	POTENCIA	VOLTAJE	P.V.P
E7P6+FE	23'1 Kw	V 400 3 N	3.614 €
E7PQ6+FE	23'1Kw	V 400 3 N	4.762 €



MACROS 700



cocina vitroceramica + puertas

Cocinas de Vitrocerámica:

- Plano de trabajo vitroceramico de gran espesor
- Mandos en fibra de vidrio resistentes al calor, con protección antigrasa.
- Precisión en la regulación de la temperatura.
- Alcanza en pocos segundos una temperatura de hasta 500 °C.
- Lampara testigo que avisa del calor residual hasta 60 °C.
- Circuito de calentamiento circular de 25 cms de diámetro. Potencia 2'5 kw.
- Las zonas de trabajo están serigrafiadas para un correcto posicionamiento de los recipientes.
- Versión de 2 y 4 zonas de calentamiento.
- Modelo de 4 zonas de calentamiento posibilidad de suministrar con horno electrico de 3'5 ó 7'5 kw.
- Patas de acero inox con altura regulable en 50 mm.
- **ACCESORIOS:** Puertas, etc.

Cocinas de Inducción:

- Construcción en acero inox AISI 304
- Sobre y frontal de apoyo en acero inox de 1'5 mm de espesor
- Mandos en fibra de vidrio resistentes al calor, con protección antigrasa.
- Rapidez de calentamiento.
- Mayor aprovechamiento calorifico.
- Máxima precisión en la regulación de la temperatura.
- Ahorro energetico del 30 %.
- Limpieza muy simple, basta pasar un paño.
- Interrupción automatica inmediata en el momento que se retira el recipiente.
- La zona de calentamiento se autorregula en base al diámetro de la cazuela.
- Modelos de 2 ó 4 zonas de calentamiento de 3'5 kw. cada una.



Cocina inducción + puertas

ECO POWER



kW 5

COCINA 2 FUEGOS VITROCERAMICA

E7P2B/VTR

1.360 €

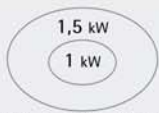
	Ø 250 mm		kW 5	V 400 - 415 3N ~
2,5 kW		1kW+1,5 kW = 2,5 kW		

ECO POWER



kW 10

COCINA 4 FUEGOS VITROCERAMICA

E7P4B/VTR

2.390 €

	Ø 250 mm		kW 10	V 400 - 415 3N ~
2,5 kW		1kW+1,5 kW = 2,5 kW		

ECO POWER





kW 5

COCINA 2 FUEGOS + MUEBLE

E7P2M/VTR

1.680 €

	Ø 250 mm		kW 5	V 400 - 415 3N ~
2,5 kW		1kW+1,5 kW = 2,5 kW		

ECO POWER



kW 10

COCINA 4 FUEGOS + MUEBLE

E7P4M/VTR

2.650 €

	Ø 250 mm		kW 10	V 400 - 415 3N ~
2,5 kW		1kW+1,5 kW = 2,5 kW		

ECO POWER



kW 13,5

COCINA 4 FUEGOS VITROCERAMICA + HORNO GN 1/1

E7P4/VTR+FE1

3.690 €

	Ø 250 mm			GN 1/1 mm 530x325x4 pos. EN mm 600x400x4 pos.	
2,5 kW		1kW+1,5 kW = 2,5 kW	3,5 kW FE1		convection

ECO POWER





kW 17,5

COCINA 4 FUEGOS VITROCERAMICA + HORNO GN 2/1

E7P4/VTR+FE

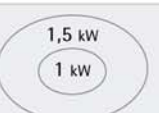
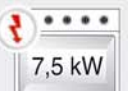
4.295 €

	Ø 250 mm			GN 2/1 mm 530x650x4 pos.	
2,5 kW		1kW+1,5 kW = 2,5 kW	7,5 kW FE		3 kW 4,5 kW multifunction

MACROS 700

POWER INDUCTION

COCINA 2 FUEGOS INDUCCION

E7P2M/IND

5.678 €



7 kW



230 x 230 mm
kW 7

V 400 - 415 3N ~

3,5 kW



POWER INDUCTION

COCINA 4 FUEGOS INDUCCION

E7P4M/IND

10.490 €



14 kW



230 x 230 mm
kW 14

V 400 - 415 3N ~

3,5 kW



POWER INDUCTION

WOK INDUCCION

E7WOK/IND

3.669 €



3,5 kW



Ø 230 mm
kW 3,5

V 400 - 415 3N ~

3,5 kW



BERTO'S[®]
the best catering equipment

238

ROMAG SA
Maquinaria para hostelería



Cocina 6 fuegos + horno MAXI (GN 3/1)



COCINAS A GAS:

- Construcción en acero inox AISI 304
- Sobre y frontal de apoyo en acero inox de 1'5 mm de espesor
- Mandos en fibra de vidrio resistentes al calor, con protección antigrasa
- Parrillas de fundición.
- Cubeta recoge-liquidos en acero inox.
- Quemadores de hierro fundido garantizados de por vida, muy potentes, 3'5 -7 y 12 Kw.
- Fuegos abiertos con llama piloto, válvula de seguridad y termopares bimetálicos.
- Patas de acero inox con altura regulable en 50 mm.
- Hornos a gas de 2 tamaños (GN 2/1 y 3/1) regulados termostáticamente de 160 a 300 ° C, interior en acero inox y guías extraíbles porta bandejas.
- Piezo-eléctrico con cierre estanco en silicona y mandos con protección anti-grasa.
- Hornos con puertas estampadas con doble reborde
- **ACCESORIOS:** Puertas, Planchas, Parrillas horno, Reductor de fuegos, etc.

HIGH-POWER

COCINA A GAS 2 FUEGOS

G9F2M

1.638 €



19 kW



12 kW	kw	19
	Kcal/h	16.340
7 kW	Btu/h	64.828

HIGH-POWER

COCINA A GAS 4 FUEGOS

G9F4M

2.595 €



34,5 kW



12 kW	12 kW	kw	34,5
		Kcal/h	29.670
3,5 kW	7 kW	Btu/h	117.714

HIGH-POWER

COCINA A GAS 6 FUEGOS

G9F6M

3.486 €



53,5 kW



12 kW	12 kW	12 kW	kw	53,5
			Kcal/h	46.010
7 kW	3,5 kW	7 kW	Btu/h	182.542

HIGH-POWER

COCINA A GAS 4 FUEGOS + HORNO

G9F4+FG

3.633 €



42,3 kW



12 kW	12 kW	kw	42,3
		Kcal/h	36.378
3,5 kW	7 kW	Btu/h	144.328



GN 2/1
mm 530x650 x4 pos.

HIGH-POWER

COCINA A GAS 4 FUEGOS + HORNO ELECTRICO

G9F4+FE

4.040 €



42 kW



12 kW	12 kW	kw	42
		Kcal/h	36.300
3,5 kW	7 kW	Btu/h	144.270

V 400 - 3N ~



GN 2/1
mm 530x650 x4 pos.

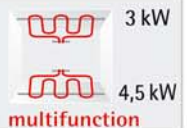

HIGH-POWER

COCINA A GAS 6 FUEGOS + HORNO

G9F6+FG

4.825 €



61,3 kW

12 kW	12 kW	12 kW
7 kW	3,5 kW	7 kW

kw 61,3
Kcal/h 52.718
Btu/h 209.156



GN 2/1
mm 530x650 x4 pos.

HIGH-POWER

COCINA A GAS 6 FUEGOS + HORNO MAXI

G9F6+T

5.286 €



65,5 kW

12 kW	12 kW	12 kW
7 kW	3,5 kW	7 kW

kw 65,5
Kcal/h 56.330
Btu/h 223.486



mm 1045x530 x4 pos.

HIGH-POWER

COCINA A GAS 6 FUEGOS + HORNO ELECTRICO

G9F6+FE

5.296 €



53,5 kW

12 kW	12 kW	12 kW
7 kW	3,5 kW	7 kW

kw 53,5
Kcal/h 46.010
Btu/h 182.542
V 400 - 415 3N ~



GN 2/1
mm 530x650 x4 pos.

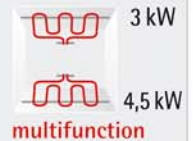

HIGH-POWER

COCINA A GAS 8 FUEGOS + 2 HORNOS

G9F8+2FG

6.846 €



84,6 kW

12 kW	12 kW	12 kW	12 kW
3,5 kW	7 kW	3,5 kW	7 kW

kw 84,6
Kcal/h 72.742
Btu/h 288.667



2x

GN 2/1
mm 530x650 x4 pos.

PAELLERO

PAELLERO

G9P31M

2.950 €



kw 27,2



BERTO'S
the best catering equipment

246

ROMAG SA
Maquinaria para hostelería



Cocina electrica 4 fuegos + horno

Cocinas Eléctricas:

- Construcción en acero inox AISI 304
- Mandos en fibra de vidrio resistentes al calor, con protección antigrasa
- Sobre y frontal de apoyo en acero inox de 1'5 mm de espesor
- Placas cuadradas de 300 mm. en fundición de alto rendimiento térmico, herméticamente fijados a la base monobloc en una sola pieza.
- Resistencias blindadas en acero inox incoloy de 3'5 kw.(Opcional resistencias 4 Kw).
- Mando con 7 posiciones, con termostato de trabajo y de seguridad.
- Lámparas testigo de control y funcionamiento.
- Modelos con hornos eléctricos 2/1, posibilidad convección y multifunción.
- Patas de acero inox con altura regulable en 50 mm.

ACCESORIOS: Puertas, etc.

HIGH-POWER

COCINA ELECTRICA 2 FUEGOS



kW 7

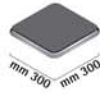

MODELO	POTENCIA	VOLTAJE
E9PQ2M	7 Kw	V 400 3 N

2.162 €

HIGH-POWER

COCINA ELECTRICA 4 FUEGOS



kW 14



MODELO	POTENCIA	VOLTAJE
E9PQ4M	14 Kw	V 400 3 N

3.385 €

HIGH-POWER

COCINA ELECTRICA 6 FUEGOS



kW 21



MODELO	POTENCIA	VOLTAJE
E9PQ6M	21 Kw	V 400 3 N

4.952 €

HIGH-POWER

COCINA ELECTRICA 4 FUEGOS + HORNO



kW 21,5

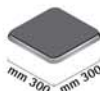

MODELO	POTENCIA	VOLTAJE
E9PQ4+FE	21'5 Kw	V 400 3 N

4.946 €



GN 2/1
mm 530x650 x4 pos.

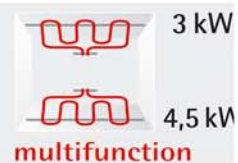

multifunction

HIGH-POWER

COCINA ELECTRICA 6 FUEGOS + HORNO



kW 28,5



MODELO	POTENCIA	VOLTAJE	
E9PQ6+FE	28'5 Kw	V 400 3 N	6.410 €



GN 2/1
mm 530x650 x4 pos.

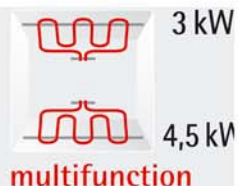

ACCESORIOS COCINAS ELECTRICAS



Puerta 400
139 €



Puerta 600
160 €



2 Puertas 400
274 €



2 Puertas 600
320 €



Plancha lisa
fuego cuadrado
107 €

MAXIMA 900

MAXIMA 900 PLACA RADIANTE "COUP DE FEU"



Cocina radiante + Puertas (OPCIONAL)



Cocinas a gas con placa radiante "Coup de feu"

- Construcción en acero inox AISI 304 -revestimientos laterales-
- Sobre y frontal de apoyo en acero inox de 1'5 mm de espesor
- Mandos en fibra de vidrio resistentes al calor, con protección antigrasa
- Placa radiante de acero al carbono de gran superficie (5.200 cm²) con 15 mm. de grosor con elevada resistencia y distribución homogénea de las altas temperaturas . El potente quemador de hierro fundido de 13 kw. permite alcanzar en poco tiempo la temperatura de 500 °C en el disco central.
- Piezo-eléctrico con cierre estanco en silicona y mandos con protección anti-grasa.
- Con llama piloto, válvula de seguridad y termopares bimetálicos.
- Patas de acero inox con altura regulable en 50 mm.
- Hornos de tamaños (GN 2/1 y Maxi) regulados termostáticamente de 160 a 300 ° C, interior en acero inox y guías extraíbles porta bandejas.
- Hornos a gas, puertas estampadas con doble reborde.
- **ACCESORIOS:** Puertas, Parrillas horno, etc.

HIGH-POWER

PLACA RADIANTE

G9TPM

3.134 €



kW 13

13 kW	kW	6,5+6,5 (13)
	kcal/h	11.180
	Btu/h	44.356

HIGH-POWER

PLACA RADIANTE + HORNO

G9TP+FG

4.226 €



kW 20,8

13 kW	kW	20,08	7,8 kW	GN 2/1 mm 530x650 x4 pos.
	kcal/h	17.888		
	Btu/h	70.970		

HIGH-POWER

PLACA RADIANTE + 2 FUEGOS + HORNO

G9TP2F+FG

5.547 €



kW 39,8

13 kW	12 kW	kW	39,8	7,8 kW	GN 2/1 mm 530x650 x4 pos.		
	7 kW					Kcal/h	34.228
						Btu/h	135.798

HIGH-POWER

PLACA RADIANTE + 4 FUEGOS + HORNO

G9TP4F+FG

7.218 €



kW 58,8

12 kW	13 kW	12 kW	kW	58,8	7,8 kW	GN 2/1 mm 530x650 x4 pos.			
							7 kW	Kcal/h	50.568
								Btu/h	200.626

MAXIMA 900



Cocinas de vitroceramica:

- Plano de trabajo vitroceramico de gran espesor
- Precisión en la regulación de la temperatura.
- Alcanza en pocos segundos una temperatura de hasta 500 ° C.
- Lampara testigo que avisa del calor residual hasta 60 °C.
- Circuito de calentamiento circular de 30 cms de diámetro. Potencia 4 kw.
- Las zonas de trabajo están serigrafiadas para un correcto posicionamiento de los recipientes.
- Versión de 2 y 4 zonas de calentamiento.
- Modelo de 4 zonas de calentamiento posibilidad de suministrar con horno electrico de 3'5 ó 7'5 kw.
- Patas de acero inox con altura regulable en 50 mm.



Cocinas de Inducción:

- Construcción en acero inox AISI 304
- Sobre y frontal de apoyo en acero inox de 1'5 mm de espesor.
- Rapidez de calentamiento.
- Mayor aprovechamiento calorifico.
- Máxima precisión en la regulación de la temperatura.
- Ahorro energetico del 30 %.
- Limpieza muy simple, basta pasar un paño.
- Interrupción automatica inmediata en el momento que se retira el recipiente.
- La zona de calentamiento se autorregula en base al diámetro de la cazuela.
- Modelos de 2 ó 4 zonas de calentamiento de 5 kw. cada una.
- Modelo WOK de 5 kw.
- Patas de acero inox con altura regulable en 50 mm.



VITROCERAMICA

COCINA VITROCERAMICA 2 FUEGOS

E9P2M/VTR

2.293 €



kW 8

4 kW

270 x 270 mm

4 kW

kW 8
V 400 - 415 3N ~



VITROCERAMICA

COCINA VITROCERAMICA 4 FUEGOS

E9P4MP/VTR

3.648 €



kW 16

4 kW
4 kW
4 kW
4 kW

270 x 270 mm

kW 16
V 400 - 415 3N ~



VITROCERAMICA

COCINA VITROCERAMICA + HORNO GN 2/1

E9P4P/VTR+FE

5.105 €



kW 23,5

4 kW
4 kW
4 kW
4 kW

270 x 270 mm

kW 21,1
V 400 - 415 3N ~



GN 2/1
mm 530x650 x4 pos.

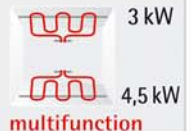

BERTO'S[®]
the best catering equipment

268

ROMAG SA
Maquinaria para hostelería

INDUCCION

COCINA INDUCCION 2 FUEGOS

E9P2M/IND

6.440 €



kW 10

 5 kW	kW 10 V 400 - 415 3N ~
---	---------------------------

5 kW
5 kW

mm 270x270

INDUCCION

COCINA INDUCCION 4 FUEGOS

E9P4M/IND

12.298 €



kW 20

 5 kW	kW 20 V 400 - 415 3N ~
---	---------------------------

5 kW	5 kW
5 kW	5 kW

mm 270x270

INDUCCION

WOK INDUCCION

E9WOK/IND

4.225 €



kW 5

 5 kW	Ø 300 mm kW 5 V 400 - 415 3N ~
---	--------------------------------------

ACCESORIOS VITROCERAMICA E INDUCCION



Puerta 400
139 €



2 Puertas 400
274 €

MAXIMA 900



SG9F2M
1.827 €

COCINA 2 FUEGOS

12 kW
7 kW

Kw 19
Kcal/h 16.340
Btu/h 64.828

SG9F2MP MAX POWER
(2x12 kW = 24 kW)
1.869 €



LXG9F2
1.827 €



SG9F4M
2.956 €

COCINA 4 FUEGOS

12 kW	12 kW
7 kW	3,5 kW

Kw 34'5
Kcal/h 29.670
Btu/h 117.714

SG9F4MP MAX POWER
(4x12 kW = 48 kW)
3.035 €

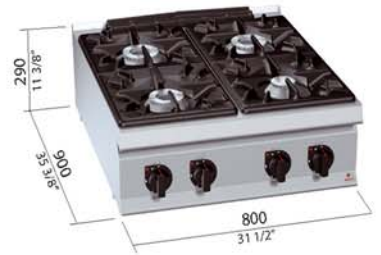

LXG9F4
2.956 €



SG9F6M
3.843 €

COCINA 6 FUEGOS

12 kW	12 kW	12 kW
7 kW	3,5 kW	7 kW

Kw 53'5
Kcal/h 46.010
Btu/h 182.542

SG9F6MP MAX POWER
(6x12 kW = 72 kW)
4.137 €



SG9F4+FG
4.190 €

COCINA 4 FUEGOS + HORNO

12 kW	12 kW
7 kW	3,5 kW

Kw 42'3
Kcal/h 36.378
Btu/h 144.328

SG9F4P+FG MAX POWER
(4x12 kW + 7,8 Kw = 55,8 kW)
4.300 €



GN 2/1
mm 530x650 x4 pos.

COCINA 4 FUEGOS + HORNO GN 2/1



12 kW	12 kW
7 kW	3,5 kW

Kw 34,5
Kcal/h 29.670
Btu/h 117.714



GN 2/1
mm 530x650 x4 pos.

SG9F4+FE
4.610 €

COCINA 6 FUEGOS + HORNO GN 2/1



12 kW	12 kW	12 kW
7 kW	3,5 kW	7 kW

Kw 61,3
Kcal/h 52.718
Btu/h 209.156



GN 2/1
mm 530x650 x4 pos.

SG9F6+FG
5.555 €

SG9F6P+FG MAX POWER
(6x12 kW + 7,8 kW= 79,8 kW)
5.733 €

COCINA 6 FUEGOS + HORNO T



12 kW	12 kW	12 kW
7 kW	3,5 kW	7 kW

Kw 65,5
Kcal/h 56.330
Btu/h 223.486



mm 1045x530 x4 pos.

SG9F6+T
5.775 €

SG9F6P+T MAX POWER
(6x12 kW + 12 kW= 84 kW)
5.884 €

COCINA 6 FUEGOS + HORNO GN 2/1 ELECTRICO



12 kW	12 kW	12 kW
7 kW	3,5 kW	7 kW

Kw 53,5
Kcal/h 46.010
Btu/h 182.542



GN 2/1
mm 530x650 x4 pos.

SG9F6+FE
5.791 €



PLACA RADIANTE

13 kW

Kw 13
Kcal/h 11.180
Btu/h 44.356



SG9TPM
3.396 €

LXG9TP
3.396 €



PLACA RADIANTE + HORNO

13 kW

Kw 20,8
Kcal/h 17.888
Btu/h 70.969



GN 2/1
mm 530x650 x4 pos.

SG9TP+FG
4.947 €



PLACA RADIANTE + 2 FUEGOS

13 kW	12 kW
	7 kW

Kw 32
Kcal/h 27.520
Btu/h 109.184

SG9TP2FM
4.499 €



**PLACA RADIANTE + 2 FUEGOS
HORNO GN 2/1**

13 kW	12 kW
	7 kW

Kw 39,8
Kcal/h 34.228
Btu/h 135.798



GN 2/1
mm 530x650 x4 pos.

SG9TP2F+FG
6.168 €

PLACA RADIANTE ELECTRICA



Kw 14
 Voltaje: 380-415V3N
 4 zonas de cocción

SE9TPM
4.520 €

PLACA RADIANTE ELECTRICA + HORNO



Kw 21'5
 Voltaje: 380-415V3N
 4 zonas de cocción



GN 2/1
 mm 530x650 x4 pos.

SE9TP+FE
5.595 €

COCINA ELECTRICA 2 FUEGOS



4
kW
4
kW

Kw 8
 V 400 - 415 3N

SE9PQ2M
2.348 €



LXE9PQ2
2.348 €

COCINA ELECTRICA 4 FUEGOS



4	4
kW	kW
4	4
kW	kW

Kw 16
 V 400 - 415 3N

SE9PQ4M
3.669 €



LXE9PQ4
3.669 €

COCINA ELECTRICA 6 FUEGOS



SE9PQ6M
5.361 €

4 kW	4 kW	4 kW
4 kW	4 kW	4 kW

Kw 24
V 400 - 415 3N

COCINA 4 FUEGOS + HORNO GN 2/1



SE9PQ4+FE
5.400 €

4 kW	4 kW
4 kW	4 kW

Kw 23
V 400 - 415 3N

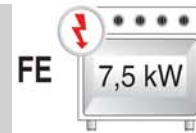

GN 2/1
mm 530x650 x4 pos.

COCINA ELECTRICA 6 FUEGOS + HORNO GN 2/1



SE9PQ6+FE
6.945 €

4 kW	4 kW	4 kW
4 kW	4 kW	4 kW

Kw 31,5
V 400 - 415 3N

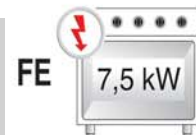

GN 2/1
mm 530x650 x4 pos.



COCINA VITROCERAMICA 2 FUEGOS

4
kW
4
kW

Ø mm 270

Kw 8
V 400 - 415 3N

SE9P2MP/VTR
2.394 €



LXE9P2P/VTR
2.394 €



COCINA VITROCERAMICA 4 FUEGOS

4	4
kW	kW
4	4
kW	kW

Ø mm 270

Kw 16
V 400 - 415 3N

SE9P4MP/VTR
3.833 €



LXE9P4P/VTR
3.833 €



COCINA VITROCERAMICA 4 FUEGOS + HORNO GN 2/1

4	4
kW	kW
4	4
kW	kW

Ø mm 270

Kw 16 + 7,5 kW
V 400 - 415 3N

SE9P4P/VTR+FE
5.368 €



GN 2/1
mm 530x650 x4 pos.



COCINA INDUCCION 2 FUEGOS

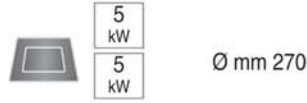

Kw 10
V 400 - 415 3N

SE9P2M/IND
6.650 €



LXE9P2/IND
6.650 €



COCINA INDUCCION 4 FUEGOS

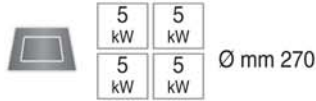

Kw 20
V 400 - 415 3N

SE9P4M/IND
12.790 €

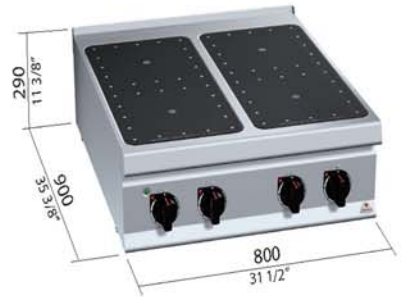

LXE9P4/IND
12.790 €



COCINA INDUCCION WOK



Kw 5
V 400 - 415 3N











SE9WOK/IND
4.347 €



LXE9WOK/IND
4.347 €

Línea 600

SUPERFICIES DE COCCIÓN A GAS GAS STOVE SURFACES

Modelo Model	Dimensiones (L x P x A) Dimensions (W x D x H) mm	Quemadores Burners	Potencia Quemadores Burners Power kW	Potencia Total Total Power kW	Peso Weight kg
PC35G6	350 x 600 x 300		1 x 3 + 1 x 3,6	6,6 	13
PC70G6	700 x 600 x 300		2 x 3 + 2 x 3,6	13,2 	24
PC105G6	1050 x 600 x 300		3 x 3 + 3 x 3,6	19,8 	34
PC5G6	1050 x 600 x 300		2 x 3 + 2 x 3,6 + 1 x 5	18,2 	36
PC5GG6	1050 x 600 x 300		2 x 3 + 2 x 3,6 + 1 x 5	18,2 	58,5

CARACTERÍSTICAS FEATURES

Fuegos abiertos dotados de rejillas de hierro colado esmaltado de gran duración que permiten el apoyo de cacerolas de grandes dimensiones. Superficies de cocción a gas con placa francesa de hierro colado con una temperatura máxima de hasta 450°C.

Open flame gas stove equipped with durable enamelled cast-iron grilles which support large pans











Gas cooking surfaces with French cast-iron hotplate with maximum temperature of up to 450°C



SUPERFICIES COCCIÓN A GAS GAS STOVE SURFACES

REF.	MOD.	P.V.P € / RRP
113001	PC35G6	785
113002	PC70G6	1.225
113003	PC105G6	1.538
113004	PC5G6	1.538
113005	PC5GG6	1.805

SUPERFICIES DE COCCIÓN ELÉCTRICA ELECTRIC STOVE SURFACES





Modelo Model	Dimensiones (L x P x A) Dimensions (W x D x H)	Placas Ø Plates Ø	Potencia Placas Plates Power	Potencia Total Total Power	Tensión/Frecuencia Voltage/Frequency	Peso Weight
	mm	mm	kW	kW	V/Hz	kg
PC35E60 	350 x 600 x 300	180 	2 x 2	4	400-2N 50/60	10,5
PC35E61	350 x 600 x 300	180 	2 x 2	4	230-1 50/60	10,5
PC35E62	350 x 600 x 300	180 	2 x 1,5	3	230-1 50/60	10,5
PC70E60 	700 x 600 x 300	180 	4 x 2	8	400-3N 50/60	19
PC70E62	700 x 600 x 300	180 	4 x 1,5	3 + 3	230-1 50/60	19
PC105E60 	1050 x 600 x 300	180 	6 x 2	12	400-3N 50/60	29
PC105E62	1050 x 600 x 300	180 	6 x 1,5	3 + 6	230-1 50/60	29

CARACTERÍSTICAS FEATURES

Superficies de cocción eléctricas con placas redondas de 180 mm diámetro fijadas herméticamente a la superficie para evitar filtraciones de líquidos.

Electric cooking surfaces with 180 mm diameter round hotplates hermetically sealed to the surface to prevent liquid leakage

SUPERFICIES DE COCCIÓN VITROCERÁMICAS GLASS CERAMIC-HOB STOVE SURFACES

Modelo Model	Dimensiones (L x P x A) Dimensions (W x D x H)	Zona Calentamiento Heating Zone	Potencia Power	Potencia Total Total Power	Tensión/Frecuencia Voltage/Frequency	Peso Weight
	mm		kW	kW	V/Hz	Kg
PCC35E60	350 x 600 x 300		1 x 1,8 + 1 x 2,5	4,3	400-2N 50/60	10,5
PCC35E61	350 x 600 x 300		1 x 1,8 + 1 x 2,5	4,3	230-1 50/60	10,5
PCC70E60 	700 x 600 x 300		2 x 1,8 + 2 x 2,5	8,6	400-3N 50/60	23

CARACTERÍSTICAS FEATURES

Vitrocerámicas de resistencias al infrarrojo de doble superficie de calentamiento.

Dual heating surface ceramic hobs with infrared elements

PCC35E60





























**SUPERFICIES COCCIÓN ELÉCTRICA
ELECTRIC STOVE SURFACES**

REF.	MOD.	P.V.P € / RRP
116001	PC35E60	683
116002	PC35E61	666
116003	PC35E62	649
116004	PC70E60	1.212
116005	PC70E62	1.187
116006	PC105E60	1.529
116007	PC105E62	1.621

**SUPERFICIES COCCIÓN VITROCERÁMICAS
GLASS CERAMIC-HOB STOVE SURFACES**

REF.	MOD.	P.V.P € / RRP
116011	PCC35E60	1.436
116012	PCC35E61	1.417
116013	PCC70E60	2.412

COCINA A GAS + HORNO A GAS GAS STOVE + GAS OVEN

Modelo Model	Dimensiones (L x P x A) Dimensions (W x D x H)	Potencia Quemadores Burners Power	Potencia Horno Oven Power	Capacidad Capacity	Potencia Total Total Power	Tensión/ Frecuencia/ Voltage/ Frequency	Peso Weight
	mm	kW	kW	no./mm	kW	V/Hz	kg
PF70GGG6 	700 x 600 x 850 	2 x 3 + 2 x 3,6	2,2 	4 x (440 x 380)	13,2 0,03 	230-1 50/60	61
PF105GGG6 	1050 x 600 x 850 	3 x 3 + 3 x 3,6	2,2 	4 x (440 x 380)	19,8 0,03 	230-1 50/60	84,5
PFL105GGG6 	1050 x 600 x 850 	3 x 3 + 3 x 3,6	3,3 	4 x GN1/1	19,8 0,03 	230-1 50/60	94
PF5GGG6 	1050 x 600 x 850 	2 x 3 + 2 x 3,6 + 1 x 5	2,2 	4 x (440 x 380)	18,2 0,03 	230-1 50/60	84,5
PFL5GGG6 	1050 x 600 x 850 	2 x 3 + 2 x 3,6 + 1 x 5	3,3 	4 x GN1/1	18,2 0,03 	230-1 50/60	88,5
PPF5GGG6 	1050 x 600 x 850 	2 x 3 + 2 x 3,6 + 1 x 5	2,2 	4 x (440 x 380)	18,2 0,03 	230-1 50/60	106
PPFL5GGG6 	1050 x 600 x 850 	2 x 3 + 2 x 3,6 + 1 x 5	3,3 	4 x GN1/1	18,2 0,03 	230-1 50/60	106

CARACTERÍSTICAS FEATURES

Hornos con puerta de cristal. Existen versiones ventiladas en los hornos. Consultar.
Ovens with glass door. There are fan-assisted versions of the ovens. Enquire

DOTACIÓN STANDARD EQUIPMENT

Una bandeja + una rejilla
One tray + one grille









PPFL5GGG6

**COCINA A GAS + HORNO A GAS
GAS STOVE + GAS OVEN**



















REF.	MOD.	P.V.P € / RRP
113007	PF70GGG6	2.736
113009	PF105GGG6	3.239
113011	PFL105GGG6	3.590
113012	PF5GGG6	3.239
113013	PFL5GGG6	3.590
113014	PPF5GGG6	3.341
113015	PPFL5GGG6	3.687

Línea 700 LC













SUPERFICIES DE COCCIÓN A GAS GAS STOVE SURFACES

Modelo Model	Dimensiones (L x P x A) Dimensions (W x D x H)	Quemadores Burners	Potencia Quemadores Burners Power	Potencia Total Total Power	Peso Weight
	mm		kW	kW	kg
EEC35G7 	350 x 700 x 280		1 x 3 + 1 x 3,6	6,6 	27,5
EEC70G7 	700 x 700 x 280		2 x 3 + 2 x 3,6	13,2 	49
EEC105G7 	1050 x 700 x 280		3 x 3 + 3 x 3,6	19,8 	67,5

COCINA A GAS + HORNO GN2/1 (+ REJILLA) GAS STOVE + OVEN GN2/1 (+ GRILLE)

Modelo Model	Dimensiones (L x P x A) Dimensions (W x D x H)	Potencia Quemadores Burners Power	Potencia Horno Oven Power	Potencia Total Total Power	Tensión/Frecuencia Voltage/Frequency	Peso Weight
	mm	kW	kW	kW	V/Hz	kg
EEF70G7 	700 x 700 x 850 	2 x 3 + 2 x 3,6	7 	20,2 	-	98
EEF70G7 	700 x 700 x 850 	2 x 3 + 2 x 3,6	4,7 	13,2  4,7 	400-3N 50/60	94
EEF105G7 	1050 x 700 x 850 	3 x 3 + 3 x 3,6	7 	26,8 	-	128
EEF105G7 	1050 x 700 x 850 	3 x 3 + 3 x 3,6	4,7 	19,8  4,7 	400-3N 50/60	128

COCINA A GAS + HORNO GN1/1 (+ REJILLA) GAS STOVE + OVEN GN1/1 (+ GRILLE)

Modelo Model	Dimensiones (L x P x A) Dimensions (W x D x H)	Potencia Quemadores Burners Power	Potencia Horno Oven Power	Potencia Total Total Power	Tensión/Frecuencia Voltage/Frequency	Peso Weight
	mm	kW	kW	kW	V/Hz	kg
EEF70GV7 	700 x 700 x 850 	2 x 3 + 2 x 3,6	 5 	13,2  5 	400-3N 50/60	94
EEF105GV7 	1050 x 700 x 850 	3 x 3 + 3 x 3,6	 5 	19,8  5 	400-3N 50/60	128

Hornos Ventilados Convection Ovens 



COCINA A GAS + MÓDULO BAJO GAS STOVE + BELOW UNIT

Modelo Model	Dimensiones (L x P x A) Dimensions (W x D x H)	Quemadores Burners	Potencia Quemadores Burners Power	Potencia Total Total Power	Peso Weight
	mm		kW	kW	kg
EEC35FG7	350 x 700 x 850		1 x 3 + 1 x 3,6	6,6	27
EEC70FG7	700 x 700 x 850		2 x 3 + 2 x 3,6	13,2	49
EEC105FG7	1050 x 700 x 850		3 x 3 + 3 x 3,6	19,8	67,5

ACCESORIOS LÍNEA 700 LC 700 LC LINE ACCESSORIES

REF.	DENOMINACIÓN NAME	P.V.P € / RRP
619001	PUERTA IZQUIERDA / DERECHA LEFT / RIGHT DOOR	151,00
220585	ELEMENTO DE UNIÓN CONNECTING ELEMENT	31,00
120640	PLACA LISA HIERRO COLADO 2 FUEGOS. Dimensiones: 510 x 310 mm 2 FLAME SMOOTH CAST IRON PLATE. Dimensions: 510 x 310 mm	189,00
120645	PLACA RAYADA HIERRO COLADO 2 FUEGOS. Dimensiones: 510 x 310 mm 2 FLAME GROOVED CAST IRON PLATE. Dimensions: 510 x 310 mm	244,00

**SUPERFICIES COCCIÓN A GAS
GAS STOVE SURFACES**

REF.	MOD.	P.V.P € / RRP
613064	EEC35G7	879
613065	EEC70G7	1.362
613066	EEC105G7	1.742

**SUPERFICIES COCCIÓN A GAS+HORNO GN2/1
GAS STOVE SURFACES + OVEN GN2/1**

REF.	MOD.	P.V.P € / RRP
613070	EEF70GG7	2.854
613072	EEF70G7	3.040
613071	EEF105GG7	3.619
613073	EEF105G7	3.741

**SUPERFICIES COCCIÓN A GAS+HORNO GN1/1
GAS STOVE SURFACES + OVEN GN1/1**











REF.	MOD.	P.V.P € / RRP
613074	EEF70GV7	3.229
613075	EEF105GV7	3.927

**SUPERFICIES COCCIÓN A GAS+MÓDULO BAJO
GAS STOVE SURFACES + BELOW UNIT**

REF.	MOD.	P.V.P € / RRP
613067	EEC35FG7	1.204
613068	EEC70FG7	1.712
613069	EEC105FG7	2.120

Línea 700 Basic

SUPERFICIES DE COCCIÓN A GAS BASIC BASIC GAS STOVE SURFACES

Modelo Model	Dimensiones (L x P x A) Dimensions (W x D x H)	Quemadores Burners	Potencia Quemadores Burners Power	Potencia Total Total Power	Peso Weight
	mm		kW	kW	kg
EC35G7	350 x 700 x 280		1 x 6 + 1 x 3,5	9,6 	27,5
EC35SG7	350 x 700 x 280		2 x 6	12 	27,5
EC70G7	700 x 700 x 280		2 x 6 + 2 x 3,5	19 	49
EC70SG7	700 x 700 x 280		4 x 6	24 	49
EC105G7	1050 x 700 x 280		4 x 6 + 2 x 3,5	31 	67,5

EC70SG7



SUPERFICIES COCCIÓN A GAS BASIC BASIC GAS STOVE SURFACES

REF.	MOD.	P.V.P € / RRP
613042	EC35G7	1.035
613043	EC35SG7	1.060
613044	EC70G7	1.580
613045	EC70SG7	1.635
613046	EC105G7	2.150

COCINA A GAS + HORNO GN2/1 (+ REJILLA) BASIC GAS STOVE + OVEN GN2/1 (+ GRILLE)

Modelo Model	Dimensiones (L x P x A) Dimensions (W x D x H)	Potencia Quemadores Burners Power	Potencia Horno Oven Power	Potencia Total Total Power	Tensión/Frecuencia Voltage/Frequency	Peso Weight
	mm	kW	kW	kW	V/Hz	kg
EF70GG7	700 x 700 x 850	2 x 6 + 2 x 3,5	7	26	-	98
EF70SGG7	700 x 700 x 850	4 x 6	7	31	-	98
EF70G7	700 x 700 x 850	2 x 6 + 2 x 3,5	4,7	19 4,7	400-3N 50/60	94
EF70SG7	700 x 700 x 850	4 x 6	4,7	24 4,7	400-3N 50/60	94
EF105GG7	1050 x 700 x 850	4 x 6 + 2 x 3,5	7	38	-	128
EF105G7	1050 x 700 x 850	4 x 6 + 2 x 3,5	4,7	31 4,7	400-3N 50/60	128















EF70GG7

**COCINA A GAS BASIC + HORNO GN2/1
BASIC GAS STOVE + OVEN GN2/1**













REF.	MOD.	P.V.P € / RRP
613052	EF70GG7	3.080
613053	EF70SGG7	3.130
613055	EF70G7	3.280
613056	EF70SG7	3.330
613054	EF105GG7	3.940
613057	EF105G7	4.003

Línea 700 Basic

COCINA A GAS BASIC + HORNO VENTILADO (+ REJILLA) BASIC GAS STOVE + CONVECTION OVEN (+ GRILLE)

Modelo Model	Dimensiones (L x P x A) Dimensions (W x D x H)	Potencia Quemadores Burners Power	Potencia Hornos Oven Power	Potencia Total Total Power	Tensión/Frecuencia Voltage/Frequency	Peso Weight
	mm	kW	kW	kW	V/Hz	kg
EF70GV7	700 x 700 x 120 	2 x 6 + 2 x 3,5 	5 	19  5 	400-3N 50/60	94
EF70SGV7	700 x 700 x 850 	4 x 6 	5 	24  5 	400-3N 50/60	94
EF105GV7	1050 x 700 x 850 	4 x 6 + 2 x 3,5 	5 	31  5 	400-3N 50/60	128

COCINA A GAS BASIC + HORNO FULLSIZE (+ REJILLA) BASIC GAS STOVE + FULLSIZE OVEN (+ GRILLE)

Modelo Model	Dimensiones (L x P x A) Dimensions (W x D x H)	Potencia Quemadores Burners Power	Potencia Hornos Oven Power	Potencia Total Total Power	Tensión/Frecuencia Voltage/Frequency	Peso Weight
	mm	kW	kW	kW	V/Hz	kg
EFX105GGE7*	1050 x 700 x 120 	4 x 6 + 2 x 3,5	7  3 	31 	230-1 50/60	128
EFX105G7	1050 x 700 x 850 	4 x 6 + 2 x 3,5	6,3 	31  6,3 	400-3N 50/60	128
EFX105GV7	1050 x 700 x 850 	4 x 6 + 2 x 3,5 	5 	31  5 	400-3N 50/60	128

Hornos Ventilados Convection Ovens 

*Modelo EFX105GGE7 con grill eléctrico *EFX105GGE7 model with electric grill

EFX105G7



COCINA A GAS BASIC + HORNO VENTILADO GN1/1 BASIC GAS STOVE + CONVECTION OVEN GN1/1

REF.	MOD.	P.V.P € / RRP
613060	EF70GV7	3.470
613061	EF70SGV7	3.525
613062	EF105GV7	4.195

COCINA A GAS BASIC + HORNO FULLSIZE BASIC GAS STOVE + FULLSIZE OVEN

REF.	MOD.	P.V.P € / RRP
613058	EFX105GGE7	4.362
613059	EFX105G7	4.449
613063	EFX105GV7	4.703

COCINA A GAS BASIC + MÓDULO BAJO BASIC GAS STOVE + BELOW UNIT



















Modelo Model	Dimensiones (L x P x A) Dimensions (W x D x H)	Quemadores Burners	Potencia Quemadores Burners Power	Potencia Total Total Power	Peso Weight
	mm		kW	kW	kg
EC35FG7	350 x 700 x 120		1 x 6 + 1 x 3,5	9,6	27,5
EC35FSG7	350 x 700 x 850		2 x 6	12	27,5
EC70FG7	700 x 700 x 850		2 x 6 + 2 x 3,5	19	49
EC70FSG7	700 x 700 x 850		4 x 6	24	49
EC105FG7	1050 x 700 x 850		4 x 6 + 2 x 3,5	31	67,5

**COCINA A GAS BASIC + MÓDULO BAJO
BASIC GAS STOVE + BELOW UNIT**

REF.	MOD.	P.V.P € / RRP
613047	EC35FG7	1.370
613048	EC35FSG7	1.395
613049	EC70FG7	1.945
613050	EC70FSG7	2.000
613051	EC105FG7	2.540

Línea 700

SUPERFICIES DE COCCIÓN A GAS GAS STOVE SURFACES

Modelo Model	Dimensiones (L x P x A) Dimensions (W x D x H)	Quemadores Burners	Potencia Quemadores Burners Power	Potencia Total Total Power	Peso Weight
	mm		kW	kW	kg
PC35G7 	350 x 700 x 280		1 x 7,2 + 1 x 3,3	10,5 	27,7
PC70G7 	700 x 700 x 280		1 x 7,2 + 1 x 3,3 + 2 x 4,5	19,5 	49
PC105G7 	1050 x 700 x 280		2 x 7,2 + 2 x 3,3 + 2 x 4,5	30 	67,5
PCP70G7 	700 x 700 x 280		1 x 7,2 + 1 x 3,3 + 1 x 4,5	15 	61
PCP105G7 	1050 x 700 x 280		1 x 7,2 + 2 x 3,3 + 2 x 4,5	22,8 	84,5
PPC70G7 	700 x 700 x 280		1 x 9	9 	66

CARACTERÍSTICAS FEATURES

Quemadores a gas en hierro fundido esmaltado y vitrificado con doble corona y llama estabilizada.

Termopar de seguridad para evitar escapes de gas accidentales.

Bordes antirrebosamiento de líquidos.

Amplios canales de goteo.

Pueden funcionar con gas natural o licuado.

Enamelled and vitrified cast-iron gas burners with double crown and stabilised flame

Safety thermocouple to prevent accidental gas leakage

Liquid overflow prevention edges

Wide drip channels

They can work with natural or liquefied gas

PCP70G7

































PC70G7



SUPERFICIES COCCIÓN A GAS GAS STOVE SURFACES

REF.	MOD.	P.V.P € / RRP
613001	PC35G7	1.091
613002	PC70G7	1.671
613003	PC105G7	2.271
613004	PCP70G7	2.106
613005	PCP105G7	2.708
613006	PPC70G7	2.020

COCINA A GAS + HORNO GN2/1 (+ REJILLA) GAS STOVE + OVEN GN2/1 (+ GRILLE)







Modelo Model	Dimensiones (L x P x A) Dimensions (W x D x H)	Potencia Quemadores Burners Power	Potencia Horno Oven Power	Potencia Total Total Power	Tensión/Frecuencia Voltage/Frequency	Peso Weight
	mm	kW	kW	kW	V/Hz	kg
PF70G7 	700 x 700 x 850 	1 x 7,2 + 1 x 3,3 + 2 x 4,5	4,7 	19,5  4,7 	400-3N 50/60	94
PF70V7	HORNO VENTILADO GN1/1 CONVECTION OVEN GN1/1 					
PF70GG7 	700 x 700 x 850 	1 x 7,2 + 1 x 3,3 + 2 x 4,5	7 	26,5 	-	98
PF70GG7 	700 x 700 x 850 	1 x 7,2 + 1 x 3,3 + 1 x 4,5	7 	22 	-	113
PPF70GG7 	700 x 700 x 850 	1 x 9	7 	16 	-	121
PF105G7 	1050 x 700 x 850 	2 x 7,2 + 2 x 3,3 + 2 x 4,5	4,7 	30  4,7 	400 3N 50/60	126
PF105V7	HORNO VENTILADO GN1/1 CONVECTION OVEN GN1/1 					
PF105GG7 	1050 x 700 x 850 	2 x 7,2 + 2 x 3,3 + 2 x 4,5	7 	37 	-	128
PPF105GG7 	1050 x 700 x 850 	1 x 7,2 + 2 x 3,3 + 2 x 4,5	7 	29,8 	-	142

**COCINA A GAS + HORNO GN2/1
GAS STOVE + OVEN GN2/1**















REF.	MOD.	P.V.P € / RRP
613007	PF70G7	3.461
613011	PF70GG7	3.249
613012	PF70GG7	3.749
613013	PPF70GG7	3.392
613008	PF105G7	4.304
613014	PF105GG7	4.167
613015	PPF105GG7	4.610

Línea 700

COCINA A GAS + MÓDULO BAJO GAS STOVE + BELOW UNIT

Modelo Model	Dimensiones (L x P x A) Dimensions (W x D x H)	Quemadores Burners	Potencia Quemadores Burners Power	Potencia Total Total Power	Peso Weight
	mm		kW	kW	kg
PC70G7A 	700 x 700 x 850		1 x 7,2 + 1 x 3,3 + 2 x 4,5	19,5 	61
PC105G7A 	1050 x 700 x 850		2 x 7,2 + 2 x 3,3 + 2 x 4,5	30 	80

COCINA A GAS + HORNO FULLSIZE (+REJILLA) GAS STOVE + FULLSIZE OVEN (+ GRILLE)

Modelo Model	Dimensiones (L x P x A) Dimensions (W x D x H)	Potencia Quemadores Burners Power	Potencia Horno Oven Power	Potencia Total Total Power	Tensión/Frecuencia Voltage/Frequency	Peso Weight
	mm	kW	kW	kW	V/Hz	kg
PFX105GG7 	1050 x 700 x 850 	2 x 7,2 + 2 x 3,3 + 2 x 4,5	7 	37 	-	128
PFX105GGE7 	1050 x 700 x 850 	2 x 7,2 + 2 x 3,3 + 2 x 4,5	7  3 	37  3 	230-1 50/60	132
PFX105G7 	1050 x 700 x 850 	2 x 7,2 + 2 x 3,3 + 2 x 4,5	6,3 	30  6,3 	400-3N 50/60	128

PFX105V7

HORNO VENTILADO GNI/1 CONVECTION OVEN GNI/1 

CARACTERÍSTICAS FEATURES

Ideales para cocción de alimentos de gran tamaño.

Dimensiones interiores: 880 x 620 x 300/400 mm

Modelo PFX105GGE7 con grill eléctrico.

Ideal for cooking large pieces of food

Inner dimensions: 880 x 620 x 300/400 mm

PFX105GGE7 model with electric grill

COCINAS A GAS + MÓDULO BAJO GAS STOVE + BELOW UNIT

REF.	MOD.	P.V.P € / RRP
613036	PC70G7A	2.004
613037	PC105G7A	2.642

COCINAS A GAS + HORNO FULLSIZE GAS STOVE + FULLSIZE OVEN

REF.	MOD.	P.V.P € / RRP
613016	PFX105GG7	4.462
613009	PFX105GGE7	4.697
613010	PFX105G7	4.697

HORNOS VENTILADOS CONVECTION OVENS 

CONSULTAR PRECIOS CHECK PRICE LIST

SUPERFICIES DE COCCIÓN ELÉCTRICAS ELECTRIC STOVE SURFACES

Modelo Model	Dimensiones (L x P x A) Dimensions (W x D x H)	Dimensiones Placas Plate Dimensions	Potencia Quemadores Burners Power	Potencia Total Total Power	Tensión/Frecuencia Voltage/Frequency	Peso Weight
	mm	mm ø	kW	kW	V/Hz	kg
PCR35E7	350 x 700 x 280	220	2 x 2,6	5,2	400-3N 50/60	15,5
PCR70E7		700 x 700 x 280	3 x 2,6 + 1 x 1,5	9,3	400-3N 50/60	25
PCR70E7I		700 x 700 x 280	4 x 2,6	10,4	400-3N 50/60	25
PCR105E7	1050 x 700 x 280	220	6 x 2,6	15,6	400-3N 50/60	37
PCS35E7	350 x 700 x 280	220 x 220	2 x 2,6	5,2	400-3N 50/60	21
PCS70E7		700 x 700 x 280	4 x 2,6	10,4	400-3N 50/60	35
PCS105E7		1050 x 700 x 280	6 x 2,6	15,6	400-3N 50/60	50,5

CARACTERÍSTICAS FEATURES

Placas provistas de termostato que reduce automáticamente la potencia erogada al retirar el recipiente colocado sobre ellas.
Plates equipped with a thermostat that automatically reduces the power delivered when removing the cookware from them.

PCR105E7





PCS70E7

**SUPERFICIES COCCIÓN ELÉCTRICAS
ELECTRIC STOVE SURFACES**

REF.	MOD.	P.V.P € / RRP
616004	PCR35E7	942
616005	PCR70E7	1.403
616006	PCR70E7I	1.403
616007	PCR105E7	1.913
616008	PCS35E7	1.410
616009	PCS70E7	2.415
616010	PCS105E7	3.713

Línea 700

SUPERFICIES DE COCCIÓN VITROCERÁMICAS GLASS CERAMIC-HOB STOVE SURFACES

Modelo Model	Dimensiones (L x P x A) Dimensions (W x D x H)	Zona Calentamiento Heating Zone	Potencia Zona Zone Power	Potencia Total Total Power	Tensión/Frecuencia Voltage/Frequency	Peso Weight
	mm		kW	kW	V/Hz	kg
PCC35E7	350 x 700 x 280		1 x 1,8 + 1 x 2,5	4,3 	400-3N 50/60	14
PCC70E7 	700 x 700 x 280		2 x 1,8 + 2 x 2,5	8,6 	400-3N 50/60	22

CARACTERÍSTICAS FEATURES





Placas vitrocerámicas estancas.

Calentamiento mediante resistencias circulares al infrarrojo bajo una placa vitrocerámica hermética y lisa, fácil de limpiar y sin peligro de filtraciones de líquidos. Indicadores luminosos avisan del calor residual presente en la placa.

Sealed glass-ceramic hobs.

Heating by circular infrared elements under a hermetic and smooth ceramic hob, easy to clean and with no danger of leakage of liquids. Light indicators warn of the residual heat still present on the hob.

SUPERFICIES DE COCCIÓN POR INDUCCIÓN INDUCTION STOVE SURFACES

Modelo Model	Dimensiones (L x P x A) Dimensions (W x D x H)	Zona Calentamiento Heating Zone	Potencia Zona Zone Power	Potencia Total Total Power	Tensión/Frecuencia Voltage/Frequency	Peso Weight
	mm		kW	kW	V/Hz	kg
PIN35E7	350 x 700 x 280		2 x 3,5	7 	400-3N 50/60	14
PIN70E7 	700 x 700 x 280		4 x 3,5	14	400-3N 50/60	22

PIN70E7



PIN35E7



SUPERFICIES COCCIÓN VITROCERÁMICAS GLASS CERAMIC-HOB STOVE SURFACES

REF.	MOD.	P.V.P € / RRP
616001	PCC35E7	2.028
616002	PCC70E7	3.524

SUPERFICIES COCCIÓN POR INDUCCIÓN INDUCTION STOVE SURFACES

REF.	MOD.	P.V.P € / RRP
616011	PIN35E7	6.670
616012	PIN70E7	13.100

SUPERFICIES DE COCCIÓN ELÉCTRICAS DE PLANCHA GRILL ELECTRIC STOVE SURFACES

Modelo Model	Dimensiones (L x P x A) Dimensions (W x D x H)	Zona Calentamiento Heating Zone	Potencia Zona Zone Power	Potencia Total Total Power	Tensión/Frecuencia Voltage/Frequency	Peso Weight
	mm		kW	kW	V/Hz	kg
PP70E7	700 x 700 x 280		4 x 2	8	400-3N 50/60	69

SUPERFICIES DE COCCIÓN ELÉCTRICAS DE PLANCHA + HORNO GN2/1 GRILL ELECTRIC STOVE SURFACES + OVEN GN2/1

Modelo Model	Dimensiones (L x P x A) Dimensions (W x D x H)	Potencia Quemadores Burners Power	Potencia Horno Oven Power	Potencia Total Total Power	Tensión/Frecuencia Voltage/Frequency	Peso Weight
	mm	kW	kW	kW	V/Hz	kg
PPF70E7	700 x 700 x 850	4 x 2	4,7	12,7	400-3N 50/60	121

PFX105V7
HORNO VENTILADO GN1/1 CONVECTION OVEN GN1/1
PPF70E7

PP70E7

 SUP. COCCIÓN ELÉCTRICAS PLANCHA+HORNO GN2/1
 GRILL ELECTRIC STOVE SURFACES + OVEN GN2/1

























REF. MOD. P.V.P € / RRP
616013 PPF70E7 4.024

 SUPERFICIES COCCIÓN ELÉCTRICAS DE PLANCHA
 GRILL ELECTRIC STOVE SURFACES

REF. MOD. P.V.P € / RRP
616003 PP70E7 2.554
HORNOS VENTILADOS CONVECTION OVENS
CONSULTAR PRECIOS CHECK PRICE LIST

Línea 700

COCINA ELÉCTRICA + HORNO GN2/1 ELECTRIC STOVE + GN2/1 OVEN

Modelo Model	Dimensiones (L x P x A) Dimensions (W x D x H)	Potencia Quemadores Burners Power	Potencia Horno Oven Power	Potencia Total Total Power	Tensión/Frecuencia Voltage/Frequency	Peso Weight
	mm	kw	kw	kw	V/Hz	kg
PFR70E7 	700 x 700 x 850 	3 x 2,6 + 1 x 1,5	4,7 	14 	400-3N 50/60	74
PFR70V7	HORNO VENTILADO GN1/1 CONVECTION OVEN GN1/1 					
PFR70E71 	700 x 700 x 850 	4 x 2,6	4,7 	15,1 	400-3N 50/60	74
PFR70V71	HORNO VENTILADO GN1/1 CONVECTION OVEN GN1/1 					
PFR105E7 	1050 x 700 x 850 	6 x 2,6	4,7 	20,3 	400-3N 50/60	101
PFR105V7	HORNO VENTILADO GN1/1 CONVECTION OVEN GN1/1 					
PFS70E7 	700 x 700 x 850 	4 x 2,6	4,7 	15,1 	400-3N 50/60	84
PFS70V7	HORNO VENTILADO GN1/1 CONVECTION OVEN GN1/1 					
PFS105E7 	1050 x 700 x 850 	6 x 2,6	4,7 	20,3 	400-3N 50/60	109
PFS105V7	HORNO VENTILADO GN1/1 CONVECTION OVEN GN1/1 					

CARACTERÍSTICAS FEATURES

Quemadores eléctricos redondos o cuadrados. Termostato que reduce automáticamente la potencia erogada al retirar el recipiente. Fijadas herméticamente a la superficie. Ranura antidesbordamiento de líquidos.

Horno eléctrico GN2/1 en acero esmaltado. Rejilla de horno cincada y cromada de serie. Termostato. Conmutador activa la función GRILL, las resistencias inferiores o ambas.

Round or square electric burners. Thermostat which automatically reduces the power delivered when removing the cookware. Hermetically sealed to the surface. Liquid overflow prevention groove.

GN2/1 enamelled steel electric oven. Standard galvanised and chrome oven grille. Thermostat. A switch activates the GRILL function, the lower heating elements or both.

PFR70E7











COCINA ELÉCTRICA+HORNO GN2/1 (+ REJILLA)
ELECTRIC STOVE + OVEN GN2/1 (+ GRILLE)

REF.	MOD.	P.V.P € / RRP
616014	PFR70E7	2.933
616015	PFR70E71	2.933
616016	PFR105E7	3.834
616017	PFS70E7	4.034
616020	PFS105E7	5.667



HORNOS VENTILADOS CONVECTION OVENS 

CONSULTAR PRECIOS CHECK PRICE LIST

COCINA ELÉCTRICA + HORNO FULLSIZE + (REJILLA) ELECTRIC STOVE + FULLSIZE OVEN (+ GRILLE)

Modelo Model	Dimensiones (L x P x A) Dimensions (W x D x H)	Potencia Quemadores Burners Power	Potencia Horno Oven Power	Potencia Total Total Power	Tensión/Frecuencia Voltage/Frequency	Peso Weight
	mm	kW	kW	kW	V/Hz	kg
PFRX105E7 	1050 x 700 x 850 	6 x 2,6	6,3 ⚡	21,9 ⚡	400-3N 50/60	101
PFSX105E7 	1050 x 700 x 850 	6 x 2,6	6,3 ⚡	21,9 ⚡	400-3N 50/60	109
PFRX105VE7 	1050 x 700 x 850 	6 x 2,6	5 ⚡	20,6 ⚡	400-3N 50/60	109
PFSX105VE7 	1050 x 700 x 850 	6 x 2,6	5 ⚡	20,6 ⚡	400-3N 50/60	109

COCINA ELÉCTRICA VITROCERÁMICA + HORNO GN2/1 (+ REJILLA) GLASS CERAMIC-HOB STOVE + OVEN GN2/1 (+ GRILLE)

Modelo Model	Dimensiones (L x P x A) Dimensions (W x D x H)	Potencia Quemadores Burners Power	Potencia Horno Oven Power	Potencia Total Total Power	Tensión/Frecuencia Voltage/Frequency	Peso Weight
	mm	kW	kW	kW	V/Hz	kg
PFC70E7 	700 x 700 x 850 	2 x 2,5 + 2 x 1,8	4,7 ⚡	13,3 ⚡	400-3N 50/60	71

PFC70V7 HORNO VENTILADO GN1/1 CONVECTION OVEN GN1/1 
BASE HORNO OVEN BASE

Modelo Model	Dimensiones (L x P x A) Dimensions (W x D x H)	Potencia Horno Oven Power	Dimensiones Horno Oven Dimensions	Tensión/Frecuencia Voltage/Frequency	Peso Weight
	mm	kW	mm	V/Hz	kg
F70E7 	700 x 700 x 570	4,7 ⚡	GN2/1	400-3N 50/60	68

**COCINA ELÉCTRICA + HORNO FULLSIZE
ELECTRIC STOVE + FULLSIZE OVEN**

REF.	MOD.	P.V.P € / RRP
616022	PFRX105E7	3.972
616021	PFSX105E7	5.871
616024	PFRX105VE7	4.236
616025	PFSX105VE7	6.130

**COCINA VITROCERÁMICA + HORNO GN2/1
GLASS CERAMIC-HOB STOVE + OVEN GN2/1**









REF.	MOD.	P.V.P € / RRP
616023	PFC70E7	4.784

BASE HORNO OVEN BASE









REF.	MOD.	P.V.P € / RRP
616039	F70E7	1.916

Línea 900 Basic









SUPERFICIES DE COCCIÓN A GAS BASIC BASIC GAS STOVE SURFACES

Modelo Model	Dimensiones (L x P x A) Dimensions (W x D x H)	Quemadores Burners	Potencia Quemadores Burners Power	Potencia Total Total Power	Peso Weight
	mm		kW	kW	kg
EC4G9 	400 x 900 x 280		2 x 8	16 	42
EC8G9 	800 x 900 x 280		4 x 8	32 	80
EC12G9 	1200 x 900 x 280		6 x 8	40 	116

SUPERFICIES DE COCCIÓN A GAS BASIC + MÓDULO BAJO BASIC GAS STOVE SURFACES + BELOW UNIT









Modelo Model	Dimensiones (L x P x A) Dimensions (W x D x H)	Quemadores Burners	Potencia Quemadores Burners Power	Potencia Total Total Power	Peso Weight
	mm		kW	kW	kg
EC4FG9 	400 x 900 x 900		2 x 8	16 	64
EC8FG9 	800 x 900 x 900		4 x 8	32 	95
EC12FG9 	1200 x 900 x 900		6 x 8	40 	155

SUPERFICIES DE COCCIÓN A GAS BASIC + HORNO GN2/1 BASIC GAS STOVE SURFACES + OVEN GN2/1

Modelo Model	Dimensiones (L x P x A) Dimensions (W x D x H)	Potencia Quemadores Burners Power	Potencia Horno Oven Power	Potencia Total Total Power	Tensión/Frecuencia Voltage/Frequency	Peso Weight
	mm	kW	kW	kW	V/Hz	kg
EF8GG9 	800 x 900 x 900	 4 x 8	7 	39 	-	134
EF8G9 	800 x 900 x 900	 4 x 8	5,3 	32  5,3 	- 400-3N 50/60	138

EF8V9 HORNO VENTILADO GN1/1 CONVECTION OVEN GN1/1







EF12GG9 	1200 x 900 x 900	 6 x 8	7 	55 	-	192
EF12G9 	1200 x 900 x 900	 6 x 8	5,3 	48  5,3 	- 400-3N 50/60	198

EF12V9 HORNO VENTILADO GN1/1 CONVECTION OVEN GN1/1



COCINAS A GAS BASIC + HORNO FULLSIZE BASIC GAS STOVES + FULLSIZE OVEN

Modelo Model	Dimensiones (L x P x A) Dimensions (W x D x H)	Quemadores Burners	Potencia Quemadores Burners Power	Potencia Horno Oven Power	Potencia Total Total Power	Peso Weight
	mm		kW	kW	kW	kg
EFXG12GG9 	1200 x 900 x 900		6 x 8	9 	57 	205

ACCESORIOS LÍNEA 900 BASIC 900 BASIC LINE ACCESSORIES

REF.	DENOMINACIÓN NAME		P.V.P € / RRP
319012	PUERTA IZQUIERDA / DERECHA LEFT / RIGHT DOOR		182,00
220590	REJILLA HORNO GN2/1. Dimensiones: 530 x 650 mm GN2/1 OVEN GRILLE. Dimensions: 530 x 650 mm		39,00
619004	REJILLA HORNO GN1/1. Dimensiones: 530 x 470 mm GN1/1 OVEN GRILLE. Dimensions: 530 x 470 mm		39,00
220595	REJILLA HORNO FULLSIZE. Dimensiones: 880 x 620 mm FULLSIZE OVEN GRILLE. Dimensions: 880 x 620 mm		76,00

**SUP. COCCIÓN A GAS BASIC
BASIC GAS STOVE SURFACES**

REF.	MOD.	P.V.P € / RRP
313096	EC4G9	1.454
313097	EC8G9	2.230
313098	EC12G9	3.245

**SUP. COCCIÓN A GAS BASIC + MOD.BAJO
BASIC GAS STOVE + BELOW UNIT**

REF.	MOD.	P.V.P € / RRP
313099	EC4FG9	1.767
313100	EC8FG9	3.116
313101	EC12FG9	3.786

**SUP. COCCIÓN A GAS BASIC+HORNO GN2/1
BASIC GAS STOVE SURFACES + OVEN GN2/1**

























REF.	MOD.	P.V.P € / RRP
313102	EF8GG9	3.913
313103	EF8G9	4.371
313104	EF12GG9	5.518
313105	EF12G9	5.697

**SUP. COCCIÓN A GAS BASIC+HORNO FULLSIZE
BASIC GAS STOVE + FULLSIZE OVEN**

REF.	MOD.	P.V.P € / RRP
313106	EFX12GG9	5.576

Línea 900

SUPERFICIES DE COCCIÓN A GAS GAS STOVE SURFACES

Modelo Model	Dimensiones (L x P x A) Dimensions (W x D x H)	Quemadores Burners	Potencia Quemadores Burners Power	Potencia Total Total Power	Peso Weight
	mm		kW	kW	kg
PCG4G9 	400 x 900 x 280		1 x 5,5 + 1 x 9	14,5 	42
PCG4SG9 	400 x 900 x 280		2 x 9	18 	42
PCG8G9 	800 x 900 x 280		2 x 5,5 + 2 x 9	29 	80
PCG8SG9 	800 x 900 x 280		4 x 9	36 	80
PCG12G9 	1200 x 900 x 280		4 x 5,5 + 2 x 9	40 	116
PCG12SG9 	1200 x 900 x 280		6 x 9	54 	118
PP8G9 	800 x 900 x 280		1 x 11	11 	90
PCPG12G9 	1200 x 900 x 280		1 x 5,5 + 1 x 9 + 1 x 11	25,5 	125

PLACA FRANCESA FRENCH PLATE

Placa de hierro colado pulido de 10 mm de espesor indeformable.

Zonas térmicas diferenciadas con temperatura máxima en el quemador central y en disminución hacia el exterior.

Smooth cast-iron plate with 10 mm torsion-resistant thickness

Different heat zones with maximum temperature on the central burner decreasing outwards





















PCP12G9



SUP. COCCIÓN A GAS GAS STOVE SURFACES

REF.	MOD.	P.V.P € / RRP
313001	PCG4G9	1.652
313002	PCG4SG9	1.811
313003	PCG8G9	2.540
313004	PCG8SG9	2.910
313005	PCG12G9	3.687
313113	PCG12SG9	3.940
313006	PP8G9	2.588
313007	PCP12G9	3.461

SUPERFICIES DE COCCIÓN A GAS + MÓDULO BAJO GAS STOVE SURFACES + BELOW UNIT

Modelo Model	Dimensiones (L x P x A) Dimensions (W x D x H) mm	Quemadores Burners	Potencia Quemadores Burners Power kW	Potencia Total Total Power kW	Peso Weight kg
PCG4FG9 	400 x 900 x 900		1 x 5,5 + 1 x 9	14,5 	64
PCG4FSG9	400 x 900 x 900		2 x 9	18 	64
PCG8FG9 	800 x 900 x 900		2 x 5,5 + 2 x 9	29 	95
PCG8FSG9	800 x 900 x 900		4 x 9	36 	95
PCG12FG9 	1200 x 900 x 900		4 x 5,5 + 2 x 9	40 	155
PCG12FSG9	1200 x 900 x 900		6 x 9	54 	155
PP8FG9 	800 x 900 x 900		1 x 1	11 	125
PCPG12FG9 	1200 x 900 x 900		1 x 5,5 + 1 x 9 + 1 x 11	25,5 	165











PP8FG9

SUP. COCCIÓN A GAS + MÓDULO BAJO
GAS STOVE SURFACES + BELOW UNIT

REF.	MOD.	P.V.P € / RRP
313014	PCG4FG9	2.022
313015	PCG4FSG9	2.159
313016	PCG8FG9	3.121
313017	PCG8FSG9	3.461
313018	PCG12FG9	4.304
313115	PCG12FSG9	4.535
313019	PP8FG9	3.198
313020	PCPG12FG9	4.242

Línea 900

COCINAS A GAS + HORNO GN2/1 GAS STOVES + OVEN GN2/1

Modelo Model	Dimensiones (L x P x A) Dimensions (W x D x H)	Potencia Quemadores Burners Power	Potencia Horno Oven Power	Potencia Total Total Power	Tensión/Frecuencia Voltage/Frequency	Peso Weight
	mm	kW	kW	kW	V/Hz	kg
PFG8GG9 	800 x 900 x 900 	2 x 5,5 + 2 x 9	7 	36 	-	134
PFG8SGG9	800 x 900 x 900 	4 x 9	7 	43 	-	160
PFG8G9	800 x 900 x 900 	2 x 5,5 + 2 x 9	5,3 	29  5,3 	- 400-3N 50/60	138

PFG8V9

HORNO VENTILADO GN1/1 CONVECTION OVEN GN1/1







PPF8GG9 	800 x 900 x 900 	1 x 11	7 	18 	-	154
PFPG12GG9 	1200 x 900 x 900 	1 x 5,5 + 1 x 9 + 1 x 11	7 	32,5 	-	192
PFG12GG9 	1200 x 900 x 900 	4 x 5,5 + 2 x 9	7 	47 	-	192
PFG12SGG9	1200 x 900 x 900 	6 x 9	7 	61 	-	192
PFG12G9	1200 x 900 x 900 	4 x 5,5 + 2 x 9	5,3 	40  5,3 	- 400-3N 50/60	198
PFG12SG9	1200 x 900 x 900 	6 x 9	5,3 	54  5,3 	- 400-3N 50/60	198

PFG12V9

HORNO VENTILADO GN1/1 CONVECTION OVEN GN1/1



P2FG16GG9 	1600 x 900 x 900 	4 x 5,5 + 4 x 9	7 + 7 	72 	-	300
--	--	-----------------	---	--	---	-----

COCINAS A GAS + HORNO FULLSIZE GAS STOVES + FULLSIZE OVEN

Modelo Model	Dimensiones (L x P x A) Dimensions (W x D x H)	Potencia Quemadores Burners Power	Potencia Hornos Oven Power	Potencia Total Total Power	Tensión/Frecuencia Voltage/Frequency	Peso Weight
	mm	kW	kW	kW	V/Hz	kg
PFXG12GG9	1200 x 900 x 900	4 x 5,5 + 2 x 9	9	49	-	205
PFXG12SGG9	1200 x 900 x 900	6 x 9	9	63	-	205
PFXG12GGE9	1200 x 900 x 900	4 x 5,5 + 2 x 9	7 3	40 3 7	230-1 50/60	210
PFXG12SGGE9	1200 x 900 x 900	6 x 9	7 3	54 3 7	230-1 50/60	210

PFG12GG9

**COCINAS A GAS + HORNO GN2/1
GAS STOVE + OVEN GN2/1**

REF.	MOD.	P.V.P € / RRP
313027	PFG8GG9	4.288
313028	PFG8SGG9	4.504
313029	PFG8G9	4.748
313031	PPF8GG9	4.748
313032	PFPG12GG9	5.865
313033	PFG12GG9	6.034
313117	PFG12SGG9	6.090
313034	PFG12G9	6.218
313118	PFG12SG9	6.390
313037	P2FG16GG9	8.237











**COCINAS A GAS + HORNO FULLSIZE
GAS STOVE + FULLSIZE OVEN**

REF.	MOD.	P.V.P € / RRP
313036	PFXG12GG9	6.095
313119	PFXG12SGG9	6.275
313109	PFXG12GGE9	6.355
313120	PFXG12SGGE9	6.530



Línea 900

SUPERFICIES DE COCCIÓN ELÉCTRICAS ELECTRIC STOVE SURFACES

Modelo Model	Dimensiones (L x P x A) Dimensions (W x D x H)	Dimensiones Placas Plate Dimensions	Potencia Quemadores Burners Power	Potencia Total Total Power	Tensión/Frecuencia Voltage/Frequency	Peso Weight
	mm	mm	kW	kW	V/Hz	kg
PC4E9 	400 x 900 x 280	300 x 300 	2 x 4	8	400-3N 50/60	38
PC8E9 	800 x 900 x 280	300 x 300 	4 x 4	16	400-3N 50/60	75
PC12E9 	1200 x 900 x 280	300 x 300 	6 x 4	24	400-3N 50/60	100
PP4E9 	400 x 900 x 280	- 	2 x 3,5	7	400-3N 50/60	70
PP8E9 	800 x 900 x 280	- 	4 x 3,5	14	400-3N 50/60	110

PC12E9













PP8E9





SUPERFICIES COCCIÓN ELÉCTRICAS ELECTRIC STOVE SURFACES

REF.	MOD.	P.V.P € / RRP
316001	PC4E9	2.289
316003	PC8E9	3.732
316005	PC12E9	4.977
316122	PP4E9	3.256
316007	PP8E9	3.670

**SUPERFICIES DE COCCIÓN ELÉCTRICAS + MÓDULO BAJO ELECTRIC STOVE SURFACES + BELOW UNIT**

Modelo Model	Dimensiones (L x P x A) Dimensions (W x D x H)	Dimensiones Placas Plate Dimensions	Potencia Quemadores Burners Power	Potencia Total Total Power	Tensión/Frecuencia Voltage/Frequency	Peso Weight
	mm	mm	kW	kW	V/Hz	kg
PC4FE9 	400 x 900 x 900	300 x 300 	2 x 4	8	400-3N 50/60	54
PC8FE9 	800 x 900 x 900	300 x 300 	4 x 4	16	400-3N 50/60	89
PC12FE9 	1200 x 900 x 900	300 x 300 	6 x 4	24	400-3N 50/60	128
PP4FE9 	400 x 900 x 900	- 	2 x 3,5	7	400-3N 50/60	75
PP8FE9 	800 x 900 x 900	- 	4 x 3,5	14	400-3N 50/60	125

SUPERFICIES DE COCCIÓN ELÉCTRICAS DE PLANCHA + HORNO GN2/1 ELECTRIC GRILL STOVE SURFACES + OVEN GN2/1

Modelo Model	Dimensiones (L x P x A) Dimensions (W x D x H)	Potencia Quemadores Burners Power	Potencia Horno Oven Power	Potencia Total Total Power	Tensión/Frecuencia Voltage/Frequency	Peso Weight
	mm	kW	kW	kW	V/Hz	kg
PPF8E9 	800 x 900 x 900	4 x 3,5 	5,3	19,3	400-3N 50/60	180

PPF8VE9 HORNO VENTILADO GN1/1 CONVECTION OVEN GN1/1**CARACTERÍSTICAS FEATURES**

4 zonas de calentamiento gestionadas de manera autónoma con temperaturas distintas. Acero indeformable de 15 mm de espesor. Soporta temperaturas de hasta 450°C. Sobre encimera, monoblock y sobre horno GN2/1.

4 heating zones controlled independently with different temperatures. 15 mm thick torsion-resistant steel. Supports temperatures of up to 450°C. On countertop, monoblock and on oven GN2/1

**SUP. COCCIÓN ELÉCTRICAS + MÓDULO BAJO
ELECTRIC STOVE SURFACES + BELOW UNIT**

REF.	MOD.	P.V.P € / RRP
316009	PC4FE9	2.649
316011	PC8FE9	4.253
316013	PC12FE9	5.973
316123	PP4FE9	3.434
316015	PP8FE9	4.213









**SUP. COCCIÓN ELÉCTRICAS + HORNO GN2/1
ELECTRIC STOVE SURFACES + OVEN GN2/1**

REF.	MOD.	P.V.P € / RRP
313043	PPF8E9	5.462

HORNOS VENTILADOS CONVECTION OVENS**CONSULTAR PRECIOS CHECK PRICE LIST**

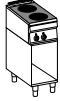
Línea 900

SUPERFICIES DE COCCIÓN VITROCERÁMICAS GLASS CERAMIC-HOB STOVE SURFACES

Modelo Model	Dimensiones (L x P x A) Dimensions (W x D x H)	Zona Calentamiento Heating Zone	Potencia Zona Zone Power	Potencia Total Total Power	Tensión/Frecuencia Voltage/Frequency	Peso Weight
	mm		kW	kW	V/Hz	kg
PCC4E9 	400 x 900 x 280		2 x 3,4	6,8	400-3N 50/60	24
PCC8E9 	800 x 900 x 280		4 x 3,4	13,6	400-3N 50/60	69
PCC4FE9 	400 x 900 x 900		2 x 3,4	6,8	400-3N 50/60	60
PCC8FE9 	800 x 900 x 900		4 x 3,4	13,6	400-3N 50/60	99













Composición formada por módulos de la línea 900 con vitrocerámica modelo PCC8E9
Made up of modules from the 900 line with PCC8E9 model glass ceramic hob

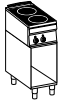

SUPERFICIES COCCIÓN VITROCERÁMICAS GLASS CERAMIC-HOB STOVE SURFACES

REF.	MOD.	P.V.P € / RRP
316017	PCC4E9	2.871
316019	PCC8E9	4.656
316021	PCC4FE9	3.374
316023	PCC8FE9	5.335

SUPERFICIES DE COCCIÓN POR INDUCCIÓN INDUCTION STOVE SURFACES

Modelo Model	Dimensiones (L x P x A) Dimensions (W x D x H)	Zona Calentamiento Heating Zone	Potencia Zona Zone Power	Potencia Total Total Power	Tensión/Frecuencia Voltage/Frequency	Peso Weight
	mm		kW	kW	V/Hz	kg
PIN4E9 	400 x 900 x 280		2 x 5	10 	400-3N 50/60	35
PIN8E9 	800 x 900 x 280		4 x 5	20 	400-3N 50/60	69
PIN4FE9 	400 x 900 x 900		2 x 5	10 	400-3N 50/60	60
PIN8FE9 	800 x 900 x 900		4 x 5	20 	400-3N 50/60	99

CARACTERÍSTICAS FEATURES

Máxima operatividad en la cocina.

Velocidad: Calentamiento y regulación de la temperatura inmediatos.

Ahorro energético: Rendimiento energético del 85% de la energía total suministrada.

Trabajo cómodo y seguro: La superficie está siempre fría.

Facilidad de limpieza.

Maximum operability in the kitchen

Speed: Immediate heating and temperature regulation

Energy saving: Energy saving of 85% of total energy supplied

Comfortable and safe work: The surface is always cold

Easy to clean

PCC4E9

**SUPERFICIES COCCIÓN POR INDUCCIÓN
INDUCTION STOVE SURFACES**

REF.	MOD.	P.V.P € / RRP
316025	PIN4E9	8.986
316026	PIN8E9	17.082
316027	PIN4FE9	9.373
316028	PIN8FE9	17.563

Línea 900

COCINAS ELÉCTRICAS + HORNO GN2/1 ELECTRIC STOVES + OVEN GN2/1

Modelo Model	Dimensiones (L x P x A) Dimensions (W x D x H)	Potencia Quemadores Burners Power	Potencia Horno Oven Power	Potencia Total Total Power	Tensión/Frecuencia Voltage/Frequency	Peso Weight
PF8E9	800 x 900 x 900 	4 x 4	5,3	21,3	400-3N 50/60	128



PF8VE9

HORNO VENTILADO GN1/1 CONVECTION OVEN GN1/1



PF12E9

1200 x 900 x 900 

6 x 4

5,3

29,3

400-3N 50/60

190



PF12VE9

HORNO VENTILADO GN1/1 CONVECTION OVEN GN1/1



COCINA ELÉCTRICA VITROCERÁMICA + HORNO GN2/1 GLASS CERAMIC-HOB ELECTRIC STOVE + OVEN GN2/1

Modelo Model	Dimensiones (L x P x A) Dimensions (W x D x H)	Potencia Quemadores Burners Power	Potencia Horno Oven Power	Potencia Total Total Power	Tensión/Frecuencia Voltage/Frequency	Peso Weight
PFC8E9	800 x 900 x 900 	4 x 3,4	5,3	18,9	400-3N 50/60	150



PF12VE9

HORNO VENTILADO GN1/1 CONVECTION OVEN GN1/1



PFC8E9



COCINAS ELÉCTRICAS + HORNO GN2/1 ELECTRIC STOVE + OVEN GN2/1

REF.	MOD.	P.V.P € / RRP
316037	PF8E9	5.973
316039	PF12E9	8.313

COCINA VITROCERÁMICA + HORNO GN2/1 GLASS CERAMIC-HOB STOVE + OVEN GN2/1

REF.	MOD.	P.V.P € / RRP
316041	PFC8E9	6.992

HORNOS VENTILADOS CONVECTION OVENS



CONSULTAR PRECIOS CHECK PRICE LIST



Si este documento no incluye las marcas o productos que fabrica o distribuye su empresa, notifíquenoslo en contacto@hosteleria10.com.

Estaremos encantados de incorporarlas.