



Catálogo de las
MESAS
DE
CONGELACIÓN
distribuidas en España

Este catálogo agrupa toda la información disponible sobre los [Mesas de Congelación](#) que se distribuyen en España, según la facilitan sus respectivos fabricantes. Esta información incluye productos, modelos, características técnicas y precios.

Los precios indicados en este catálogo son los Precios de Venta Recomendados por cada fabricante, que puede haberlos actualizado, dejándolos obsoletos. Consúltanos el precio actual.

En todo caso, en la tienda online Hostelería10.com mejoramos con grandes descuentos los precios de todos los productos incluidos en este catálogo.

Las marcas de la sección [Mesas de Congelación](#) que forman parte de este catálogo son:

Casfri	Fagor
Clima Hostelería	granita
Coreco	Fimar
Corequip	Infrico
Docriluc	Masquefrio
Edenox	Mes Fred
Eurofred	Sayl
Eutron	

Sólo una cuidada selección de los mejores productos de este catálogo están incluidos en Hostelería10.com.

Si tienes alguna duda respecto a alguno de estos productos o no encuentras el que buscas, escríbenos a contacto@hosteleria10.com o llámanos al 91 161 03 04.

Estaremos encantados de atenderle.

MESAS FRÍAS CONGELADOS - FONDO 700 - GN-1/1

SERIE INTER



Modelo	EUROS
MC-1360-BT	1.795
MC-1800-BT	1.998
PARRILLA-GN-1/1	28



MC-1360-BT



MC-1800-BT

CARACTERÍSTICAS TÉCNICAS

- Exterior en acero inoxidable excepto el panel trasero.
- Interior en acero inoxidable con esquinas de la base redondeadas.
- Puerta de acero inoxidable.
- Encimera con peto trasero sanitario de 100mm.
- Estantes inferiores de alambre de acero plastificado, regulables en altura.
- Patas ajustables en acero inoxidable.
- Puertas con cierre automático.
- Temperatura de trabajo de -18 / -22°C a una temperatura ambiente de 35°C.
- Refrigerante R-290.
- Aislamiento inyectado de poliuretano 40 Kg. CFC.
- Evaporación automática de agua durante el desescarche.
- Temperatura electrónica.
- Control de desescarche y display.
- Sistema de tiro forzado.

DOTACIÓN:

- MC-130: 2 parrillas / MC-1800: 3 parrillas
- Iluminación interna



Modelo	Largo	Fondo	Altura	Volumen	Rango Temp.	Consumo	Potencia	Tensión Freq.	Gas
MC-1360-BT	1360 mm	700 mm	850 mm	282	-18°C / 22°C	625	550 W	230 V - 50 Hz	R-290
MC-1800-BT	1800 mm	700 mm	850 mm	417	-18°C / 22°C	690	580 W	230 V - 50 Hz	R-290



Línea CÓRDOBA

Si estás bajo la impresión de que has alcanzado la perfección, nunca alcanzarás las alturas de las que eres capaz.
Kazuo Ishiguro

Mesas Refrigeradas



Puerta con Tirador Integrado



Puerta de cristal



MCCH-200
MRCH-200



PRODUCTO SIMILAR
Consulte Página

43

44

45

Mesa Snack Refrigerada Fondo 600

MODELO	PUERTAS	TEMPERATURA (°C)	CAPACIDAD (L)	CLASE ENERGÉTICA	CONSUMO (kWh/Año)	POTENCIA (W)	DIMENSIONES (AxFxH) mm	PRECIO (EUR)
MRCH-150	2	-2 / +8	250	C	1019	220	1492x600x850	1.664
MRCH-200	3	-2 / +8	390	C	1118	220	2017x600x850	1.926
MRCH-250	4	-2 / +8	530	D	1920	350	2542x600x850	2.302

Mesa Snack Refrigerada Fondo 600

MODELO	PUERTAS	TEMPERATURA (°C)	CAPACIDAD (L)	CLASE ENERGÉTICA	CONSUMO (kWh/Año)	POTENCIA (W)	DIMENSIONES (AxFxH) mm	PRECIO (EUR)
MRCH-150V	2	-2 / +8	250	C	1019	220	1492x600x850	1.926
MRCH-200V	3	-2 / +8	390	C	1118	220	2017x600x850	2.218
MRCH-250V	4	-2 / +8	530	D	1920	350	2542x600x850	2.623

Mesa Snack Mantenimiento Congelados Fondo 600

MODELO	PUERTAS	TEMPERATURA (°C)	CAPACIDAD (L)	CLASE ENERGÉTICA	CONSUMO (kWh/Año)	POTENCIA (W)	DIMENSIONES (AxFxH) mm	PRECIO (EUR)
MCCH-150	2	-18 / -20	250	D	2212	670	1492x600x850	2.150
MCCH-200	3	-18 / -20	390	D	2467	680	2017x600x850	2.253

Características Técnicas

- Fabricante nacional con más de 30 años de experiencia y referente en el mercado internacional.
- Fabricado en Acero inoxidable AISI-304 en interior y exterior del mueble.
- Compresores DANFOSS SECOP.
- Aislamiento de poliuretano inyectado de 40 Kg/m³ de densidad.
- Ángulos redondeados en interior y encimera con peto sanitario de 100 mm.
- Evaporador tiro forzado con recubrimiento anticorrosión.
- Control electrónico y digital de la temperatura y del desescarche.
- Evaporación automática del agua del desescarche.
- Patas de acero inoxidable regulables en altura.
- Estantes de acero plastificado con soportes de sujeción regulable en altura.
- Excelente relación calidad precio.
- Las mesas con puertas de cristal están equipadas con cerradura e iluminación LED.
- Fiabilidad garantizada por el uso de componentes de alta calidad, compresores de bajo consumo y la optimización de los parámetros de los controles electrónicos testados en nuestros laboratorios.
- La unidad de refrigeración está protegida por una rejilla pivotante facilitando su acceso y mantenimiento. Su diseño cuenta con un amplio sistema de aireación frontal y una toma de aire adicional encima de la rejilla para facilitar la circulación del aire. En caso de espacios reducidos este sistema mejora el funcionamiento del grupo de manera significativa.
- Puertas con dispositivo automático de cierre y fijación de apertura que nos aporta ahorro de energía y comodidad en el trabajo cotidiano. Las puertas disponen de tirador integrado fácil de limpiar.
- Cuentan de serie con todos los elementos para facilitar la limpieza: burlete sustituable, guías desmontables, fondo embutido sanitario, uniones curvas, desagüe que permite la evacuación de líquidos residuales.
- Gas refrigerante ecológico R-290.



MESAS REFRIGERADAS REFRIGERATED COUNTERS

600 (snack)



Pag. 24-29

Mesa fría SNACK
SNACK refrigerated counter



Pag. 30-35

Mesa fría SNACK frente mostrador
Back bar SNACK counter



Pag. 35-41

Muebles neutros
Neutral complements

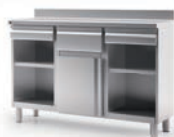

700 (GN 1/1)



Pag. 42-43

Mesa fría GN1/1 bajo-mostrador ALTA EFICIENCIA
HIGH EFFICIENCY GN 1/1 counter



Pag. 44-49

Mesa fría GN1/1 bajo-mostrador
GN 1/1 counter

Pag. 50-51

Mesa fría GN1/1 central
pass through GN 1/1 counter

Pag. 52-53

Mesa fría GN1/1 compacta
Compact GN 1/1 counter



Pag. 54-57

Mesa fría GN bajo-cocina
Under broiler GN counter

800 (60x40)



Pag. 58-61

Mesa fría 60x40 bajo-mostrador
60x40 counter



CARACTERISTICAS GENERALES GENERAL FEATURES

600 (snack)



700 (GN 1/1)



800 (60x40)



- Exterior en acero inox AISI-304, excepto el respaldo
- Interior en acero inox AISI-304
- Puertas de apertura reversible, con sistema de cierre automático y burlete magnético (permanece abierta al superar los 90° de apertura)
- Contrapuerta inox embutida
- Encimera con frente curvo y peto trasero sanitario de 100 mm (según modelo puede variar)
- Estantes interiores de alambre en acero plastificado, regulables en altura (según modelo puede variar)
- Pies en acero inox (160 mm) ajustables en altura
- Unidad condensadora ventilada y extraíble en el lado derecho
- Evaporador en la parte superior, con tratamiento anticorrosión
- Evaporación automática del agua de descarche

- AISI-304 stainless steel exterior, rear side galvanized panel
- AISI-304 stainless steel interior
- Doors with self closing system, blocked opening, magnetic gasket and possibility of changing the opening sense
- Worktop with rounded front and 100 mm sanitary upstand (depending on model, can change)
- Plasticized steel wire shelves, height adjustable (depending on model, can change)
- Stainless steel adjustable legs
- Right side removable and fan assisted condenser unit
- Evaporator on the upper internal side, coated with anti-corrosion material
- Automatic evaporation of defrost water

AISI-304

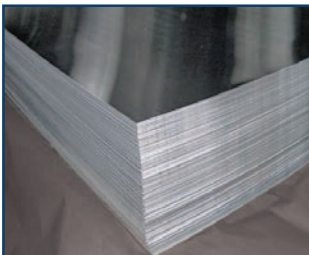

hidrocarburo de serie
standard hydrocarbon



patas de 160 mm
160 mm leg



bisagras cierre automático
self closing hinges



interior esquinas redondeadas
rounded corner edges



contrapuerta embutida
pressformed rear door



evaporador en el techo
top mounted evaporator



unidad cond. extraíble
removable cond. unit

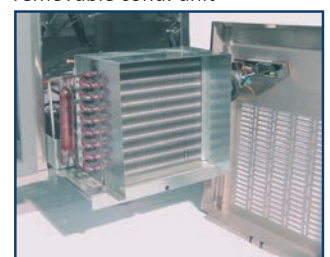

desagüe limpieza
cleaning drainage

burlete desmontable
gasket detachable



OPCIONES BAJO PEDIDO OPTIONS ON DEMAND

sin peto
no splash-back



exterior blanco o negro
black or white exterior



motor lado izquierdo
left side condenser unit



fregadero
sink



puerta con cerradura
lock for door



respaldo inox
SS rear side



encimera de granito
granite worktop



cajones (autocierre)
drawers (selfclosing)



estantes chapa perforada
perforated shelves

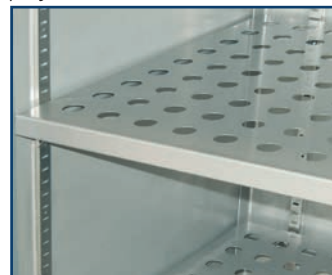

patas de 90 mm
90 mm legs



puertas de cristal
glass doors



gases alternativos a hidrocarburos
hydrocarbon alternative gases



ruedas
castors



cajones frente de cristal
drawers with front glass



voltaje y frecuencia
voltage and frequency

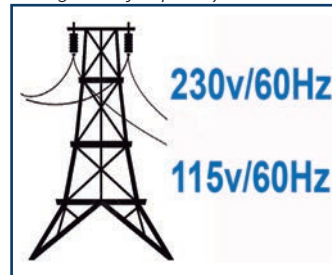



MRS-150	2.174 €
MRSF-150	2.458 €
MCS-150	2.758 €



MRS-200	2.579 €
MRSF-200	2.847 €
MCS-200	3.186 €



MRS-250	3.051 €
MRSF-250	3.345 €



MRS-300	3.652 €
MRSF-300	4.034 €

mod.	rango range °C	largo length (mm)	alto height (mm)	fondo depth (mm)	estantes shelves	volumen capacity (L)	voltaje voltage	refrigerante refrigerant	potencia frig. frig. power W	potencia power W	CCE EEC 2015/1094 EN16825	clase climate 2015/1094 EN16825
MRS-150	-2°C +8°C	1495	850	600	2	245	230V-50Hz	R134a*	178	211	-	5 40°C 40%
								R290	502	235	B	5 40°C 40%
MRS-200	-2°C +8°C	2020	850	600	3	380	230V-50Hz	R134a*	245	249	-	5 40°C 40%
								R290	502	238	B	5 40°C 40%
MRS-250	-2°C +8°C	2545	850	600	4	516	230V-50Hz	R134a*	304	289	-	5 40°C 40%
								R290	845	340	C	5 40°C 40%
MRS-300	-2°C +8°C	3070	850	600	5	651	230V-50Hz	R134a*	356	304	-	5 40°C 40%
								R290	845	355	C	5 40°C 40%
MCS-150	-20°C -15°C	1495	850	600	2	245	230V-50Hz	R290	606	535	-	5 40°C 40%
								R449A*	353	556	E	4 30°C 55%
MCS-200	-20°C -15°C	2020	850	600	3	380	230V-50Hz	R290	606	556	-	4 30°C 55%
								R449A*	452	610	E	4 30°C 55%

* no disponible mercado UE - not for EU market

Características técnicas y constructivas sujetas a variación sin previo aviso.

- Exterior en acero inox AISI-304, excepto el respaldo
- Interior en acero inox AISI-304, con aristas curvas y fondo embutido
- Puertas de apertura reversible, con sistema de cierre automático y burlete magnético (permanece abierta al superar los 90° de apertura)
- Contrapuerta inox embutida
- Encimera de acero inox AISI-304 con frente curvo y peto trasero sanitario de 100 mm (opcional sin peto)
- Estantes interiores de alambre en acero plastificado, regulables en altura, sobre apoyos inox
- Pies en tubo de acero inox ajustables en altura 135 - 210 mm
- Unidad condensadora ventilada y extraíble
- Evaporador sistema tiro forzado, con recubrimiento epoxi anticorrosión
- Evaporación automática del agua de descarche
- Aislamiento de poliuretano inyectado, densidad 40 Kg/m³, cero efectos ODP y GWP
- Control digital de temperatura, descarches optimizados, alarma por alta temperatura de condensación. Eficiente gestión del consumo de energía
- Condiciones de trabajo: MRS 40°C MCS 32° ambiente

We reserve the right to change specifications without prior notice.

- AISI-304 stainless steel exterior, rear side galvanized panel
- AISI-304 stainless steel interior, stamped bottom and rounded corners
- Doors with self closing system, blocked opening, magnetic gasket and possibility of changing the opening sense
- Inner side of doors by stamped steel
- AISI-304 stainless steel worktop, with rounded front and 100 mm sanitary upstand (optional without upstand)
- Shelves made of plasticized steel wire, height adjustable by stainless steel supports
- AISI-304 adjustable legs, 135 to 210 mm
- Removable and fan assisted condenser unit
- Fan assisted evaporator, with epoxi anticorrosion coating.
- Automatic evaporation of defrost water
- 40 Kg/m³ density polyurethane insulation, zero ODP and GWP
- Digital temperature control, optimized defrost, high-temperature condensation alarm. Efficient management of energy consumption
- Operating: MRS 40°C MCS 32° ambient

OPCIONES	OPTIONS	€
parilla adicional	additional grill	23 €
cambio R290 por R134a	change R290 for R134a	0 €
cambio R290 por R449A	change R290 for R449A	0 €
cajonera doble inox, auto-cierre	double SS drawer, self-closing	453 €
cajonera triple inox, auto-cierre	triple SS drawer, self-closing	676 €
cerradura puerta inox	SS door lock	23 €
cerradura puerta cristal	glass door lock	58 €
motor lado izquierdo	left side motor	69 €
encimera sin peto	worktop without splash-back	0 €
set 4 ruedas	set 4 wheels	93 €
set 6 ruedas	set 6 wheels	139 €
registrador de alarmas HACCP	HACCP alarm recorder	consultar
tropicalizado 43°C	tropicalized 43 °C	consultar
230V 60Hz / 115V 60Hz	230V 60Hz / 115V 60Hz	consultar
respaldo inox	SS rear side	consultar

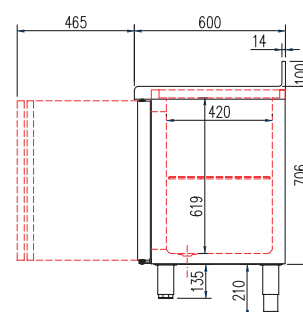

MRSF
Toma desagüe fregadero
Sink drain outlet

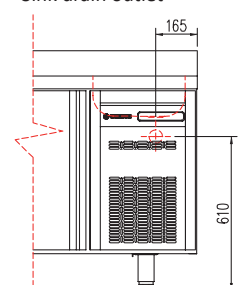



MRS-200



MRS-200
con cajones auto-cierre
with soft-closing drawers

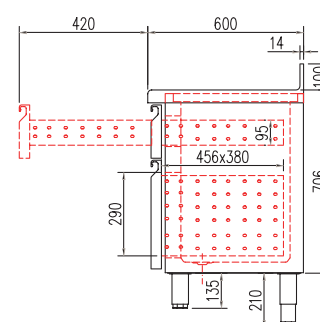
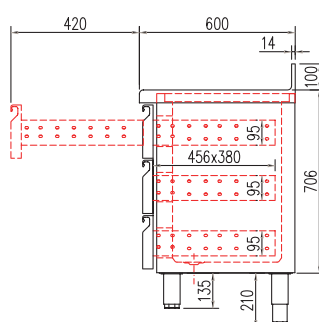
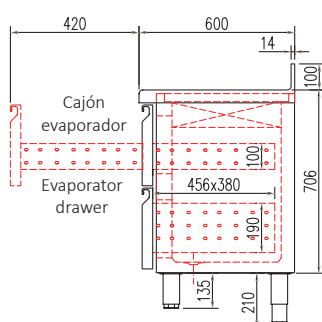
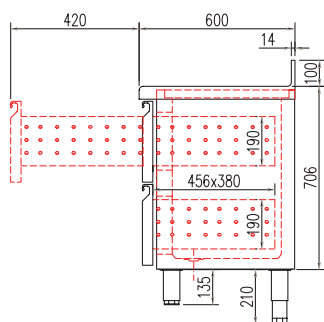
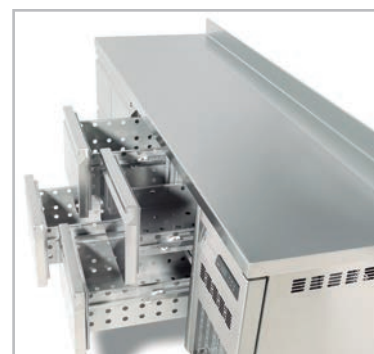

sin peto opcional
optinal, no splash-back

Fregadero 340 x 360 x 160
340 x 360 x 160 Sink





MRSV-150	2.550 €
MCSV-150	3.116 €



MRSV-200	3.083 €
MCSV-200	3.733 €



MRSV-250	3.701 €
MCSV-250	4.497 €



MRSV-300	4.411 €
----------	---------

mod.	rango range °C	largo length (mm)	alto height (mm)	fondo depth (mm)	estantes shelves	volumen capacity (L)	volumen capacity (L)	voltaje voltage	refrigerante refrigerant	potencia frig. frig. power	potencia power W	CCE EEC 2015/1094 EN16825	clase climate 2015/1094 EN16825
MRSV-150	-2°C +8°C	1495	850	600	2	245	245	230V-50Hz	R134a*	304	353	-	4 30°C 55%
									R290	502	243	C	5 40°C 40%
MRSV-200	-2°C +8°C	2020	850	600	3	380	380	230V-50Hz	R134a*	304	306	-	4 30°C 55%
									R290	502	251	C	5 40°C 40%
MRSV-250	-2°C +8°C	2545	850	600	4	516	516	230V-50Hz	R134a*	485	447	-	4 30°C 55%
									R290	845	357	D	5 40°C 40%
MRSV-300	-2°C +8°C	3070	850	600	5	651	651	230V-50Hz	R134a*	485	451	-	4 30°C 55%
									R290	845	380	D	5 40°C 40%
MCSV-150	-20°C -15°C	1495	850	600	2	245	245	230V-50Hz	R290	606	544	E	4 30°C 55%
									R449A*	353	565	-	4 30°C 55%
MCSV-200	-20°C -15°C	2020	850	600	3	380	380	230V-50Hz	R290	606	548	E	4 30°C 55%
									R449A*	452	623	-	4 30°C 55%

* no disponible mercado UE - not for EU market

Características técnicas y constructivas sujetas a variación sin previo aviso.

- Exterior en acero inox AISI-304, excepto el respaldo
- Interior en acero inox AISI-304, con aristas curvas y fondo embutido
- Puertas de apertura reversible, con sistema de cierre automático y burlete magnético (permanece abierta al superar los 90° de apertura)
- Doble cristal + LEDs
- Encimera de acero inox AISI-304 con frente curvo y peto trasero sanitario de 100 mm (opcional sin peto)
- Estantes interiores de alambre en acero plastificado, regulables en altura, sobre apoyos inox
- Pies en tubo de acero inox ajustables en altura 135 - 210 mm
- Unidad condensadora ventilada y extraíble
- Evaporador sistema tiro forzado, con recubrimiento epoxi anticorrosión
- Evaporación automática del agua de descarche
- Aislamiento de poliuretano inyectado, densidad 40 Kg/m³, cero efectos ODP y GWP
- Control digital de temperatura, descarches optimizados, alarma por alta temperatura de condensación. Eficiente gestión del consumo de energía
- Condiciones de trabajo: 32°C ambiente

We reserve the right to change specifications without prior notice.

- AISI-304 stainless steel exterior, rear side galvanized panel
- AISI-304 stainless steel interior, stamped bottom and rounded corners
- Doors with self closing system, blocked opening, magnetic gasket and possibility of changing the opening sense
- Double glazed doors + LEDs
- AISI-304 stainless steel worktop, with rounded front and 100 mm sanitary upstand (optional without upstand)
- Shelves made of plasticized steel wire, height adjustable by stainless steel supports
- AISI-304 adjustable legs, 135 to 210 mm
- Removable and fan assisted condenser unit
- Fan assisted evaporator, with epoxi anticorrosion coating.
- Automatic evaporation of defrost water
- 40 Kg/m³ density polyurethane insulation, zero ODP and GWP
- Digital temperature control, optimized defrost, high-temperature condensation alarm. Efficient management of energy consumption
- Operating: 32°C ambient

OPCIONES	OPTIONS	€
parilla adicional	additional grill	23 €
cambio R290 por R134a	change R290 for R134a	0 €
cambio R290 por R449A	change R290 for R449A	0 €
cajonera doble inox, auto-cierre	double SS drawer, self-closing	453 €
cajonera triple inox, auto-cierre	triple SS drawer, self-closing	676 €
cerradura puerta inox	SS door lock	23 €
cerradura puerta cristal	glass door lock	58 €
motor lado izquierdo	left side motor	69 €
encimera sin peto	worktop without splash-back	0 €
set 4 ruedas	set 4 wheels	93 €
set 6 ruedas	set 6 wheels	139 €
registrador de alarmas HACCP	HACCP alarm recorder	consultar
tropicalizado 43°C	tropicalized 43 °C	consultar
230V 60Hz / 115V 60Hz	230V 60Hz / 115V 60Hz	consultar
respaldo inox	SS rear side	consultar

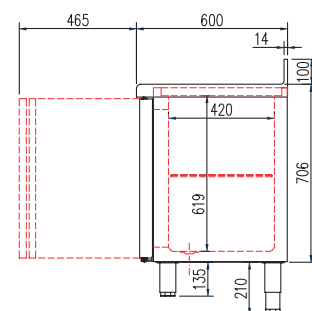



MRSV-200

sin peto opcional
optinal, no splash-back





MRSP-120	1.761 €
MCSP-120	1.940 €



MRSP-170	2.192 €
MCSP-170	2.412 €



MRSP-220	2.539 €
MCSP-220	2.777 €



MRSP-270	3.012 €
----------	---------



MRSPV-120	2.057 €
MCSPV-120	2.361 €



MRSPV-170	2.623 €
MCSPV-170	3.029 €



MRSPV-220	3.095 €
MCSPV-220	3.582 €



MRSPV-270	3.707 €
-----------	---------

Evaporador diseñado para operar con gases HC o HFC - Evaporator designed to operate with HC o HFC gases

mod.	rango range °C	largo length (mm)	alto height (mm)	fondo depth (mm)	estantes shelves	pares guías slides sets	volumen capacity (L)	voltaje voltage	potencia frig. frig. power
MRSP/MRSPV-120	-2°C +8°C	1195	850	600	2	0	246	230V-50Hz	300
MRSP/MRSPV-170	-2°C +8°C	1720	850	600	3	0	380	230V-50Hz	356
MRSP/MRSPV-220	-2°C +8°C	2245	850	600	4	0	516	230V-50Hz	485
MRSP/MRSPV-270	-2°C +8°C	2770	850	600	5	0	651	230V-50Hz	485
MCSP/MCSPV-120	-20°C -15°C	1195	850	600	2	0	245	230V-50Hz	353
MCSP/MCSPV-170	-20°C -15°C	1720	850	600	3	0	380	230V-50Hz	452
MCSP/MCSPV-220	-20°C -15°C	2245	850	600	4	0	516	230V-50Hz	610

Características técnicas y constructivas sujetas a variación sin previo aviso.

We reserve the right to change specifications without prior notice.

- **MRSP / MCSP:** contrapuerta inox embutida
- **MRSPV / MCSPV:** doble cristal + LEDs
- Exterior en acero inox AISI-304, excepto el respaldo
- Interior en acero inox AISI-304, con aristas curvas y fondo embutido
- Puertas de apertura reversible, con sistema de cierre automático y burlete magnético (permanece abierta al superar los 90° de apertura)
- Encimera de acero inox AISI-304 con frente curvo y peto trasero sanitario de 100 mm (opcional sin peto)
- Estantes interiores de alambre en acero plastificado, regulables en altura, sobre apoyos inox
- Pies en tubo de acero inox ajustables en altura 135 - 210 mm
- Evaporador sistema tiro forzado, con recubrimiento epoxi anticorrosión
- Aislamiento de poliuretano inyectado, densidad 40 Kg/m³, cero efectos ODP y GWP
- Control digital de temperatura, descarches optimizados, alarma por alta temperatura de condensación (opcional). Eficiente gestión del consumo de energía
- Unidad condensadora **NO INCLUIDA**
- Control de expansión de refrigerante **NO INCLUIDO**
- Rendimiento del evaporador con $\Delta t = 12^\circ\text{C}$
- Condiciones de trabajo: MRSP 40°C MCSP/MRSPV/MCSPV 32°

- **MRSP / MCSP:** inner side of doors by stamped steel
- **MRSPV / MCSPV:** double glazed doors + LEDs
- AISI-304 stainless steel exterior, rear side galvanized panel
- AISI-304 stainless steel interior, stamped bottom and rounded corners
- Doors with self closing system, blocked opening, magnetic gasket and possibility of changing the opening sense
- AISI-304 stainless steel worktop, with rounded front and 100 mm sanitary upstand (optional without upstand)
- Shelves made of plasticized steel wire, height adjustable by stainless steel supports
- AISI -304 adjustable legs, 135 to 210 mm
- Fan assisted evaporator, with epoxi anticorrosion coating.
- Insulation by free CFC's injected polyurethane with density 40 Kg/m³
- 40 Kg/m³ density polyurethane insulation, zero ODP and GWP
- Digital temperature control, optimized defrost, high-temperature condensation alarm (optional). Efficient management of energy consumption
- Condenser unit **NOT INCLUDED**
- Refrigerant expansion control, **NOT INCLUDED**
- Performance of the evaporator with $\Delta t = 12^\circ\text{C}$
- Operating: MRSP 40°C MCSP/MRSPV/MCSPV 32° ambient

OPCIONES	OPTIONS	€
Parrilla adicional	additional grill	23 €
Cajonera doble inox, auto-cierre	double SS drawer, self-closing	453 €
Cajonera triple inox, auto-cierre	triple SS drawer, self-closing	676 €
Cerradura puerta inox	SS door lock	23 €
Cerradura puerta cristal	glass door lock	58 €
Motor lado izquierdo	left side motor	69 €
Encimera sin peto	worktop without splash-back	0 €
set 4 ruedas	set 4 wheels	93 €
set 6 ruedas	set 6 wheels	139 €
registrador de alarmas HACCP	HACCP alarm recorder	consultar
tropicalizado 43°C	tropicalized 43 ° C	consultar
230V 60Hz / 115V 60Hz	230V 60Hz / 115V 60Hz	consultar
respaldo inox	SS rear side	consultar
evaporación automática	automatic evaporation	110 €

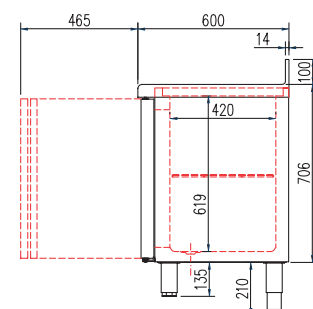



MRSP-220
Conexiones lado izquierdo (opcional)
Left side connections (optional)



MRSPV-170





MRG-150	2.464 €
MRGF-150	2.706 €
MCG-150	3.229 €

MRG-200	2.923 €
MRGF-200	3.179 €
MCG-200	3.791 €

MRG-250	3.467 €
MRGF-250	3.638 €

MRG-300	3.907 €
MRGF-300	4.239 €

mod.	rango range °C	largo length (mm)	alto height (mm)	fondo depth (mm)	estantes shelves GN 1/1	pares guías slides sets	volumen capacity (L)	voltaje voltage	refrigerante refrigerant	potencia frig. frig. power W	potencia power W	CCE EEC 2015/1094 EN16825	clase climate 2015/1094 EN16825
MRG-150	-2°C +8°C	1345	850	700	2	2	255	230V-50Hz	R134a*	178	211	-	5 40°C 40%
									R290	502	235	B	5 40°C 40%
MRG-200	-2°C +8°C	1795	850	700	3	3	399	230V-50Hz	R134a*	245	249	-	5 40°C 40%
									R290	502	238	B	5 40°C 40%
MRG-250	-2°C +8°C	2245	850	700	4	4	543	230V-50Hz	R134a*	304	289	-	5 40°C 40%
									R290	845	340	C	5 40°C 40%
MRG-300	-2°C +8°C	2695	850	700	5	5	686	230V-50Hz	R134a*	356	304	-	5 40°C 40%
									R290	845	355	C	5 40°C 40%
MCG-150	-20°C -15°C	1345	850	700	2	2	255	230V-50Hz	R290	606	535	D	5 40°C 40%
									R449A*	353	556	-	4 30°C 55%
MCG-200	-20°C -15°C	1795	850	700	3	3	399	230V-50Hz	R290	606	556	D	4 30°C 55%
									R449A*	452	610	-	4 30°C 55%

* no disponible mercado UE - not for EU market

Características técnicas y constructivas sujetas a variación sin previo aviso.

We reserve the right to change specifications without prior notice.

- Exterior en acero inox AISI-304, excepto el respaldo
- Interior en acero inox AISI-304, con aristas curvas y fondo embutido
- Puertas de apertura reversible, con sistema de cierre automático y burlete magnético (permanece abierta al superar los 90° de apertura)
- Contrapuerta inox embutida
- Encimera de acero inox AISI-304 con frente curvo y peto trasero sanitario de 100 mm (opcional sin peto)
- Estantes interiores GN 1/1 de alambre en acero plastificado, regulables en altura
- Pies en tubo de acero inox ajustables en altura 135 - 210 mm
- Unidad condensadora ventilada y extraíble
- Evaporador sistema tiro forzado, con recubrimiento epoxi anticorrosión
- Evaporación automática del agua de descarche
- Aislamiento de poliuretano inyectado, densidad 40 Kg/m³, cero efectos ODP y GWP
- Control digital de temperatura, descarches optimizados, alarma por alta temperatura de condensación. Eficiente gestión del consumo de energía
- Condiciones de trabajo: MRG/MRGF 40°C MCG 32°C ambiente

- AISI-304 stainless steel exterior, rear side galvanized panel
- AISI-304 stainless steel interior, stamped bottom and rounded corners
- Doors with self closing system, blocked opening, magnetic gasket and possibility of changing the opening sense
- Inner side of doors by stamped steel
- AISI-304 stainless steel worktop, with rounded front and 100 mm sanitary upstand (optional without upstand)
- GN 1/1 shelves made of plasticized steel wire, height adjustable
- AISI -304 adjustable legs, 135 to 210 mm
- Removable and fan assisted condenser unit
- Fan assisted evaporator, with epoxi anticorrosion coating.
- Automatic evaporation of defrost water
- 40 Kg/m³ density polyurethane insulation, zero ODP and GWP
- Digital temperature control, optimized defrost, high-temperature condensation alarm. Efficient management of energy consumption
- Operating: MRG/MRGF 40°C MCG 32°C ambient

OPCIONES	OPTIONS	€
parrilla suplemento	grill supplement	20 €
parrilla adicional GN-1/1	additional grill GN-1/1	26 €
set adicional guías GN-1/1	additional set GN-1/1 guides	28 €
cambio R290 por R134a	change R290 for R134a	0 €
cambio R290 por R449A	change R290 for R449A	0 €
cajonera doble inox, auto-cierre	double SS drawer, self-closing	570 €
cajonera triple inox, auto-cierre	triple SS drawer, self-closing	752 €
cerradura puerta inox	SS door lock	23 €
cerradura puerta cristal	glass door lock	58 €
motor lado izquierdo	left side motor	69 €
encimera sin peto	worktop without splash-back	0 €
set 4 ruedas	set 4 wheels	93
set 6 ruedas	set 6 wheels	139 €
registrador de alarmas HACCP	HACCP alarm recorder	consultar
tropicalizado 43°C	tropicalized 43 °C	consultar
230V 60Hz / 115V 60Hz	230V 60Hz / 115V 60Hz	consultar
respaldo inox	SS rear side	consultar

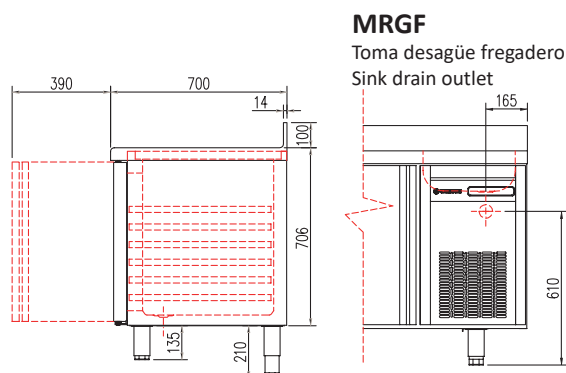



Mesa fría GN 1/1, refrigeración y congelados

GN 1/1 chiller and freezer counter



MRG-200

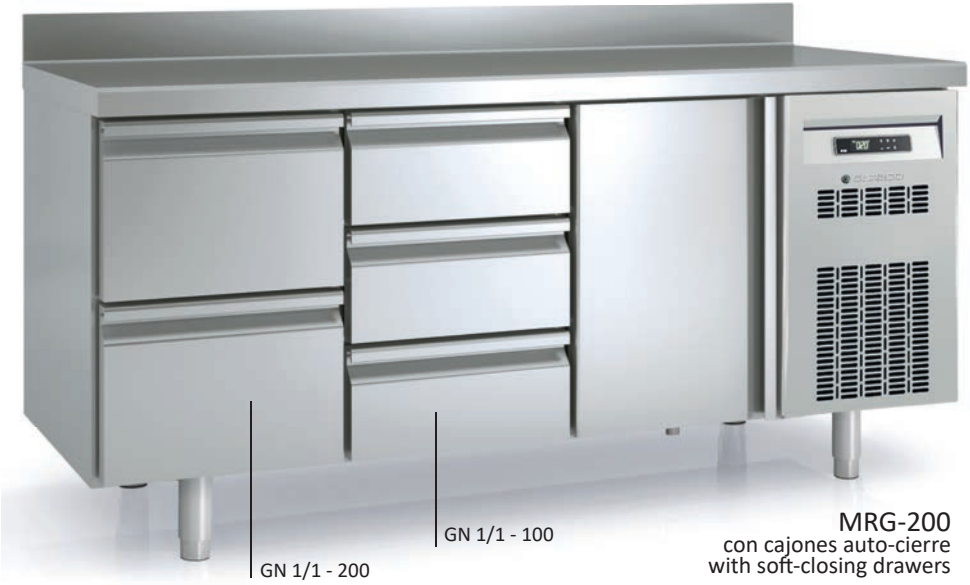

GN 1/1 - 200

GN 1/1 - 100

MRG-200 con cajones auto-cierre with soft-closing drawers

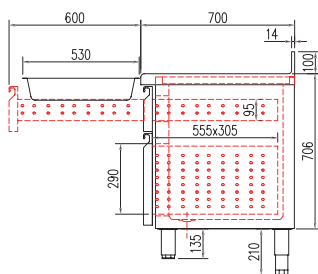
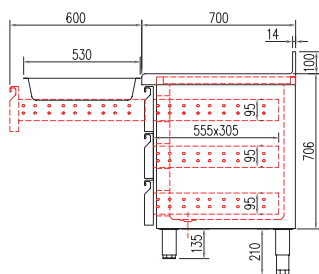
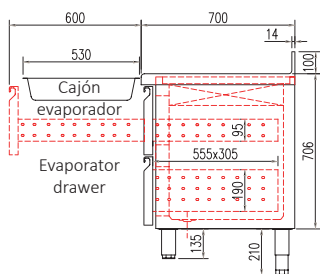
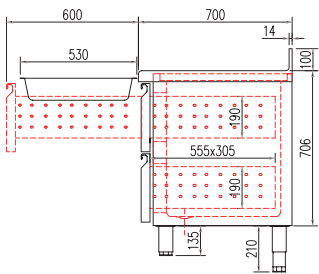
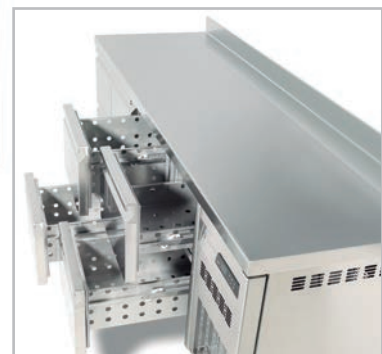

sin peto opcional
optinal, no splash-back



MRGF

Fregadero 340 x 360 x 160
340 x 360 x 160 Sink



MRGV-150	2.840 €
MCGV-150	3.630 €

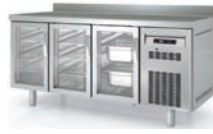

MRGV-200	3.430 €
MCGV-200	4.386 €



MRGV-250	4.115 €
MCGV-250	5.194 €



MRGV-300	4.742 €
----------	---------

mod.	rango range °C	largo length (mm)	alto height (mm)	fondo depth (mm)	estantes shelves GN 1/1	pares guías slides sets	volumen capacity (L)	voltaje voltage	refrigerante refrigerant	potencia frig. frig. power W	potencia power W	CCE EEC 2015/1094 EN16825	clase climate 2015/1094 EN16825
MRGV-150	-2°C +8°C	1345	850	700	2	2	255	230V-50Hz	R134a*	304	351	-	4 30°C 55%
									R290	502	240	B	5 40°C 40%
MRGV-200	-2°C +8°C	1795	850	700	3	3	399	230V-50Hz	R134a*	304	367	-	4 30°C 55%
									R290	502	246	B	5 40°C 40%
MRGV-250	-2°C +8°C	2245	850	700	4	4	543	230V-50Hz	R134a*	485	441	-	4 30°C 55%
									R290	845	352	C	5 40°C 40%
MRGV-300	-2°C +8°C	2695	850	700	5	5	686	230V-50Hz	R134a*	485	444	-	4 30°C 55%
									R290	845	369	C	5 40°C 40%
MCGV-150	-20°C -15°C	1345	850	700	2	2	255	230V-50Hz	R290	606	540	D	4 30°C 55%
									R449A*	353	561	-	4 30°C 55%
MCGV-200	-20°C -15°C	1795	850	700	3	3	399	230V-50Hz	R290	606	544	D	4 30°C 55%
									R449A*	452	619	-	4 30°C 55%

* no disponible mercado UE - not for EU market

Características técnicas y constructivas sujetas a variación sin previo aviso.

We reserve the right to change specifications without prior notice.

- Exterior en acero inox AISI-304, excepto el respaldo
- Interior en acero inox AISI-304, con aristas curvas y fondo embutido
- Puertas de apertura reversible, con sistema de cierre automático y burlete magnético (permanece abierta al superar los 90° de apertura)
- Puertas doble cristal + LEDs
- Encimera de acero inox AISI-304 con frente curvo y peto trasero sanitario de 100 mm (opcional sin peto)
- Estantes interiores GN 1/1 de alambre en acero plastificado, regulables en altura
- Pies en tubo de acero inox ajustables en altura 135 - 210 mm
- Unidad condensadora ventilada y extraíble
- Evaporador sistema tiro forzado, con recubrimiento epoxi anticorrosión
- Evaporación automática del agua de descarche
- Aislamiento de poliuretano inyectado, densidad 40 Kg/m³, cero efectos ODP y GWP
- Control digital de temperatura, descarches optimizados, alarma por alta temperatura de condensación. Eficiente gestión del consumo de energía
- Condiciones de trabajo: 32°C ambiente

- AISI-304 stainless steel exterior, rear side galvanized panel
- AISI-304 stainless steel interior, stamped bottom and rounded corners
- Doors with self closing system, blocked opening, magnetic gasket and possibility of changing the opening sense
- Double glazed doors + LEDs
- AISI-304 stainless steel worktop, with rounded front and 100 mm sanitary upstand (optional without upstand)
- GN 1/1 shelves made of plasticized steel wire, height adjustable
- AISI-304 adjustable legs, 135 to 210 mm
- Removable and fan assisted condenser unit
- Fan assisted evaporator, with epoxi anticorrosion coating.
- Automatic evaporation of defrost water
- 40 Kg/m³ density polyurethane insulation, zero ODP and GWP
- Digital temperature control, optimized defrost, high-temperature condensation alarm. Efficient management of energy consumption
- Operating: 32°C ambient

OPCIONES	OPTIONS	€
parrilla suplemento	grill supplement	20 €
parrilla adicional GN-1/1	additional grill GN-1/1	26 €
set adicional guías GN-1/1	additional set GN-1/1 guides	28 €
cambio R290 por R134a	change R290 for R134a	0 €
cambio R290 por R449A	change R290 for R449A	0 €
cajonera doble inox, auto-cierre	double SS drawer, self-closing	570 €
cajonera triple inox, auto-cierre	triple SS drawer, self-closing	752 €
cerradura puerta inox	SS door lock	23 €
cerradura puerta cristal	glass door lock	58 €
motor lado izquierdo	left side motor	69 €
encimera sin peto	worktop without splash-back	0 €
set 4 ruedas	set 4 wheels	93 €
set 6 ruedas	set 6 wheels	139 €
registrador de alarmas HACCP	HACCP alarm recorder	consultar
tropicalizado 43°C	tropicalized 43 °C	consultar
230V 60Hz / 115V 60Hz	230V 60Hz / 115V 60Hz	consultar
respaldo inox	SS rear side	consultar

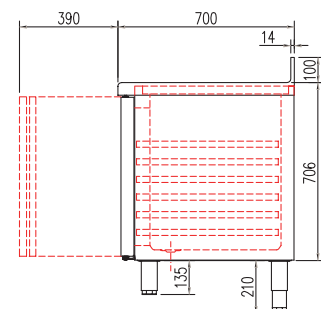



MRGV-250
dotación parrillas y contenedores extra
with extra containers and shelves

sin peto opcional
optinal, no splash-back





MRGP-120	1.876 €
MCGP-120	2.036 €



MRGP-170	2.259 €
MCGP-170	2.438 €



MRGP-220	2.744 €
MCGP-220	2.860 €



MRGP-270	3.179 €
----------	---------



MRGPV-120	2.181 €
MCGPV-120	2.450 €



MRGPV-170	2.690 €
MCGPV-170	3.055 €



MRGPV-220	3.301 €
MCGPV-220	3.667 €



MRGPV-270	3.877 €
-----------	---------

Evaporador diseñado para operar con gases HC o HFC - Evaporator designed to operate with HC o HFC gases

mod.	rango range °C	largo length (mm)	alto height (mm)	fondo depth (mm)	estantes shelves GN 1/1	pares guías slides sets	volumen capacity (L)	voltaje voltage	potencia frig. frig. power
MRGP / MRGPV-120	-2°C +8°C	1045	850	700	2	2	255	230V-50Hz	300
MRGP / MRGPV-170	-2°C +8°C	1495	850	700	3	3	399	230V-50Hz	356
MRGP / MRGPV-220	-2°C +8°C	1945	850	700	4	4	543	230V-50Hz	485
MRGP / MRGPV-270	-2°C +8°C	2395	850	700	5	5	686	230V-50Hz	485
MCGP / MCGPV-120	-20°C -15°C	1045	850	700	2	2	255	230V-50Hz	353
MCGP / MCGPV-170	-20°C -15°C	1495	850	700	3	3	399	230V-50Hz	452
MCGP / MCGPV-220	-20°C -15°C	1945	850	700	4	4	543	230V-50Hz	610

Características técnicas y constructivas sujetas a variación sin previo aviso.

We reserve the right to change specifications without prior notice.

- **MRGP / MCGP:** Contrapuerta inox embutida
- **MRGPV / MCGPV:** doble cristal + LEDs

- **MRGP / MCGP:** inner side of doors by stamped steel
- **MRGPV / MCGPV:** double glazed doors + LEDs

- Exterior en acero inox AISI-304, excepto el respaldo
- Interior en acero inox AISI-304, con aristas curvas y fondo embutido
- Puertas de apertura reversible, con sistema de cierre automático y burlete magnético (permanece abierta al superar los 90° de apertura)
- Encimera de acero inox AISI-304 con frente curvo y peto trasero sanitario de 100 mm (opcional sin peto)
- Estantes interiores GN 1/1 de alambre en acero plastificado, regulables en altura
- Pies en tubo de acero inox ajustables en altura 135 - 210 mm
- Unidad condensadora **NO INCLUIDA**
- Control de expansión de refrigerante **NO INCLUIDO**
- Rendimiento del evaporador con $\Delta t=12^{\circ}\text{C}$
- Evaporador sistema tiro forzado, con recubrimiento epoxi anticorrosión
- Aislamiento de poliuretano inyectado, densidad 40 Kg/m³, cero efectos ODP y GWP
- Control digital de temperatura, descarches optimizados, alarma por alta temperatura de condensación (opcional). Eficiente gestión del consumo de energía
- Condiciones de trabajo: MRGP / MCGP 40°C ambiente
MRGPV / MCGPV 32°C ambiente

- AISI-304 stainless steel exterior, rear side galvanized panel
- AISI-304 stainless steel interior, stamped bottom and rounded corners
- Doors with self closing system, blocked opening, magnetic gasket and possibility of changing the opening sense
- AISI-304 stainless steel worktop, with rounded front and 100 mm sanitary upstand (optional without upstand)
- GN 1/1 shelves made of plasticized steel wire, height adjustable
- AISI-304 adjustable legs, 135 to 210 mm
- Condenser unit **NOT INCLUDED**
- Refrigerant expansion control, **NOT INCLUDED**
- Performance of the evaporator with $Dt = 12^{\circ}\text{C}$
- Fan assisted evaporator, with epoxi anticorrosion coating.
- 40 Kg/m³ density polyurethane insulation, zero ODP and GWP
- Digital temperature control, optimized defrost, high-temperature condensation alarm (optional). Efficient management of energy consumption
- Operating: MRG / MCG 40°C ambient
MRGV / MCGV 32°C ambient

OPCIONES	OPTIONS	€
parrilla suplemento	grill supplement	20 €
parrilla adicional GN-1/1	additional grill GN-1/1	26 €
set adicional guías GN-1/1	additional set GN-1/1 guides	28 €
cajonera doble inox, auto-cierre	double SS drawer, self-closing	570 €
cajonera triple inox, auto-cierre	triple SS drawer, self-closing	752 €
cerradura puerta inox	SS door lock	23 €
cerradura puerta cristal	glass door lock	58 €
motor lado izquierdo	left side motor	69 €
encimera sin peto	worktop without splash-back	0 €
set 4 ruedas	set 4 wheels	93 €
set 6 ruedas	set 6 wheels	139 €
registrador de alarmas HACCP	HACCP alarm recorder	consultar
tropicalizado 43°C	tropicalized 43 °C	consultar
230V 60Hz / 115V 60Hz	230V 60Hz / 115V 60Hz	consultar
respaldo inox	SS rear side	consultar
evaporación automática	automatic evaporation	110 €

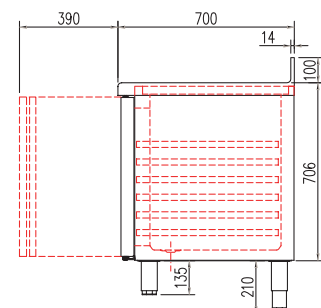



MRGP-220



MRGPV-220





MRP-150	2.744 €
MCP-150	3.403 €



MRP-200	3.281 €
MCP-200	3.984 €



MRP-250	3.958 €
---------	---------



MRPV-150	3.137 €
MCPV-150	3.814 €



MRPV-200	3.853 €
MCPV-200	4.577 €



MRPV-250	4.668 €
MCPV-250	5.096 €

mod.	rango range °C	largo length (mm)	alto height (mm)	fondo depth (mm)	estantes shelves 40x60	pares guías slides sets	volumen capacity (L)	voltaje voltage	refrigerante refrigerant	potencia frig. frig. power W	potencia power W	CCE EEC 2015/1094 EN16825	clase climate 2015/1094 EN16825
MRP-150	-2°C +8°C	1495	850	800	0	10	362	230V-50Hz	R134a*	178	211	-	5 40°C 40%
									R290	502	235	A	5 40°C 40%
MRP-200	-2°C +8°C	2020	850	800	0	15	562	230V-50Hz	R134a*	245	249	-	5 40°C 40%
									R290	502	238	A	5 40°C 40%
MRP-250	-2°C +8°C	2545	850	800	0	20	761	230V-50Hz	R134a*	304	289	-	5 40°C 40%
									R290	845	370	B	5 40°C 40%
MRPV-150	-2°C +8°C	1495	850	800	0	10	362	230V-50Hz	R134a*	304	295	-	4 30°C 55%
									R290	502	244	C	4 30°C 55%
MRPV-200	-2°C +8°C	2020	850	800	0	15	562	230V-50Hz	R134a*	304	302	-	4 30°C 55%
									R290	502	251	C	4 30°C 55%
MRPV-250	-2°C +8°C	2545	850	800	0	20	761	230V-50Hz	R134a*	485	446	-	4 30°C 55%
									R290	845	358	D	4 30°C 55%
MCP-150	-20°C -15°C	1495	850	800	0	10	362	230V-50Hz	R290	606	535	E	5 40°C 40%
									R449A*	353	552	-	4 30°C 55%
MCP-200	-20°C -15°C	2020	850	800	0	15	562	230V-50Hz	R290	606	556	E	4 30°C 55%
									R449A*	452	610	-	4 30°C 55%
MCPV-150	-20°C -15°C	1495	850	800	0	10	362	230V-50Hz	R290	606	544	E	4 30°C 55%
									R449A*	353	518	-	4 30°C 55%
MCPV-200	-20°C -15°C	2020	850	800	0	15	562	230V-50Hz	R290	606	569	E	4 30°C 55%
									R449A*	452	681	-	4 30°C 55%

* no disponible mercado UE - not for EU market

Características técnicas y constructivas sujetas a variación sin previo aviso.

- Exterior en acero inox AISI-304, excepto el respaldo
- Interior en acero inox AISI-304, con aristas curvas y fondo embutido
- Puertas de apertura reversible, con sistema de cierre automático y burlete magnético (permanece abierta al superar los 90° de apertura)
- Contrapuerta inox embutida
- Encimera de acero inox AISI-304 con frente curvo (opcional con peto)
- Pies en tubo de acero inox ajustables en altura 135 - 210 mm
- Unidad condensadora ventilada y extraíble
- Evaporador sistema tiro forzado, con recubrimiento epoxi anticorrosión
- Evaporación automática del agua de descarche
- Aislamiento de poliuretano inyectado, 40 Kg/m³, cero efectos ODP y GWP
- Control digital de temperatura, descarches optimizados, alarma por alta temperatura de condensación. Eficiente gestión del consumo de energía
- Temperatura ambiente de trabajo: MRP / MCP 40°C
MRPV / MCPV 32°C

We reserve the right to change specifications without prior notice.

- AISI-304 stainless steel exterior, rear side galvanized panel
- AISI-304 stainless steel interior, stamped bottom and rounded corners
- Doors with self closing system, blocked opening, magnetic gasket and possibility of changing the opening sense
- Inner side of doors by stamped steel
- AISI-304 stainless steel worktop, with rounded front (optional with upstand)
- AISI -304 adjustable legs, 135 to 210 mm
- Removable and fan assisted condenser unit
- Fan assisted evaporator, with epoxi anticorrosion coating.
- Automatic evaporation of defrost water
- 40 Kg/m³ density polyurethane insulation, zero ODP and GWP
- Digital temperature control, optimized defrost, high-temperature condensation alarm. Efficient management of energy consumption
- Operating ambient temperature: MRP / MCP 40°C
MRPV / MCPV 32°C

OPCIONES	OPTIONS	€
parrilla suplemento	grill supplement	26 €
parrilla 60x40	grill 60x40	26 €
set adicional guías 60x40	additional set guides 60x40	22 €
cambio R290 por R134a	change R290 for R134a	0 €
cambio R290 por R449A	change R290 for R449A	0 €
cerradura puerta inox	SS door lock	23 €
cerradura puerta cristal	glass door lock	58 €
motor lado izquierdo	left side motor	69 €
encimera con peto	worktop with splash-back	0 €
set 4 ruedas	set 4 wheels	93 €
set 6 ruedas	set 6 wheels	139 €
registrador de alarmas HACCP	HACCP alarm recorder	consultar
tropicalizado 43°C	tropicalized 43 °C	consultar
230V 60Hz / 115V 60Hz	230V 60Hz / 115V 60Hz	consultar
respaldo inox	SS rear side	consultar
encimera de granito	granite countertop	consultar
exterior color blanco	white exterior	consultar

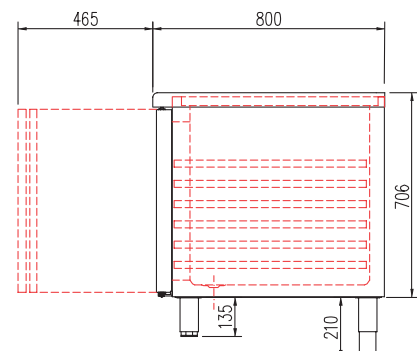



Mesa fría 60x40, refrigeración y congelados
60x40 chiller and freezer counter



MRPV-250
dotación parillas extra
with extra shelves



MRP-250

Encimera granito opcional
Optional granite worktop



MRP-200 exterior blanco opcional
MRP-200 option white exterior



MRPP-120	2.054 €
MCPP-120	2.252 €



MRPP-170	2.585 €
MCPP-170	2.842 €



MRPP-220	3.122 €
MCPP-220	3.193 €



MRPPV-120	2.372 €
MCPPV-120	2.684 €



MRPPV-170	3.050 €
MCPPV-170	3.470 €



MRPPV-220	3.701 €
MCPPV-220	4.017 €

Evaporador diseñado para operar con gases HC o HFC - Evaporator designed to operate with HC o HFC gases

mod.	rango range °C	largo length (mm)	alto height (mm)	fondo depth (mm)	estantes shelves 40x60	pares guías slides sets	volumen capacity (L)	voltaje voltage	potencia frig. frig. power
MRPP / MRPPV-120	-2°C +8°C	1195	850	800	0	10	255	230V-50Hz	304
MRPP / MRPPV-170	-2°C +8°C	1720	850	800	0	15	399	230V-50Hz	356
MRPP / MRPPV-220	-2°C +8°C	2245	850	800	0	20	543	230V-50Hz	485
MCPP / MCPPV-120	-20°C -15°C	1195	850	800	0	10	255	230V-50Hz	353
MCPP / MCPPV-170	-20°C -15°C	1720	850	800	0	15	399	230V-50Hz	452
MCPP / MCPPV-220	-20°C -15°C	2245	850	800	0	20	543	230V-50Hz	610

Características técnicas y constructivas sujetas a variación sin previo aviso.

- MRPP / MCPP Contrapuerta inox embutida
- MRPPV / MCPPV doble cristal + LEDs
- Exterior en acero inox AISI-304, excepto el respaldo
- Interior en acero inox AISI-304, con aristas curvas y fondo embutido
- Puertas de apertura reversible, con sistema de cierre automático y burlete magnético (permanece abierta al superar los 90° de apertura)
- Encimera de acero inox AISI-304 con frente curvo (Opcional con peto sanitario 100 mm)
- Interior con guías de acero inox, regulables en altura para parrillas, bandejas o contenedores 60x40
- Pies en tubo de acero inox ajustables en altura 135 - 210 mm
- Evaporador sistema tiro forzado, con recubrimiento epoxi anticorrosión
- Aislamiento de poliuretano inyectado, densidad 40 Kg/m³, cero efectos ODP y GWP
- Control digital de temperatura, descarches optimizados, alarma por alta temperatura de condensación (MRPP MCPP). Eficiente gestión del consumo de energía
- Unidad condensadora **NO INCLUIDA**
- Control de expansión de refrigerante **NO INCLUIDO**
- Rendimiento del evaporador con Δt=12°C
- Condiciones de trabajo: MRPP / MCPP 40°C ambiente
MRPPV / MCPPV 32°C ambiente

We reserve the right to change specifications without prior notice.

- MRPP / MCPP inner side of doors by stamped steel
- MRPPV / MCPPV double glazed doors + LEDs
- AISI-304 stainless steel exterior, rear side galvanized panel
- AISI-304 stainless steel interior, stamped bottom and rounded corners
- Doors with self closing system, blocked opening, magnetic gasket and possibility of changing the opening sense
- AISI-304 stainless steel worktop, with rounded front (optional with 100 mm sanitary upstand)
- Capacity for 60x40 shelves, containers or trays by stainless steel slides, height adjustable
- AISI -304 adjustable legs, 135 to 210 mm
- Fan assisted evaporator, with epoxi anticorrosion coating.
- 40 Kg/m³ density polyurethane insulation, zero ODP and GWP
- Digital temperature control, optimized defrost, high-temperature condensation alarm (MRPP MCPP). Efficient management of energy consumption
- Condenser unit **NOT INCLUDED**
- Refrigerant expansion control, **NOT INCLUDED**
- Performance of the evaporator with Δt = 12 °C
- Operating: MRPP / MCPP 40°C ambient
MRPPV / MCPPV 32°C ambient

OPCIONES	OPTIONS	€
parrilla suplemento	grill supplement	26 €
parrilla 60x40	grill 60x40	26 €
set adicional guías 60x40	additional set guides 60x40	22 €
cerradura puerta inox	SS door lock	0 €
cerradura puerta cristal	glass door lock	0 €
motor lado izquierdo	left side motor	23 €
encimera con peto	worktop with splash-back	58 €
set 4 ruedas	set 4 wheels	69 €
set 6 ruedas	set 6 wheels	0 €
registrador de alarmas HACCP	HACCP alarm recorder	93 €
tropicalizado 43°C	tropicalized 43 °C	139 €
230V 60Hz / 115V 60Hz	230V 60Hz / 115V 60Hz	consultar
respaldo inox	SS rear side	consultar
encimera de granito	granite countertop	consultar
exterior color blanco	white exterior	consultar
evaporación automática	automatic evaporation	110 €

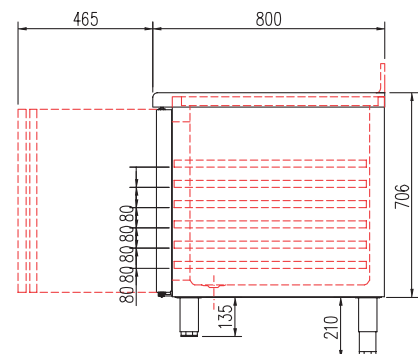



MRPP-220



MRPPV-220
con parrillas extra
with extra shelves





TSR-150-S	1.832 €
TSC-150-S	2.368 €



TSR-200-S	2.192 €
TSC-200-S	2.751 €



TSR-250-S	2.592 €
-----------	---------



TSRV-150-S	2.005 €
------------	---------



TSRV-200-S	2.438 €
------------	---------



TSRV-250-S	2.923 €
------------	---------

mod.	rango range °C	largo length (mm)	alto height (mm)	fondo depth (mm)	estantes shelves	volumen capacity (L)	voltaje voltage	refrigerante refrigerant	potencia frig. frig. power W	potencia power W	CCE EEC 2015/1094 EN16825	clase climate 2015/1094 EN16825
TSR-150-S	-2°C +8°C	1495	850	600	2	245	230V-50Hz	R134a* R290	178 502	211 235	- B	5 40°C 40% 5 40°C 40%
TSR-200-S	-2°C +8°C	2020	850	600	3	380	230V-50Hz	R134a* R290	245 502	249 238	- B	5 40°C 40% 5 40°C 40%
TSR-250-S	-2°C +8°C	2545	850	600	4	516	230V-50Hz	R134a* R290	304 845	289 379	- C	5 40°C 40% 5 40°C 40%
TSRV-150-S	-2°C +8°C	1495	850	600	2	245	230V-50Hz	R134a* R290	178 502	220 244	- C	4 30°C 55% 5 40°C 40%
TSRV-200-S	-2°C +8°C	2020	850	600	3	380	230V-50Hz	R134a* R290	245 502	255 251	- D	4 30°C 55% 5 40°C 40%
TSRV-250-S	-2°C +8°C	2545	850	600	4	516	230V-50Hz	R134a* R290	304 845	307 397	- D	4 30°C 55% 5 40°C 40%
TSC-150-S	-20°C -15°C	1495	850	600	2	245	230V-50Hz	R290 R449A*	606 353	535 556	- E	5 40°C 40% 4 30°C 55%
TSC-200-S	-20°C -15°C	2020	850	600	3	380	230V-50Hz	R290 R449A*	606 452	556 610	- E	4 30°C 55% 4 30°C 55%

* no disponible mercado UE - not for EU market

características técnicas y constructivas sujetas a variación sin previo aviso

- Exterior en acero inox AISI-304, respaldo en chapa galvanizada
- Interior en acero inox AISI-304, con aristas curvas y fondo embutido
- Puertas de apertura reversible, con sistema de cierre automático y burlete magnético (permanece abierta al superar los 90° de apertura)
- TSRV: puerta doble cristal + LEDs
- Encimera con peto trasero sanitario de 100 mm
- Estantes interiores de alambre en acero plastificado, regulables en altura
- Pies en tubo de acero inox ajustables en altura 135 - 210 mm
- Unidad condensadora ventilada y extraíble
- Evaporador sistema tiro forzado, con recubrimiento epoxi anticorrosión
- Evaporación automática del agua de descarche
- Aislamiento de poliuretano inyectado, densidad 40 Kg/m³, cero efectos ODP y GWP
- Control digital de temperatura, descarches optimizados, alarma por alta temperatura de condensación. Eficiente gestión del consumo de energía
- Temperatura de trabajo: TRS 40°C ambiente
TSC/TSRV 32°C ambiente

we reserve the right to change specifications without prior notice

- AISI-304 stainless steel exterior, rear side in galvanized panel
- AISI-304 stainless steel interior, rounded corners and stamped bottom
- Doors with self closing system, blocked opening, magnetic gasket and possibility of changing the opening sense
- TSRV: double glazed door + LEDs lighting
- Worktop, with 100 mm sanitary upstand
- Shelves made of plasticized steel wire, height adjustable
- Stainless steel adjustable legs, 135 to 210 mm
- Removable and fan assisted condenser unit
- Fan assisted evaporator, with epoxi anticorrosion coating.
- Automatic evaporation of defrost water
- 40 Kg/m³ density polyurethane insulation, zero ODP and GWP
- Digital temperature control, optimized defrost, high-temperature condensation alarm. Efficient management of energy consumption
- Operating temperature: TRS 40°C ambient
TSC/TSRV 32°C ambient

OPCIONES	OPTIONS	€
parrilla adicional	additional grill	23 €
cambio R290 por R134a	change R290 for R134a	0 €
cambio R290 por R449A	change R290 for R449A	0 €
set 4 ruedas	set 4 wheels	93 €
set 6 ruedas	set 6 wheels	139 €
TSR cajonera doble inox, auto-cierre	double SS drawer, self-closing for TSR	341 €
encimera sin peto	worktop without splash-back	consultar
230V 60Hz / 115V 60Hz	230V 60Hz / 115V 60Hz	consultar

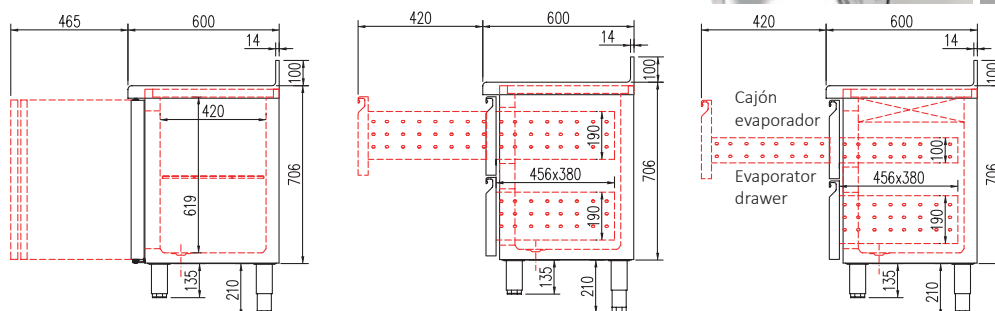



TSRV-150-S



TSR-200-S





TGR-135-S	2.036 €
TGC-135-S	2.744 €



TGR-180-S	2.425 €
TGC-180-S	3.172 €



TGR-225-S	2.853 €
-----------	---------



TGRV-135-S	2.203 €
------------	---------



TGRV-180-S	2.684 €
------------	---------



TGRV-225-S	3.193 €
------------	---------

mod.	rango range °C	largo length (mm)	alto height (mm)	fondo depth (mm)	estantes shelves GN 1/1	pares guías slides sets	volumen capacity (L)	voltaje voltage	refrigerante refrigerant	potencia frig. power W	potencia power W	CCE EEC 2015/1094 EN16825	clase climate 2015/1094 EN16825
TGR-135-S	-2°C +8°C	1345	850	700	2	2	255	230V-50Hz	R134a*	178	211	-	5 40°C 40%
									R290	502	235	B	5 40°C 40%
TGR-180-S	-2°C +8°C	1795	850	700	3	3	399	230V-50Hz	R134a*	245	249	-	5 40°C 40%
									R290	502	238	B	5 40°C 40%
TGR-225-S	-2°C +8°C	2245	850	700	4	4	543	230V-50Hz	R134a*	304	289	-	5 40°C 40%
									R290	845	379	C	5 40°C 40%
TGRV-135-S	-2°C +8°C	1345	850	700	2	2	255	230V-50Hz	R134a*	178	217	-	4 30°C 55%
									R290	502	241	C	5 40°C 40%
TGRV-180-S	-2°C +8°C	1795	850	700	3	3	399	230V-50Hz	R134a*	245	263	-	4 30°C 55%
									R290	502	267	C	5 40°C 40%
TGRV-225-S	-2°C +8°C	2245	850	700	4	4	543	230V-50Hz	R134a*	304	307	-	4 30°C 55%
									R290	845	397	D	5 40°C 40%
TGC-135-S	-20°C -15°C	1345	850	700	2	2	255	230V-50Hz	R290	606	535	E	4 30°C 55%
									R449A*	353	556	-	4 30°C 55%
TGC-180-S	-20°C -15°C	1795	850	700	3	3	399	230V-50Hz	R290	606	556	E	4 30°C 55%
									R449A*	452	610	-	4 30°C 55%

características técnicas y constructivas sujetas a variación sin previo aviso

- Exterior en acero inox AISI-304, respaldo en chapa galvanizada
- Interior en acero inox AISI-304, con aristas curvas y fondo embutido
- Puertas de apertura reversible, con sistema de cierre automático y burlete magnético (permanece abierta al superar los 90° de apertura)
- TGRS: puerta doble cristal + LEDs
- Encimera con peto trasero sanitario de 100 mm
- Estantes interiores GN 1/1 de alambre en acero plastificado, regulables en altura sobre guías inox
- Pies en tubo de acero inox ajustables en altura 135 - 210 mm
- Unidad condensadora ventilada y extraíble
- Evaporador sistema tiro forzado, con recubrimiento epoxi anticorrosión
- Evaporación automática del agua de descarche
- Aislamiento de poliuretano inyectado, densidad 40 Kg/m³, cero efectos ODP y GWP
- Control digital de temperatura, descarches optimizados, alarma por alta temperatura de condensación. Eficiente gestión del consumo de energía
- Temperatura de trabajo: TGR 40°C ambiente
TGC / TGRV 32°C ambiente

* no disponible mercado UE - not for EU market
we reserve the right to change specifications whitout prior notice

- AISI-304 stainless steel exterior, rear side in galvanized panel
- AISI-304 stainless steel interior, rounded corners and stamped bottom
- Doors with self closing system, blocked opening, magnetic gasket and possibility of changing the opening sense
- TGRV: double glazed door + LEDs lighting
- Worktop, with 100 mm sanitary upstand
- GN 1/1 shelves made of plasticized steel wire, height adjustable with stainless steel slides
- Stainless steel adjustable legs, 135 to 210 mm
- Removable and fan assisted condenser unit
- Fan assisted evaporator, with epoxi anticorrosion coating.
- Automatic evaporation of defrost water
- 40 Kg/m³ density polyurethane insulation, zero ODP and GWP
- Digital temperature control, optimized defrost, high-temperature condensation alarm. Efficient management of energy consumption
- Operating temperature: TGR 40°C ambient
TGC / TGRV 32°C ambient

OPCIONES	OPTIONS	€
parrilla adicional GN-1/1	additional grill GN-1/1	20 €
set adicional guías GN-1/1	additional set GN-1/1 guides	28 €
cambio R290 por R134a	change R290 for R134a	0 €
cambio R290 por R449A	change R290 for R449A	0 €
set 4 ruedas	set 4 wheels	93 €
set 6 ruedas	set 6 wheels	139 €
TGR cajonera doble inox, auto-cierre	double SS drawer, self-closing for TGR	375 €
encimera sin peto	worktop without splash-back	consultar
230V 60Hz / 115V 60Hz	230V 60Hz / 115V 60Hz	consultar

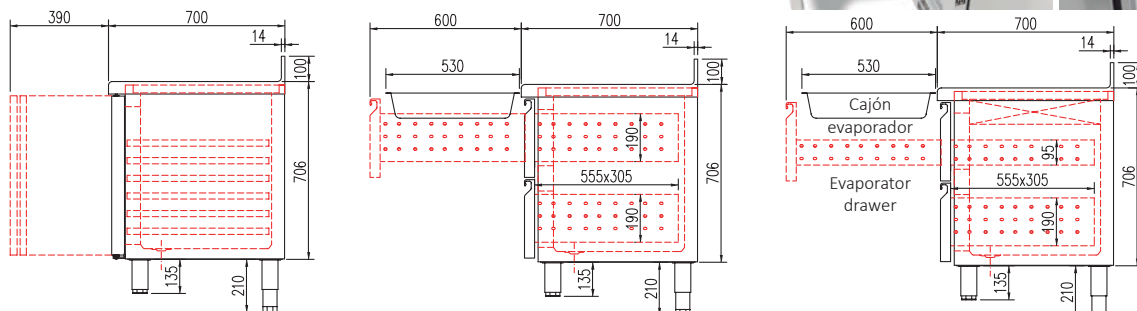



TGRV-180-S



TGR-180-S



TGR-225-S
ruedas y cajones opcionales
with extra drawers and castors

MESAS FRÍO PROFESIONAL



Características generales:

- Control electrónico y digital de la temperatura de desescarche.
- Evaporación automática del agua de desescarche.
- Estante en varilla de acero plastificada (405x460mm - en el centro - y 405x525mm - en los extremos -) con soporte regulable en altura: 1 parrilla por puerta de serie.
- Patas de acero inoxidable regulables en altura.
- Trasera en galvanizado.
- Los Equipos de Grupo a Distancia, no llevan incluido el grupo frigorífico independiente (solicitar cotización para 5m).
- Interior y exterior en acero inoxidable AISI 304.
- Dispositivo automático de cierre.
- Refrigerante R290a en refrigeración y congelación.
- Refrigeración por tiro forzado.
- Tensión de trabajo 230 V-1N-50 Hz.
- Modelos con puerta de cristal:
 - Resistencia en las puertas.
 - Iluminación LED interior.

OPCIONAL

- Mueble tropicalizado.
- Ruedas.
- Fregadero.
- Compresor a la izquierda.
- Kit Cajones.
- Sin encimera o con granito.
- Sin peto.

	Puertas	Rango de temperatura	Vol. neto / cap. útil	Potencia frigorífica	Potencia eléctrica	Consumo energético	Clasif. energética	Peso neto / bruto
	Uds.	°C	L.	W.	W.	Kwh/24h.		Kg.
REFRIGERACIÓN (Temperatura ambiente de 38°C)								
MR15002	2	- 2°C /+ 8°C	255	250	220	2,79	C	98
MR20003	3	- 2°C /+ 8°C	395	250	220	3,06	C	125
MR25004	4	- 2°C /+ 8°C	535	561	349	5,26	D	152
MRV15002	2 Cristal	- 2°C /+ 8°C	255	250	220	-	-	102
MRV20003	3 Cristal	- 2°C /+ 8°C	395	250	220	-	-	131
MRV25004	4 Cristal	- 2°C /+ 8°C	535	561	349	-	-	160
MR15002 D	2	- 2°C /+ 8°C	255	-	29	-	-	78
MR20003 D	3	- 2°C /+ 8°C	395	-	29	-	-	105
MR25004 D	4	- 2°C /+ 8°C	535	-	39	-	-	140
MR15002 TC	0/4	- 2°C /+ 8°C	255	250	220	2,79	C	122
MR20003 TC	0/6	- 2°C /+ 8°C	395	250	220	3,06	C	161
MR25004 TC	0/8	- 2°C /+ 8°C	535	561	349	5,26	E	200
CONGELACIÓN (Temperatura ambiente de 38°C)								
MC15002	2	- 15°C /- 22°C	255	364	669	6,06	D	98
MC20003	3	- 15°C /- 22°C	395	364	679	6,76	D	125

BAJO MOSTRADOR

	Puertas	Rango de temperatura	Vol. neto / cap. útil	Potencia frigorífica	Potencia eléctrica	Consumo energético	Clasif. energética	Peso neto / bruto
	Uds.	°C	L.	W.	W.	Kwh/24h.		Kg.
REFRIGERACIÓN (Temperatura ambiente de 38°C)								
FR15002	2	- 2°C /+ 8°C	333	250	220	3,27	D	131
FR20003	3	- 2°C /+ 8°C	517	250	220	3,06	C	158
FR25004	4	- 2°C /+ 8°C	701	561	349	5,26	D	185
FRV15002	2 Cristal	- 2°C /+ 8°C	333	250	220	-	-	131
FRV20003	3 Cristal	- 2°C /+ 8°C	517	250	220	-	-	158
FRV25004	4 Cristal	- 2°C /+ 8°C	701	561	349	-	-	185
FR15002 D	2	- 2°C /+ 8°C	333	-	29	-	-	111
FR20003 D	3	- 2°C /+ 8°C	517	-	29	-	-	138
FR25004 D	4	- 2°C /+ 8°C	701	-	29	-	-	165

FRENTE MOSTRADOR

MR: Refrigeración MC: Congelación MRV: Refrigeración Puerta de Vidrio V: Cristal D: Grupo a Distancia (no incluido) TC: Todo Cajones

MESAS FRÍO SNACK MR / MC / FR

FRV20003



MR20003



		MR15002	MR20003	MR25004	MC15002	MC20003	FR15002	FR20003	FR25004
Dim. sin Emb. (L x P x A)	mm	1492 x 600 x 850	2017 x 600 x 850	2542 x 600 x 850	1492 x 600 x 850	2017 x 600 x 850	1492 x 600 x 1045	2017 x 600 x 1045	2542 x 600 x 1045
Dim. Emb. (L x P x A)	mm	1600 x 680 x 1060	2150 x 680 x 1060	2660 x 680 x 1060	1600 x 680 x 1060	2150 x 680 x 1060	1600 x 680 x 1255	2150 x 680 x 1255	2660 x 680 x 1255
P.V.P.	€	2.049 €	2.340 €	2.735 €	2.595 €	2.716 €	2.267 €	2.664 €	3.136 €

		MRV15002	MRV20003	MRV25004
Dim. sin Emb. (L x P x A)	mm	1492 x 600 x 850	2017 x 600 x 850	2542 x 600 x 850
Dim. Emb. (L x P x A)	mm	1600 x 680 x 1060	2150 x 680 x 1060	2660 x 680 x 1060
P.V.P.	€	2.356 €	2.716 €	3.175 €

		FRV15002	FRV20003	FRV25004
Dim. sin Emb. (L x P x A)	mm	1492 x 600 x 1045	2017 x 600 x 1045	2542 x 600 x 1045
Dim. Emb. (L x P x A)	mm	1600 x 680 x 1255	2150 x 680 x 1255	2660 x 680 x 1255
P.V.P.	€	2.582 €	3.040 €	3.563 €

		MR15002 D	MR20003 D	MR25004 D
Dim. sin Emb. (L x P x A)	mm	1192 x 600 x 850	1717 x 600 x 850	2242 x 600 x 850
Dim. Emb. (L x P x A)	mm	1600 x 680 x 1060	2150 x 680 x 1060	2660 x 680 x 1060
P.V.P.	€	1.750 €	2.155 €	2.574 €

		FR15002 D	FR20003 D	FR25004 D
Dim. sin Emb. (L x P x A)	mm	1192 x 600 x 1045	1717 x 600 x 1045	2242 x 600 x 1045
Dim. Emb. (L x P x A)	mm	1600 x 680 x 1255	2150 x 680 x 1255	2660 x 680 x 1255
P.V.P.	€	2.111 €	2.476 €	2.928 €

		MR15002 TC	MR20003 TC	MR25004 TC
Dim. sin Emb. (L x P x A)	mm	1492 x 600 x 850	2017 x 600 x 850	2542 x 600 x 850
Dim. Emb. (L x P x A)	mm	1600 x 680 x 1060	2150 x 680 x 1060	2660 x 680 x 1060
P.V.P.	€	3.607 €	4.453 €	5.860 €

MESAS FRÍO PROFESIONAL

COREQUIP

Características generales:

- Control electrónico y digital de la temperatura de desescarche.
- Evaporación automática del agua de desescarche.
- Estantes GN1/1 (530x325mm) en varilla de acero plastificado con guías de altura regulable.: 1 parrilla y 2 juego de guías por puerta.
- Patas de acero inoxidable regulables en altura.
- Trasera en galvanizado.
- Los Equipos de Grupo a Distancia, no llevan incluido el grupo frigorífico independiente (solicitar cotización para 5m).

- Interior y exterior en acero inoxidable AISI 304.
- Peto sanitario de 100mm
- Dispositivo automático de cierre.
- Refrigerante R290a en refrigeración y congelación.
- Refrigeración por tiro forzado.
- Tensión de trabajo 230 V-1N-50 Hz.
- Modelos con puerta de cristal:
 - Resistencia en las puertas.
 - Iluminación LED interior.

OPCIONAL

- Mueble tropicalizado.
- Ruedas.
- Fregadero.
- Compresor a la izquierda.
- Kit Cajones.
- Sin encimera o con granito.
- Sin peto.
- Grupo a Distancia.



	Puertas	Rango de temperatura	Vol. neto / cap. útil	Potencia frigorífica	Potencia eléctrica	Consumo energético	Clasif. energética	Peso neto / bruto
	Uds.	°C	L.	W.	W.	Kwh/24h.		Kg.
REFRIGERACIÓN (Temperatura ambiente de 38°C)								
MRGN14002	2	- 2°C /+ 8°C	290	250	220	2,79	C	112
MRGN18003	3	- 2°C /+ 8°C	452	250	220	3,06	C	139
MRGN23004	4	- 2°C /+ 8°C	617	561	349	5,26	E	166
MRVGN14002	2 Cristal	- 2°C /+ 8°C	290	250	220	-	-	112
MRVGN18003	3 Cristal	- 2°C /+ 8°C	452	250	220	-	-	139
MRVGN23004	4 Cristal	- 2°C /+ 8°C	617	561	349	-	-	166
MRGN14002 TC	2/4	- 2°C /+ 8°C	290	250	220	2,79	C	136
MRGN18003 TC	3/6	- 2°C /+ 8°C	452	250	220	3,06	D	151
MRGN23004 TC	4/8	- 2°C /+ 8°C	617	561	349	5,26	E	214
MRBGN14002	2	- 2°C /+ 8°C	290	250	220	3,27	D	107
MRBGN18003	3	- 2°C /+ 8°C	452	250	220	3,27	D	146
MRBGN23004	4	- 2°C /+ 8°C	617	561	349	5,26	E	185
CONGELACIÓN (Temperatura ambiente de 38°C)								
MCGN14002	2	- 15°C /- 22°C	290	364	667	6,06	D	112
MCGN18003	3	- 15°C /- 22°C	452	364	676	6,76	D	139

MR: Refrigeración

MC: Congelación

MRV: Refrigeración Puerta de Vidrio

MRB: Mesa Baja (560mm de altura)

TC: Todo Cajones

MESAS FRÍO GASTRONORM

MRGN14002



MRGN14002

MRGN18003

MRGN23004

MCGN14002

MCGN18003

Dim. sin Embalar (L x P x A)	mm	1342 x 700 x 850	1792 x 700 x 850	2242 x 700 x 850	1342 x 700 x 850	1792 x 700 x 850
Dim. Embalada (L x P x A)	mm	1455 x 825 x 1060	1910 x 825 x 1060	2353 x 825 x 1060	1455 x 825 x 1060	1910 x 825 x 1060
P.V.P.	€	2.598 €	2.950 €	3.379 €	3.098 €	3.642 €

MRVGN14002

MRVGN18003

MRVGN23004

Dim. sin Embalar (L x P x A)	mm	1342 x 700 x 850	1792 x 700 x 850	2242 x 700 x 850
Dim. Embalada (L x P x A)	mm	1455 x 825 x 1060	1910 x 825 x 1060	2353 x 825 x 1060
P.V.P.	€	3.063 €	3.582 €	4.556 €

MRGN14002 TC

MRGN18003 TC

MRGN23004 TC

Dim. sin Embalar (L x P x A)	mm	1342 x 700 x 850	1792 x 700 x 850	2242 x 700 x 850
Dim. Embalada (L x P x A)	mm	1455 x 825 x 1060	1910 x 825 x 1060	2353 x 825 x 1060
P.V.P.	€	4.131 €	5.397 €	6.327 €

MRBGN14002

MRBGN18003

MRBGN23004

Dim. sin Embalar (L x P x A)	mm	1342 x 700 x 560	1792 x 700 x 560	2242 x 700 x 560
Dim. Embalada (L x P x A)	mm	1455 x 825 x 770	1910 x 825 x 770	2353 x 825 x 770
P.V.P.	€	2.918 €	3.402 €	4.333 €

5 MESAS REFRIGERADAS

REFRIGERATED COUNTER

MEUBLE RÉFRIGÉRÉE



CARACTERÍSTICAS TÉCNICAS

- Exterior en acero inox AISI-304 18/10, excepto el respaldo
- Interior en acero inox AISI-304 18/10, con aristas curvas y fondo embutido
- Puertas de apertura reversible, con sistema de cierre automático y burlete magnético (permanece abierta al superar los 90° de apertura)
- Contrapuerta inox embutida
- Luz interior en modelos puerta de cristal
- Encimera de acero inox AISI-304 18/10 con frente curvo y peto trasero sanitario de 100 mm (opcional sin peto según modelo)
- Estantes interiores de varilla en acero plastificado, regulables en altura, sobre apoyos inox
- Pies en tubo de acero inox ajustables en altura 125 200 mm
- Unidad condensadora ventilada y extraíble
- Evaporador sistema tiro forzado, con recubrimiento anticorrosión
- Evaporación automática del agua de descarga de serie, excepto modelos pre-instalación
- Aislamiento de poliuretano inyectado, densidad 40 Kg/m³, bajo GWP y cero efecto ODP
- Control digital de temperatura y descargas, eficiente en la gestión del consumo de energía
- Temperatura de trabajo a 32°C ambiente
- Cajoneras inox refrigeradas desmontables sobre guías telescópicas con sistema autocierre

TECHNICAL DATA

- AISI-304 18/10 stainless steel exterior, except the rear side
- AISI-304 18/10 stainless steel interior, stamped bottom and rounded corners
- Doors with self closing system, blocked opening, magnetic gasket and possibility of changing the opening sense
- Rear-door by stamped steel
- Interior light in glass door models
- AISI-304 18/10 stainless steel worktop, with round front and 100 mm sanitary up stand (optional without up stand depending on model)
- Shelves made of plasticized steel wire, height adjustable by stainless steel supports
- AISI -304 18/10 adjustable legs, 125 to 200 mm
- Removable and fan assisted condenser unit
- Fan assisted evaporator, with anticorrosion coating.
- Automatic evaporation of defrost water ass standard, except models preinstaltion
- 40 Kg/m³ density polyurethane insulation, low GWP and zero ODP effect
- Energy efficient digital controller of temperature and defrosts
- Operating temperature 32°C ambient
- Removable stainless refrigerated drawers on telescopic guides with self-closing system

CARACTÉRISTIQUES TECHNIQUES

- Extérieur en acier inox AISI 304 18/10, à l'exception de la partie arrière
- Intérieur en acier inox AISI 304 18/10, avec bords incurvés et bac encastré.
- Ouverture des portes réversibles avec système de fermeture automatique avec joint magnétique (la porte se maintient ouverte lorsque l'angle dépasse les 90° à l'ouverture)
- Contreporte en Inox encastrée
- Lumière intérieure dans les modèles de portes en verre
- Plan de travail en acier inoxydable AISI 304 18/10 avec avant incurvé et arrière avec bavette de 100mm et évacuation sanitaire (sur option : sans bavette en fonction du modèle)
- Étagères intérieures avec Fils d'acier plastifiés, réglables en hauteur, posées sur soutien en inox.
- Pies en tube d'acier inoxydable réglables en hauteur 125 - 200 mm
- Unité de condensation ventilée extractible
- Evaporateurs avec système de marche forcée et recouvrement anticorrosion.
- Evaporation automatique des eaux de dégivrage en série, sauf les modèles préinstallation.
- Isolation à base de polyuréthane injecté, densité 40 kg/m³, faible GWP et aucun effet ODP.
- Le Contrôle digital de température ainsi que le dégivrage automatique œuvre à une meilleure gestion de la consommation énergétique.
- Température ambiante de travail à 32°C
- Amovibles tiroirs réfrigérés inoxydables sur glissières télescopiques avec système de fermeture automatique



BMR Página 179
Mesas frías SNACK preinstalación
Counter SNACK preinstallation
Meuble SNACK préinstallation



BPR Página 197
Mesa pastelera
Cake counter
Meuble pâtisserie



CMR Página 183
Frente mostrador SNACK
SNACK front desk
Réception SNACK



MP / MS Página 199
Mesa fría saladette GN 1/1
GN 1/1 Saladette counter
Meuble saladette GN 1/1



CMC Página 185
Frente mostrador cafetero compacto
Front desk compact coffee
Bureau café compact avant



DMFG Página 201
Mesa fría salad-cheff GN 1/1
GN 1/1 salad-cheff counter
Meuble salad-cheff GN 1/1



CMC Página 185
Frente mostrador cafetero
Front desk coffee
Bureau café avant



DMFK Página 203
Mesa fría GN 1/1 fast food
GN 1/1 fast food counter
Meuble fast food GN 1/1



ECM Página 187
Estantería frente mostrador
Shelf front desk
Avant de conservation bureau



MEI Página 207
Mesa fría sushi-cheff
Sushi-cheff counter
Meuble sushi-cheff



DHMRG Página 189
Mesa fría GN 1/1 alta eficiencia
GN 1/1 counter high efficiency
Meuble GN 1/1 haute efficacité



DMFPP Página 207
Mesa fría pizza compacta
Compact pizza counter
Meuble compacte



BRG Página 191
Mesa fría GN 1/1
GN 1/1 counter
Meuble GN 1/1



MPC Página 213
Mesa fría pizza
Pizza counter
Meuble pizza



BCR Página 195
Mesa fría GN 1/1 bajo cocina
GN 1/1 under kitchen counter
Sous cuisine meuble GN 1/1



IE Página 215
Expositor de ingredientes
Exhibitor ingredients
Ingrédients d'exposants

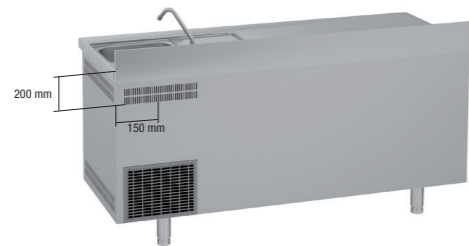
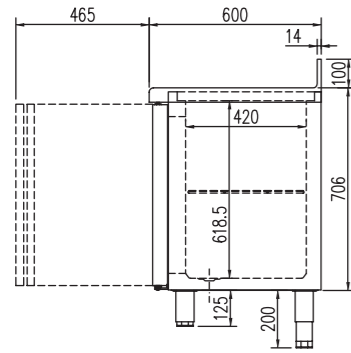

TOMA DE DESAGÜE · DRAIN OUTLET · DRAIN FAIRE



DETALLE FREGADERO · DETAIL SINK · DETAIL ÉVIER



BMR-200-2/3

Cajonera triple lado motor, es necesario instalar evaporadores centrales
 Triple sided motor chest, it is necessary to install central evaporators
 Coffre moteur à trois côtés, il est nécessaire d'installer des évaporateurs centraux

Ver características técnicas en página 176 / See technical data in page 176 / Voir caractéristiques techniques page 176

Modelo Modèle	Largo Longueur mm	Alto Hauteur mm	Fondo Profondeur mm	Rango Range Gamme	Estantes Shelves Étagères	Capacidad Capacity Exposition L	Voltaje Voltage Tension	Refrig. Coolant Frigorigène	Potencia Frig. Frig Power Puissance Frig. W	Consumo Nominal Nominal Consumption Consommation Nominale W	Rango Range Gamme	clase climate 2015/1094 EN16825
BMR-150	1495	850	600	-2°C +8°C	2	245	230 V - 50 Hz	R-290	502	235	B	5 (40°C 40%)
BMRV-150	1495	850	600	-2°C +8°C	2	245	230 V - 50 Hz	R-290	502	243	-	5 (40°C 40%)
BMR-200	2020	850	600	-2°C +8°C	3	380	230 V - 50 Hz	R-290	502	238	B	5 (40°C 40%)
BMRV-200	2020	850	600	-2°C +8°C	3	380	230 V - 50 Hz	R-290	502	251	-	5 (40°C 40%)
BMR-250	2545	850	600	-2°C +8°C	4	516	230 V - 50 Hz	R-290	845	355	C	5 (40°C 40%)
BMRV-250	2545	850	600	-2°C +8°C	4	516	230 V - 50 Hz	R-290	845	357	-	5 (40°C 40%)
BMR-300	3070	850	600	-2°C +8°C	5	651	230 V - 50 Hz	R-290	845	355	C	5 (40°C 40%)
BMRV-300	3070	850	600	-2°C +8°C	5	651	230 V - 50 Hz	R-290	845	380	-	5 (40°C 40%)
BMC-150	1495	850	600	-20°C -15°C	2	245	230 V - 50 Hz	R-290	606	535	D	5 (40°C 40%)
BMCV-150	1495	850	600	-20°C -15°C	2	245	230 V - 50 Hz	R-290	606	544	-	4 (30°C 55%)
BMC-200	2020	850	600	-20°C -15°C	3	380	230 V - 50 Hz	R-290	606	556	E	4 (30°C 55%)
BMCV-200	2020	850	600	-20°C -15°C	3	380	230 V - 50 Hz	R-290	606	548	-	4 (30°C 55%)

OPCIONES · OPTIONS · OPTIONS

Parrilla adicional 405x525 central	405x525 central extra shelf	Grille additionnelle 405x525 central	23 €
Parrilla adicional 405x460 lateral	405x460 side extra shelf	Grille additionnelle 405x460 latéral	23 €
Cajonera doble inox, auto-cierre	Double drawers set, self-closing	Tiroirs doubles inox, fermeture automatique	453€ x set
Cajonera triple inox, auto-cierre	Triple drawers set, self-closing	Tiroirs triple inox, fermeture automatique	676 € x set
Cerradura puerta inox	Solid door lock	Serrure à porte inox	23 € x ud
Cerradura puerta cristal	Glass door lock	Serrure à porte en verre	58 € x ud
Motor lado izquierdo	Left side engine	Moteur côté gauche	69 €
Encimera sin peto	No upstand worktop	Plan de travail sans panneau de protection	0 €
Set 4 ruedas	4 Castors set	Jeu 4 roulettes	93 € x set
Set 6 ruedas	6 Castors set	Jeu 6 roulettes	139 € x set
Evaporación automática	Automatic evaporation	Évaporation automatique	110 €
Registrador de alarmas HACCP	HACCP alarm recorder	Enregistreur d'alarme HACCP	consultar - consult - consulter
Tropicalizado 43°C	Tropicalized to 43°C	Tropicalisé 43°C	consultar - consult - consulter
Respaldo inox	Stainless steel rear side	Soutien en inox	consultar - consult - consulter
230V 60hz / 115v 60hz	230V 60hz / 115v 60hz	230V 60hz / 115v 60hz	consultar - consult - consulter

Características técnicas y constructivas sujetas a variación sin previo aviso. / We reserve the right to change specifications without prior notice. / Sujet technique et la conception de modifications sans préavis.



BMR-200



DETALLE TIRADOR
DETAIL HANDLE
DETAIL TIREUR



BMR-200-V

BMR-150 2.174 €	BMR-200 2.579 €	BMR-250 3.051 €	BMR-300 3.652 €
BMC-150 2.758 €	BMC-200 3.186 €	BMC-250 3.407 €	
BMR-150-V 2.550 €	BMR-200-V 3.083 €	BMR-250-V 3.701 €	BMR-300-V 4.411 €
BMC-150-V 3.116 €	BMC-200-V 3.733 €	BMC-250-V 4.497 €	
BMR-150-F 2.458 €	BMR-200-F 2.847 €	BMR-250-F 3.345 €	BMR-300-F 4.034 €

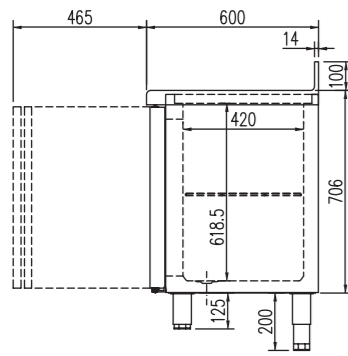

BMRP-220-2/3



DETALLE PREINSTALACION
detailed pre-installation
détailée de pré-installation

Los modelos preinstalación NO incluyen valvulería, capilar y bandeja de evaporación automática
The preinstallation models do not include valves, capillary and automatic evaporation tray
Les modèles de préinstallation ne comprennent pas les vannes, capillaire et le plateau d'évaporation automatique

MESA FRÍA SNACK REFRIGERACIÓN Y CONGELADOS PRE-INSTALACIÓN

SNACK COUNTER, CHILLER AND FREEZER FOR REMOTE CONDENSER UNIT

TABLE RÉFRIGÉRÉE SNACKS: RÉFRIGÉRATION ET CONGÉLATION: PRÉ-INSTALLATION



BMRP-220

Ver características técnicas en página 176 / See technical data in page 176 / Voir caractéristiques techniques page 176

Modelo Model Modèle	Largo Length Longueur mm	Alto Height Hauteur mm	Fondo Depth Profondeur mm	Potencia Frig. Frig Power Puissance Frig. W	Capacidad Capacity Exposition L	Peso Neto Net Weight Poid Net Kg	Estantes x set Shelves x set Étagères x set	Voltaje Voltage Tension	Refrig. Coolant Frigorigène	Rango Range Gamme
BMRP/BMRPV-120	1195	850	600	300	246	68	2	230 V - 50 Hz	R-134a	-2°C+8°C
BMRP/BMRPV-170	1720	850	600	356	380	89	3	230 V - 50 Hz	R-134a	-2°C+8°C
BMRP/BMRPV-220	2245	850	600	485	516	110	4	230 V - 50 Hz	R-134a	-2°C+8°C
BMRP/BMRPV-270	2770	850	600	485	651	135	5	230 V - 50 Hz	R-134a	-2°C+8°C
BMCP/BMCPV-120	1195	850	600	353	245	68	2	230 V - 50 Hz	R-449A	-20°C-15°C
BMCP/BMCPV-170	1720	850	600	452	380	89	3	230 V - 50 Hz	R-449A	-20°C-15°C
BMCP/BMCPV-220	2245	850	600	610	516	110	4	230 V - 50 Hz	R-449A	-20°C-15°C



BMRP-170-V

OPCIONES - OPTIONS - OPTIONS

Parrilla adicional 405x525 central	405x525 central extra shelf	Grille additionnelle 405x525 central	23 €
Parrilla adicional 405x460 lateral	405x460 side extra shelf	Grille additionnelle 405x460 latéral	23 €
Cajonera doble inox, auto-cierre	Double drawers set, self-closing	Tiroirs doubles inox, fermeture automatique	453€ x set
Cajonera triple inox, auto-cierre	Triple drawers set, self-closing	Tiroirs triple inox, fermeture automatique	676 € x set
Cerradura puerta inox	Solid door lock	Serrure à porte inox	23 € x ud
Cerradura puerta cristal	Glass door lock	Serrure à porte en verre	58 € x ud
Motor lado izquierdo	Left side engine	Moteur côté gauche	69 €
Encimera sin peto	No upstand worktop	Plan de travail sans panneau de protection	0 €
Set 4 ruedas	4 Castors set	Jeu 4 roulettes	93 € x set
Set 6 ruedas	6 Castors set	Jeu 6 roulettes	139 € x set
Evaporación automática	Automatic evaporation	Évaporation automatique	110 €
Registrador de alarmas HACCP	HACCP alarm recorder	Enregistreur d'alarme HACCP	consultar - consult - consulter
Tropicalizado 43°C	Tropicalized to 43°C	Tropicalisé 43°C	consultar - consult - consulter
Respaldo inox	Stainless steel rear side	Soutien en inox	consultar - consult - consulter
230V 60hz / 115v 60hz	230V 60hz / 115v 60hz	230V 60hz / 115v 60hz	consultar - consult - consulter

BMRP-120 1.761 € BMCP-120 1.940 €	BMRP-170 2.192 € BMCP-170 2.412 €	BMRP-220 2.539 € BMCP-220 2.777 €	BMRP-270 3.012 €
BMRP-120-V 2.057 € BMCP-120-V 2.361 €	BMRP-170-V 2.623 € BMCP-170-V 3.029 €	BMRP-220-V 3.095 € BMCP-220-V 3.582 €	BMRP-270-V 3.707 €

Características técnicas y constructivas sujetas a variación sin previo aviso. / We reserve the right to change specifications without prior notice. / Sujet technique et la conception de modifications sans préavis.

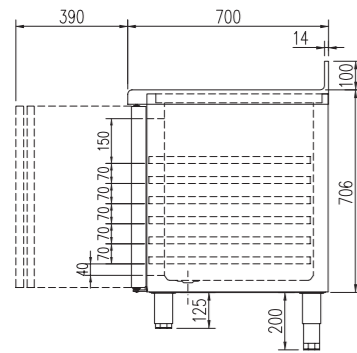

DETALLE FREGADERO - DETAIL SINK - DETAIL ÉVIER

BRG-180-2/3



BRG-180

Ver características técnicas en página 176 / See technical data in page 176 / Voir caractéristiques techniques page 176

* Gas opcional / * Optional gas / * Gaz optionnel

Modelo Model	Largo Length mm	Alto Height mm	Fondo Depth mm	Rango Range Gamme	Estantes Shelves Étagères	Pares de guías Sets of slides Kit de guides	Capacidad Capacity Exposition L	Voltaje Voltage Tension	Refrig. Coolant Frigorigène	Potencia Frig. Frig Power Puissance Frig. W	Consumo Nominal Nominal Consumption Consommation Nominale W	Rango Range Gamme	Rango Range Gamme
BRG-135	1345	850	700	-2°C +8°C	2	2	255	230 V - 50 Hz	R-290	502	235	B	5 (40°C 40%)
BRGV-135	1345	850	700	-2°C +8°C	2	2	255	230 V - 50 Hz	R-290	502	246	-	5 (40°C 40%)
BRG-180	1795	850	700	-2°C +8°C	3	3	399	230 V - 50 Hz	R-290	502	238	B	5 (40°C 40%)
BRGV-180	1795	850	700	-2°C +8°C	3	3	399	230 V - 50 Hz	R-290	502	246	-	5 (40°C 40%)
BRG-225	2245	850	700	-2°C +8°C	4	4	543	230 V - 50 Hz	R-290	845	340	C	5 (40°C 40%)
BRGV-225	2245	850	700	-2°C +8°C	4	4	543	230 V - 50 Hz	R-290	845	352	-	5 (40°C 40%)
BRG-270	2695	850	700	-2°C +8°C	5	5	686	230 V - 50 Hz	R-290	845	355	C	5 (40°C 40%)
BRGV-270	2695	850	700	-2°C +8°C	5	5	686	230 V - 50 Hz	R-290	845	369	-	5 (40°C 40%)
BCG-135	1345	850	700	-20°C -15°C	2	2	255	230 V - 50 Hz	R-290	606	535	D	5 (40°C 40%)
BCGV-135	1345	850	700	-20°C -15°C	2	2	255	230 V - 50 Hz	R-290	606	540	-	4 (30°C 55%)
BCG-180	1795	850	700	-20°C -15°C	3	3	399	230 V - 50 Hz	R-290	606	556	D	4 (30°C 55%)
BCGV-180	1795	850	700	-20°C -15°C	3	3	399	230 V - 50 Hz	R-290	606	544	-	4 (30°C 55%)



BRG-225-V

EJEMPLO CUBETAS GN Y DOTACIÓN EXTRA
 SAMPLE TRAYS GN AND EXTRA EQUIPMENT
 EXEMPLE BACS GN ET EQUIPEMENTS COMPLÉMENTAIRES

OPCIONES · OPTIONS · OPTIONS

Parrilla suplemento	Supplement extra shelf	Grille additionnelle Supplement	20 € x ud
Parrilla adicional 530 X 325 GN1/1	530 X 325 GN1/1 extra shelf	Grille additionnelle 530 X 325 GN1/1	26 € x ud
Set adicional guías GN 1/1 340500006	GN 1/1 slides extra set	Kit supplémentaire de guides GN 1/1	28 € x set
Cajonera doble inox, auto-cierre	Double drawers set, self-closing	Tiroirs doubles inox, fermeture automatique	570 € x set
Cajonera triple inox, auto-cierre	Triple drawers set, self-closing	Tiroirs triple inox, fermeture automatique	752 € x set
Cerradura puerta inox	Solid door lock	Serrure à porte inox	23 € x ud
Cerradura puerta cristal	Glass door lock	Serrure à porte en verre	58 € x ud
Motor lado izquierdo	Left side engine	Moteur côté gauche	69 €
Encimera sin peto	No upstand worktop	Plan de travail sans panneau de protection	0 €
Set 4 ruedas	4 Castors set	Jeu 4 roulettes	93 € x set
Set 6 ruedas	6 Castors set	Jeu 6 roulettes	139 € x set
Evaporación automática	Automatic evaporation	Évaporation automatique	
Registrador de alarmas HACCP	HACCP alarm recorder	Enregistreur d'alarme HACCP	consultar - consult - consulter
Tropicalizado 43°C	Tropicalized to 43°C	Tropicalisé 43°C	consultar - consult - consulter
Respaldo inox	Stainless steel rear side	Soutien en inox	consultar - consult - consulter
230V 60hz / 115v 60hz	230V 60hz / 115v 60hz	230V 60hz / 115v 60hz	consultar - consult - consulter

BRG-135 2.464 €	BRG-180 2.923 €	BRG-225 3.467 €	BRG-270 3.907 €
BCG-135 3.229 €	BCG-180 3.791 €	BCG-225 3.928 €	
BRG-135-V 2.840 €	BRG-180-V 3.430 €	BRG-225-V 4.115 €	BRG-270-V 4.742 €
BCG-135-V 3.630 €	BCG-180-V 4.386 €	BCG-225-V 5.194 €	
BRG-135-F 2.706 €	BRG-180-F 3.179 €	BRG-225-F 3.638 €	BRG-270-F 4.239 €

Características técnicas y constructivas sujetas a variación sin previo aviso. / We reserve the right to change specifications without prior notice. / Sujet technique et la conception de modifications sans préavis.

Los precios de este catálogo pueden estar desactualizados. Llámanos al 91 161 03 04 para consultar los precios en vigor.

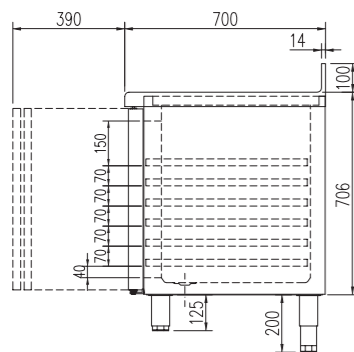

DETALLE PREINSTALACION
detailed pre-installation
détailée de pré-installation

Los modelos preinstalación NO incluyen valvulería, capilar y bandeja de evaporación automática
The preinstallation models do not include valves, capillary and automatic evaporation tray
Les modèles de préinstallation ne comprennent pas les vannes, capillaire et le plateau d'évaporation automatique

Ver características técnicas en página 176 / See technical data in page 176 / Voir caractéristiques techniques page 176

Modelo Model Modèle	Largo Length Longueur mm	Alto Height Hauteur mm	Fondo Depth Profondeur mm	Potencia Frig. Frig Power Puissance Frig. W	Capacidad Capacity Exposition L	Peso Neto Net Weight Poid Net Kg	Estantes Shelves Étagères	Pares de guías por puerta Sets of slides by door Kit de guides par porte	Voltaje Voltage Tension	Refrig. Coolant Frigorigène	Rango Range Gamme
BRGP / BRGPV-120	1045	850	700	300	255	75	2	2	230 V - 50 Hz	R-134a	-2°C+8°C
BRGP / BRGPV-170	1495	850	700	356	399	107	3	3	230 V - 50 Hz	R-134a	-2°C+8°C
BRGP / BRGPV-220	1945	850	700	485	543	139	4	4	230 V - 50 Hz	R-134a	-2°C+8°C
BRGP / BRGPV-270	2395	850	700	485	686	171	5	5	230 V - 50 Hz	R-134a	-2°C+8°C
BCGP / BCGPV-120	1045	850	700	353	255	75	2	2	230 V - 50 Hz	R-449A	-20°C-15°C
BCGP / BCGPV-170	1495	850	700	452	399	107	3	3	230 V - 50 Hz	R-449A	-20°C-15°C
BCGP / BCGPV-220	1945	850	700	610	543	139	4	4	230 V - 50 Hz	R-449A	-20°C-15°C

OPCIONES - OPTIONS - OPTIONS

Parrilla suplemento	Supplement extra shelf	Grille additionnelle Supplement	20 € x ud
Parrilla adicional 530 X 325 GN1/1	530 X 325 GN1/1 extra shelf	Grille additionnelle 530 X 325 GN1/1	26 € x ud
Set adicional guías GN 1/1 340500006	GN 1/1 slides extra set	Kit supplémentaire de guides GN 1/1	28 € x set
Cajonera doble inox, auto-cierre	Double drawers set, self-closing	Tiroirs doubles inox, fermeture automatique	570 € x set
Cajonera triple inox, auto-cierre	Triple drawers set, self-closing	Tiroirs triple inox, fermeture automatique	752 € x set
Cerradura puerta inox	Solid door lock	Serrure à porte inox	23 € x ud
Cerradura puerta cristal	Glass door lock	Serrure à porte en verre	58 € x ud
Motor lado izquierdo	Left side engine	Moteur côté gauche	69 €
Encimera sin peto	No upstand worktop	Plan de travail sans panneau de protection	0 €
Set 4 ruedas	4 Castors set	Jeu 4 roulettes	93 € x set
Set 6 ruedas	6 Castors set	Jeu 6 roulettes	139 € x set
Evaporación automática	Automatic evaporation	Évaporation automatique	110 €
Registrador de alarmas HACCP	HACCP alarm recorder	Enregistreur d'alarme HACCP	consultar - consult - consulter
Tropicalizado 43°C	Tropicalized to 43°C	Tropicalisé 43°C	consultar - consult - consulter
Respaldo inox	Stainless steel rear side	Soutien en inox	consultar - consult - consulter
230V 60hz / 115v 60hz	230V 60hz / 115v 60hz	230V 60hz / 115v 60hz	consultar - consult - consulter

MESA FRÍA GN 1/1, REFRIGERACIÓN Y CONGELADOS PRE-INSTALACION

GN 1/1 COUNTER, CHILLER AND FREEZER FOR REMOTE CONDENSER UNIT

TABLE RÉFRIGÉRÉE GN 1/1 RÉFRIGÉRATION ET CONGÉLATION: PRÉ-INSTALLATION



BRGP-220



BRGP-220-V

BRGP-120 1.876 € BCGP-120 2.036 €	BRGP-170 2.259 € BCGP-170 2.438 €	BRGP-220 2.744 € BCGP-220 2.860 €	BRGP-270 3.179 €
BRGP-120-V 2.181 € BCGP-120-V 2.450 €	BRGP-170-V 2.690 € BCGP-170-V 3.055 €	BRGP-220-V 3.301 € BCGP-220-V 3.667 €	BRGP-270-V 3.877 €

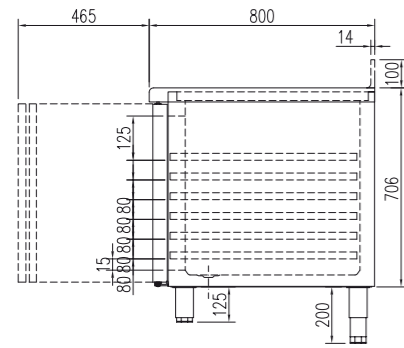

Ejemplo preinstalación
Preinstallation example
Exemple de pré-installation

OPCIONAL ENCIMERA CON PETO
OPTIONAL TOP BIB
OPTION TOP BIB



Modelos preinstalación - consultar / Pre-installation models - consult / Modèles de pré-installation - consulter



BPR-250

Ver características técnicas en página 176 / See technical data in page 176 / Voir caractéristiques techniques page 176

Modelo Modèle	Largo Longueur mm	Alto Hauteur mm	Fondo Profondeur mm	Rango Gamme	Estantes Shelves Étagères	Pares de guías Sets of slides Kit de guides	Capacidad Capacity Exposition L	Voltaje Voltage Tension	Refrig. Coolant Frigorigène	Potencia Frig. Frig Power Puissance Frig. W	Consumo Nominal Nominal Consumption Consommation Nominale W	Rango Range Gamme	clase climate 2015/1094 EN16825 Rango Range Gamme
BPR-150	1495	850	800	-2°C +8°C	0	10	362	230 V - 50 Hz	R-290	502	235	A	5 (40°C 40%)
BPRV-150	1495	850	800	-2°C +8°C	0	10	362	230 V - 50 Hz	R-290	502	244	-	4 (30°C 55%)
BPR-200	2020	850	800	-2°C +8°C	0	15	562	230 V - 50 Hz	R-290	502	238	A	5 (40°C 40%)
BPRV-200	2020	850	800	-2°C +8°C	0	15	562	230 V - 50 Hz	R-290	502	251	-	4 (30°C 55%)
BPR-250	2545	850	800	-2°C +8°C	0	20	761	230 V - 50 Hz	R-290	845	370	B	5 (40°C 40%)
BPRV-250	2545	850	800	-2°C +8°C	0	20	761	230 V - 50 Hz	R-290	845	358	-	4 (30°C 55%)
BPC-150	1495	850	800	-20°C -15°C	0	10	362	230 V - 50 Hz	R-290	606	535	E	5 (40°C 40%)
BPCV-150	1495	850	800	-20°C -15°C	0	10	362	230 V - 50 Hz	R-290	606	544	-	4 (30°C 55%)
BPC-200	2020	850	800	-20°C -15°C	0	15	562	230 V - 50 Hz	R-290	606	556	E	4 (30°C 55%)
BPCV-200	2020	850	800	-20°C -15°C	0	15	562	230 V - 50 Hz	R-290	606	569	-	4 (30°C 55%)



BPR-250-V
EJEMPLO DOTACIÓN EXTRA
SAMPLE EXTRA EQUIPMENT
EXEMPLE EQUIPEMENTS COMPLEMENTAIRES



EJEMPLO GUÍAS PASTERAS
EXAMPLE PASTRY GUIDES
EXEMPLE DE GUIDES DE PÂTISSERIE

OPCIONES - OPTIONS - OPTIONS

Parrilla suplemento	Supplement extra shelf	Grille additionnelle Supplement	26 € x ud
Parrilla 600 x 400	600 x 400 shelf	Grille 600 x 400	26 € x ud
Set adicional guías 600 x 400 340500004	600 X 400 slides extra set	Kit supplémentaire de guides 600 x 400	22 € x set
Cerradura puerta inox	Solid door lock	Serrure à porte inox	23 € x ud
Cerradura puerta cristal	Glass door lock	Serrure à porte en verre	58€ x ud
Motor lado izquierdo	Left side engine	Moteur côté gauche	69€
Encimera con peto	Worktop with upstand	Plan de travail sans panneau de protection	0 €
Cambio R-290 por R-134a	Change R-290 for R-134a	Changer le R-290 pour le R-134a	0 €
Cambio R-290 por R-452A	Change R-290 for R-452A	Changer le R-290 pour le R-452A	0 €
Set 4 ruedas	4 Castors set	Jeu 4 roulettes	93 € x set
Set 6 ruedas	6 Castors set	Jeu 6 roulettes	139 € x set
Evaporación automática	Automatic evaporation	Évaporation automatique	110 €
Cajonera doble inox, auto-cierre	Double drawers set, self-closing	Tiroirs doubles inox, fermeture automatique	706 €
Exterior blanco o negro	Black or white exterior	Extérieur noir ou blanc	consultar - consult-consulter
Registrador de alarmas haccp	Haccp alarm recorder	Enregistreur d'alarme HACCP	consultar - consult-consulter
Tropicalizado 43°C	Tropicalized to 43°C	Tropicalisé 43°C	consultar - consult-consulter
Respaldo inox	Stainless steel rear side	Soutien en inox	consultar - consult-consulter
Encimera de granito	Granite worktop	Plan de travail de granit	consultar - consult-consulter
230V 60hz / 115v 60hz	230V 60hz / 115v 60hz	230V 60hz / 115v 60hz	consultar - consult-consulter

BPR-150 2.744 €	BPR-200 3.281 €	BPR-250 3.958 €
BPC-150 3.403 €	BPC-200 3.984 €	BPC-250 3.766 €
BPR-150-V 3.137 €	BPR-200-V 3.853 €	BPR-250-V 4.668 €
BPC-150-V 3.814 €	BPC-200-V 4.577 €	BPC-250-V 5.096 €

Características técnicas y constructivas sujetas a variación sin previo aviso. / We reserve the right to change specifications without prior notice. / Sujet technique et la conception de modifications sans préavis.



MNS-200



Encimera con canto delantero curvo.

Tirador incorporado en la puerta.

Interior con uniones curvas.

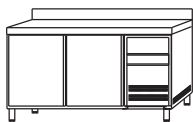

MNS-150 HC

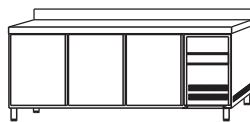

MNS-200 HC

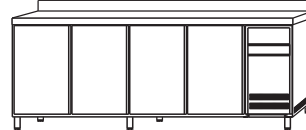

FMPS-250 HC

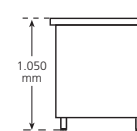

Mesas para mantenimiento de congelados Serie 600

- Encimera en acero inoxidable con acabado satinado, con canto delantero curvo y peto trasero sanitario de 100 mm.
- Estructura compacta totalmente inyectada con paneles exteriores en acero inoxidable.
- Cuerpo interior en acero inoxidable.
- Interior con uniones curvas para facilitar la limpieza.
- Puertas con tirador incorporado en acero inoxidable.
- Puertas dotadas de bisagras con sistema de retorno automático y fijación de apertura.
- Estantes interiores de varillas plastificadas, fácilmente desmontables para su limpieza.
- Soportes de sujeción de estantes regulables en altura.
- Los marcos de las puertas incorporan sistema de calefacción para evitar la acumulación de hielo.
- Pies de acero inoxidable regulables en altura.
- Contrapuertas embutidas en acero inoxidable para conseguir un mayor aislamiento y robustez.
- Desagüe en el interior de la cámara.
- Cuadro de mandos y rejilla de ventilación del motor con apertura frontal pivotante.
- Unidad condensadora hermética con condensador ventilado.
- Refrigerante ecológico R-290 libre de CFC.
- Evaporación automática del agua del desescarche.
- Aislamiento de poliuretano inyectado, libre de CFC, con una densidad de 40 Kg/m³.
- Evaporador de tiro forzado con recubrimiento anticorrosión.
- Control electrónico de la temperatura con visor digital. Desescarche automático.
- Interruptor luminoso de marcha-paro.
- Temperatura de trabajo: de -18° a -20° C con 38 °C de temperatura ambiente.
- Dotación de estantes: 1 parrilla por puerta.
- Tensión de trabajo: 230 V 1+N - 50 Hz.
- **Bajo pedido pueden fabricarse sin encimera, con el grupo frigorífico a izquierdas o a distancia.**

Mesas para mantenimiento de congelados Serie 600 de -18° a -20° C

Modelo	Referencia	N° Puertas	Clase de eficiencia energética	Consumo Energía anual (kWh/año)	Volumen (l)	Potencia (kW)	Dimensiones (mm)	P.V.P. Euros €
MNS-150 HC	19059839	2	D	2.212	250	0,67	1492 x 600 x 850	2.837,00
MNS-200 HC	19059840	3	D	2.467	390	0,68	2017 x 600 x 850	3.269,00



Encimera con canto delantero curvo.

Tirador incorporado en la puerta.

Interior con uniones curvas.

MPS-169-R

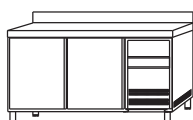

MPS-117-R
MNS-117-R
FMPS-117-R

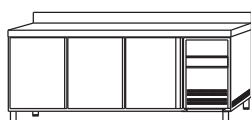

MPS-169-R
MNS-169-R
FMPS-169-R

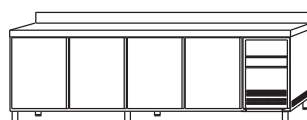

MPS-222-R
FMPS-222-R

Mesas para refrigeración, mantenimiento de congelados y frente mostrador pre-instaladas Serie 600

- Encimera en acero inoxidable con acabado satinado, con canto delantero curvo y peto trasero sanitario de 100 mm.
- Estructura compacta totalmente inyectada con paneles exteriores en acero inoxidable.
- Cuerpo interior en acero inoxidable.
- Interior con uniones curvas para facilitar la limpieza.
- Puertas con tirador incorporado en acero inoxidable.
- Puertas dotadas de bisagras con sistema de retorno automático y fijación de apertura.
- Estantes interiores de varillas plastificadas, fácilmente desmontables para su limpieza.
- Soportes de sujeción de estantes regulables en altura.
- Los marcos de las puertas incorporan sistema de calefacción para evitar la acumulación de hielo.
- Pies de acero inoxidable regulables en altura.
- Contrapuertas embutidas en acero inoxidable para conseguir un mayor aislamiento y robustez.
- Desagüe en el interior de la cámara.
- Preparadas para refrigerante ecológico R-290 libre de CFC.
- Aislamiento de poliuretano inyectado, libre de CFC, con una densidad de 40 Kg/m³.
- Evaporador de tiro forzado con recubrimiento anticorrosión.
- Control electrónico de la temperatura con visor digital.
- Interruptor luminoso de marcha-paro.
- Dotación de estantes: 1 parrilla por puerta.
- Tensión de trabajo: 230 V 1+N - 50 Hz.
- Bajo pedido pueden fabricarse sin encimera, con el grupo frigorífico a izquierdas o a distancia, puertas de cristal, etc.

Mesa refrigeración snack de -2° a +8° C

Modelo	Referencia	Nº Puertas	Capacidad (l)	Dimensiones (mm)	P.V.P. Euros €
MPS-117-R HC	19059836	2	250	1192 x 600 x 850	1.820,00
MPS-169-R HC	19076122	3	390	1717 x 600 x 850	2.239,00
MPS-222-R HC	19076126	4	530	2242 x 600 x 850	2.717,00

Mesa mantenimiento congelados de -18° a -20° C

Modelo	Referencia	Nº Puertas	Capacidad (l)	Dimensiones (mm)	P.V.P. Euros €
MNS-117-R HC	19076373	2	250	1192 x 600 x 850	2.156,00
MNS-169-R HC	19078563	3	390	1717 x 600 x 850	2.484,00

Mesa refrigerada frente mostrador de -2° a +8° C

Modelo	Referencia	Nº Puertas	Capacidad (l)	Dimensiones (mm)	P.V.P. Euros €
FMPS-117-R HC	19076089	2	335	1192 x 600 x 1045	2.092,00
FMPS-169-R HC	19076094	3	520	1717 x 600 x 1045	2.607,00
FMPS-222-R HC	19076098	4	701	2242 x 600 x 1045	3.091,00



MNG-180



Contrapuerta embutida.

Evaporador compacto de tiro forzado.

Interior con uniones curvas.

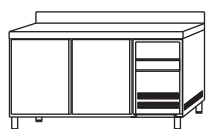

MNG-135 HC

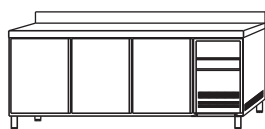

MNG-180 HC

Mesas para mantenimiento de congelados Gastronorm Serie GN 1/1

- Encimera en acero inoxidable AISI-304 18/10 acabado satinado, con canto delantero curvo y peto trasero sanitario de 100 mm.
- Estructura compacta totalmente inyectada con paneles exteriores en acero inoxidable AISI-304 18/10.
- Cuerpo interior en acero inoxidable AISI-304 18/10.
- Interior con uniones curvas para facilitar la limpieza.
- Puertas con tirador incorporado en acero inoxidable AISI-304 18/10.
- Puertas dotadas de bisagras con sistema de retorno automático y fijación de apertura en las puertas.
- Contrapuestas embutidas en acero inoxidable AISI-304 18/10, para conseguir un mayor aislamiento y robustez, con burlete de fácil sustitución en todo el contorno.
- Estantes interiores de varillas plastificadas, fácilmente desmontables para su limpieza.
- Soportes de sujeción de estantes regulables en altura.
- Los marcos de las puertas incorporan un sistema de calefacción para evitar la acumulación de hielo.
- Pies de acero inoxidable regulables en altura.
- Desagüe en el interior de la cámara.
- Cuadro de mandos y rejilla de ventilación del motor con apertura frontal pivotante.
- Unidad condensadora hermética con condensador ventilado.
- Refrigerante ecológico R-290 libre de CFC.
- Evaporador de tiro forzado con recubrimiento anticorrosión.
- Evaporación automática del agua del desescarche.
- Aislamiento de poliuretano inyectado, libre de CFC, con una densidad de 40 Kg/m³.
- Interruptor luminoso de marcha-paro.
- Control electrónico de la temperatura con visor digital. Desescarche automático.
- Temperatura de trabajo: -18° a -20° C con 38 °C de temperatura ambiente.
- Dotación: 1 parrilla GN 1/1 y dos juegos de guías por puerta.
- Tensión de trabajo: 230 V 1+N - 50 Hz.
- **Bajo pedido pueden fabricarse sin encimera, con el grupo frigorífico a izquierdas o a distancia.**

Mesas para mantenimiento de congelados Gastronorm Serie GN 1/1 de -18° C a -20° C

Modelo	Referencia	Nº puertas	Clase de eficiencia energética	Consumo Energía anual (kWh/año)	Capacidad (l)	Potencia (kW)	Dimensiones (mm)	P.V.P. Euros €
MNG-135 HC	19059925	2	D	2212	290	0.667	1342 x 700 x 850	3.267,00
MNG-180 HC	19059931	3	D	2467	455	0.676	1792 x 700 x 850	3.846,00



MPG-147



Contrapuerta embutida.

Tirador incorporado en la puerta.

Encimera con canto delantero curvo.

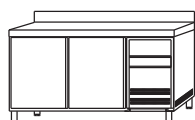

MPG-102
MNG-102

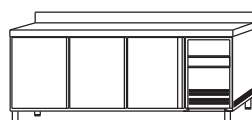

MPG-147
MNG-147

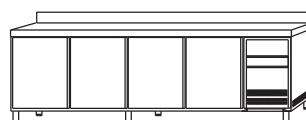

MPG-192-GN-R HC

Mesas refrigeradas Gastronorm Serie GN 1/1

- Encimera en acero inoxidable con acabado satinado, con canto delantero curvo y peto trasero sanitario de 100 mm.
- Estructura compacta totalmente inyectada con paneles exteriores en acero inoxidable.
- Cuerpo interior en acero inoxidable.
- Puertas con tirador incorporado en acero inoxidable.
- Interior con uniones curvas para facilitar la limpieza.
- Contrapuertas embutidas en acero inoxidable para conseguir un mayor aislamiento y robustez, con burlate de fácil sustitución en todo el contorno.
- Puertas dotadas de bisagras con sistema de retorno automático y fijación de apertura.
- Estantes interiores de varillas plastificadas, fácilmente desmontables para su limpieza.
- Soportes de sujeción de estantes regulables en altura.
- Pies de acero inoxidable regulables en altura.
- Desagüe en el interior de la cámara.
- Preparada para refrigerante ecológico R-290.
- Evaporador de tiro forzado con recubrimiento anticorrosión.
- Aislamiento de poliuretano inyectado, libre de CFC, con una densidad de 40 Kg/m³.
- Interruptor luminoso de marcha-paro.
- Control electrónico de la temperatura con visor digital.
- Dotación: 1 parrilla GN 1/1 y dos juegos de guías por puerta.
- Tensión de trabajo: 230 V 1+N - 50 Hz.

Mesa refrigerada Gastronorm de -2° a +8° C

Modelo	Referencia	Nº puertas	Capacidad (l)	Dimensiones (mm)	P.V.P. Euros €
MPG-102-GN-R HC	19059866	2	290	1042 x 700 x 850	1.932,00
MPG-147-GN-R HC	19068969	3	455	1492 x 700 x 850	2.374,00
MPG-192-GN-R HC	19068990	4	615	1942 x 700 x 850	2.809,00

Mesa mantenimiento congelados de -18° a -20° C

Modelo	Referencia	Nº puertas	Capacidad (l)	Dimensiones (mm)	P.V.P. Euros €
MNG-102-GN-R HC	19068449	2	290	1042 x 700 x 850	2.287,00
MNG-147-GN-R HC	19069405	3	455	1492 x 700 x 850	2.769,00

Accesorios mesas refrigeradas

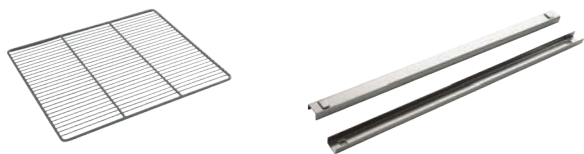

TIPO	Modelo	Referencia	Longitud (mm)	Familia	Modelos asociados	Características	P.V.P. Euros €
PARIILLAS	APMS525	19014763	525 x 405	Mesas 600	MPS, MPSF, MNS, FMPS	Parrilla central	22,00
	APMS460	19014764	460 x 405	Mesas 600	MPS, MPSF, MNS, FMPS	Parilla extremo	22,00
	EVP 1/1	19001002	325 x 530	Mesas Gastronorm	MPG, MPGF, MPGP, MPGE, MNG	Parrilla GN 1/1	15,00
SUJECCIÓN PARIILLAS	ASMS3N	19014765	-	Mesas 600	MPS, MPSF, MNS, FMPS	Soporte de 3 niveles	-
	AGMG562	19010572	562	Mesas Gastronorm	MPG, MPGF, MNG, MPGP, MPGE	Par de guías	-
PARIILLAS BOTELLEROS	APB400	19014766	400 x 500	Botellero	EB	Parrilla vertical	21,00
	APB445	19004308	Botellero	EBE	Parrilla vertical		21,00
SUJECCIÓN PARIILLAS	ASB	19014767		Botellero	EB	4 x parrilla	1,00
RUEDAS	MR4R	19016846	Mesas Snack y Gastronorm	100	Mesas Snack y Gastronorm	APS, ANS, APG y ANG	108,00

Opciones de mesas: Incremento / reducción de P.V.P según opción

Tipo de mesa	Opciones	P.V.P. Euros €
Mesa snack MPS,FMPS,MNS	Sin encimera	-163,00 €
	Sin peto	0,00 €
	Grupo Izquierda	66,00 €
	Kit 4 ruedas	108,00 €
Mesa gastronorm MPG,MNG	Cerradura	36 €
	Tolva	180 €
	Respaldo Inox	Consultar precio

Precio P.V.P de los modelos de mesa con las opciones más habituales

SERIE SNACK	REFRIGERACIÓN			CONGELACIÓN	
	19059752	19059791	19059820	19059839	19059840
	MPS-150 HC	MPS-200 HC	MPS-250 HC	MNS-150 HC	MNS-200 HC
Sin encimera	2.005,00 €	2.410,00 €	2.889,00 €	2.674,00 €	3.106,00 €
Sin peto	2.168,00 €	2.573,00 €	3.052,00 €	2.837,00 €	3.269,00 €
Grupo Izquierda	2.234,00 €	2.639,00 €	3.118,00 €	2.903,00 €	3.335,00 €
Kit 4 ruedas	2.276,00 €	2.681,00 €	3.160,00 €	2.945,00 €	3.377,00 €
Cerradura	2.240,00 €	2.681,00 €	3.196,00 €	2.909,00 €	3.377,00 €

Precio P.V.P de los modelos de mesa con las opciones más habituales

SERIE GASTRONORM	REFRIGERACIÓN			CONGELACIÓN	
	19059852	19059875	19059909	19059925	19059931
	MPG-135 HC	MPG-180 HC	MPG-225 HC	MNG-135 HC	MNG-180 HC
Sin encimera	2.283,00 €	2.732,00 €	3.262,00 €	3.104,00 €	3.683,00 €
Sin peto	2.446,00 €	2.895,00 €	3.425,00 €	3.267,00 €	3.846,00 €
Grupo Izquierda	2.512,00 €	2.961,00 €	3.491,00 €	3.333,00 €	3.912,00 €
Kit 4 ruedas	2.554,00 €	3.003,00 €	3.533,00 €	3.375,00 €	3.954,00 €
Cerradura	2.518,00 €	3.003,00 €	3.569,00 €	3.339,00 €	3.954,00 €

SR / SF

CARACTERÍSTICAS PRINCIPALES

- Modelos de 60 cm de fondo fabricados tanto interior como exteriormente en acero inoxidable.
- Puertas dotadas de autocierre.
- 2 estantes regulables de serie por cada puerta.
- Desescarche eléctrico y termostato digital de serie.
- Todos los modelos incluyen pies ajustables (de 125 a 185 mm).
- Ruedas opcionales.
- Burletes extraíbles para su fácil sustitución.
- Disponible como accesorio kit de 2 o de 3 cajones fácilmente sustituibles.
- Todos los modelos SR disponen de cajón neutro.

CARACTERÍSTICAS TÉCNICAS

MODELO	SIN PETO			CON PETO		
	SR 2100	SR 3100	SR 4100	SR 2200	SR 3200	SR 4200
Código	0YRW0074	0YRW0077	0YRW0081	0YRW0075	0YRW0078	0YRW0082
Capacidad neta	L 230	358	485	230	358	485
Rango de temperatura	°C -2 / +8	-2 / +8	-2 / +8	-2 / +8	-2 / +8	-2 / +8
Alimentación eléctrica	Vn°/Hz 230/1/50	230/1/50	230/1/50	230/1/50	230/1/50	230/1/50
Potencia eléctrica	W 362	372	372	362	372	372
Clase climática	Tipo 4	4	4	4	4	4
Clase energética	Tipo C	C	D	C	C	D
Refrigerante	Tipo R290	R290	R290	R290	R290	R290
Desescarche	Tipo Automático	Automático	Automático	Automático	Automático	Automático
Ancho / fondo / alto	mm 1350 x 600 x 850	1800 x 600 x 850	2250 x 600 x 850	1350 x 600 x 950	1800 x 600 x 950	2250 x 600 x 950
Dimensiones interiores	mm 810 x 485 x 585	1260 x 485 x 585	1710 x 485 x 585	810 x 485 x 585	1260 x 485 x 585	1710 x 485 x 585
Peso neto	kg	114	140	92	116	143
PVP	2.195 €	2.495 €	2.810 €	2.260 €	2.475 €	2.825 €

MODELO	SIN PETO			CON PETO		
	SF 2100	SF 3100	SF 4100	SF 2200	SF 3200	SF 4200
Código	0YRW0009	0YRW0011	0YRW0013	0YRW0010	0YRW0012	0YRW0014
Capacidad neta	L 230	358	485	230	358	485
Rango de temperatura	°C -22 / -18	-22 / -18	-22 / -18	-22 / -18	-22 / -18	-22 / -18
Alimentación eléctrica	Vn°/Hz 230/1/50	230/1/50	230/1/50	230/1/50	230/1/50	230/1/50
Potencia eléctrica	W 600	700	700	600	700	700
Clase climática	Tipo 4	4	4	4	4	4
Clase energética	Tipo D	D	D	D	D	D
Refrigerante	Tipo R290	R290	R290	R290	R290	R290
Desescarche	Tipo Eléctrico	Eléctrico	Eléctrico	Eléctrico	Eléctrico	Eléctrico
Ancho / fondo / alto	mm 1350 x 600 x 850	1800 x 600 x 850	2250 x 600 x 850	1350 x 600 x 950	1800 x 600 x 950	2250 x 600 x 950
Dimensiones interiores	mm 810 x 485 x 585	1260 x 485 x 585	1710 x 485 x 585	810 x 485 x 585	1260 x 485 x 585	1710 x 485 x 585
Peso neto	kg 111	137	147	113	139	151
PVP	2.590 €	2.925 €	3.085 €	2.655 €	3.100 €	3.285 €

ACCESORIOS

	Set Cajones 1/3 + 1/3 + 1/3*	Set Cajones 1/2 + 1/2*	Juego de guías	Kit de ruedas QR / QN / SR / SF / QZ	Estante adicional
Código	0YRW9028	0YRW9011	0YRW9007	0YRW9016	0YRW9005
PVP	865 €	690 €	55 €	240 €	40 €

*Solo para modelos SR.

Aplicaciones

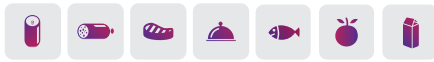

Características



SR2200



SR 4200



SR 4200



2 estantes regulables en altura en cada puerta.



Pies regulables en altura.



Kit de 2 o 3 cajones como accesorio.

SR / SF

COTAS

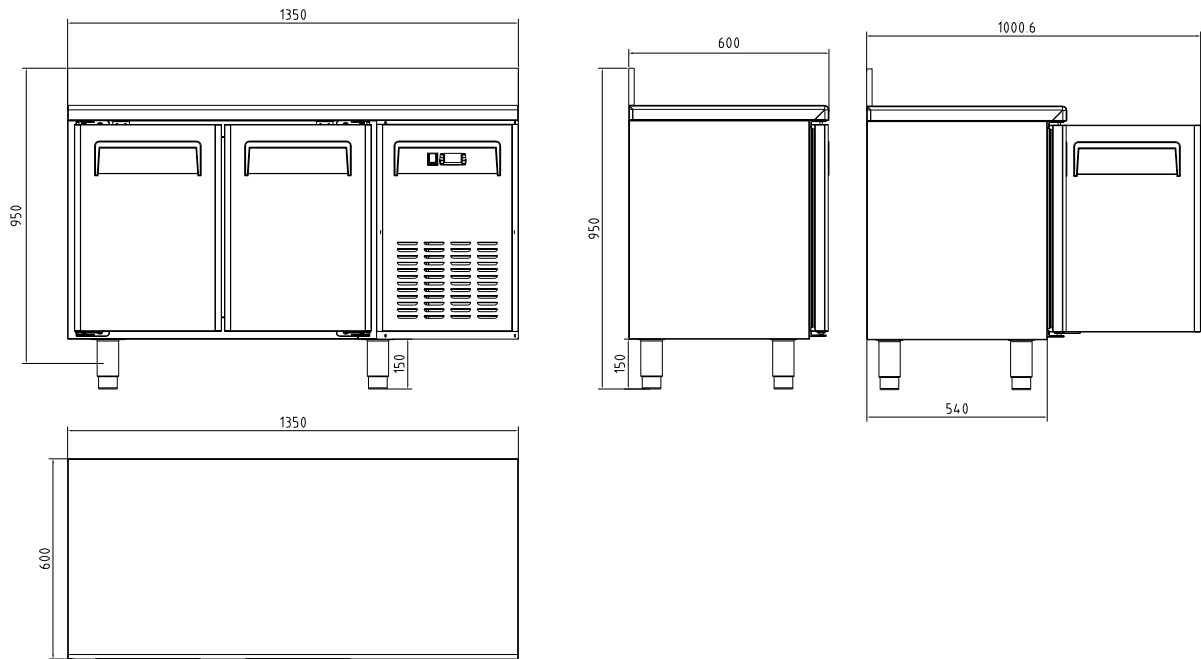

SR 2200 - SF 2200

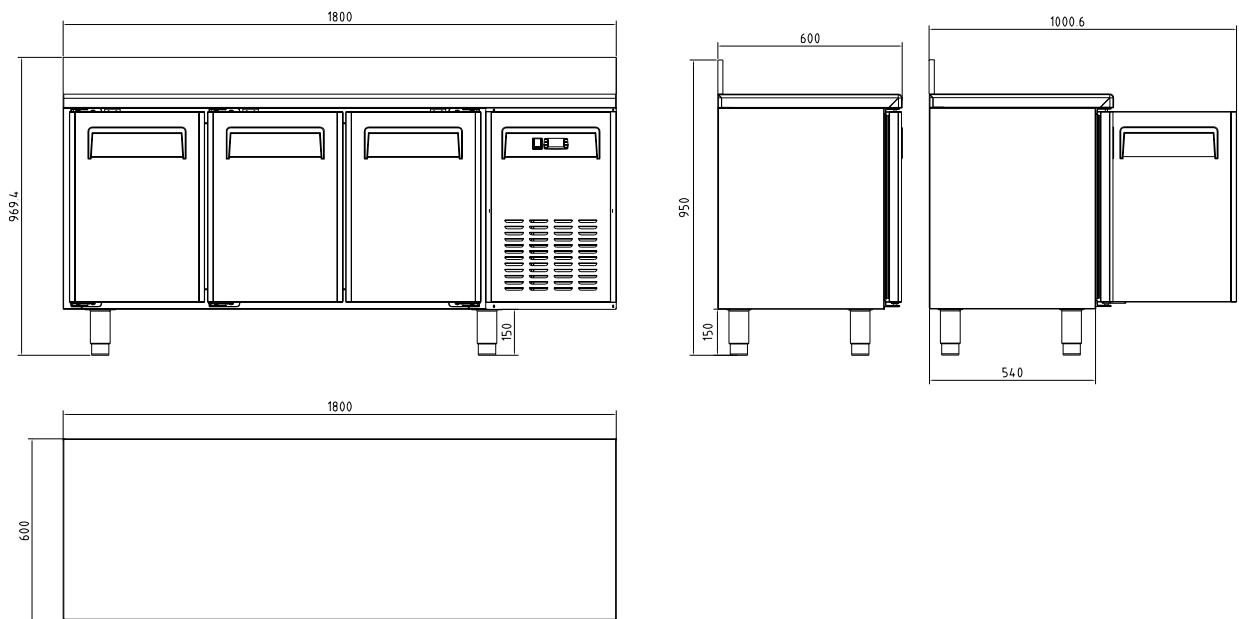

SR 3200 - SF 3200

Aplicaciones



Características

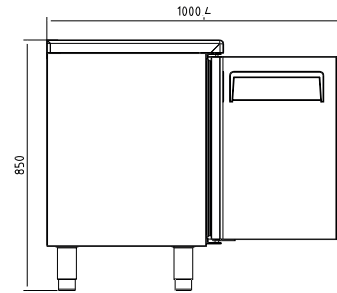
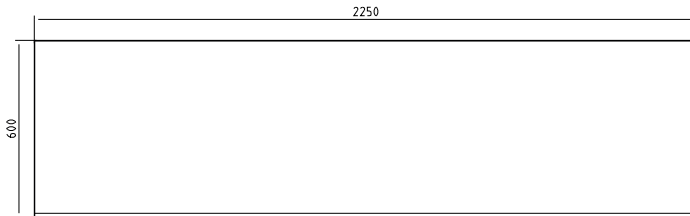
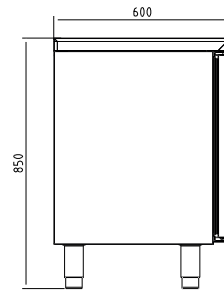
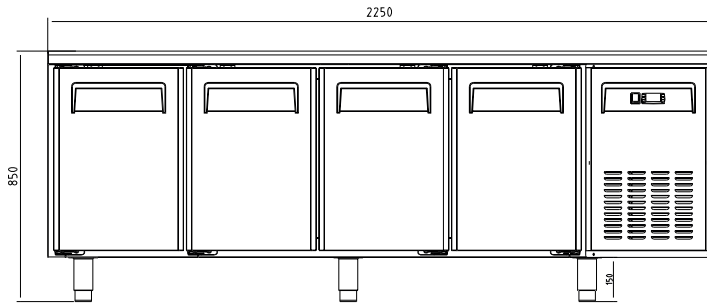

SR 4100 - SF 4100

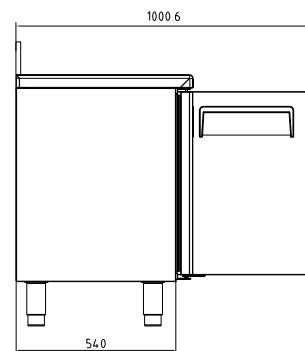
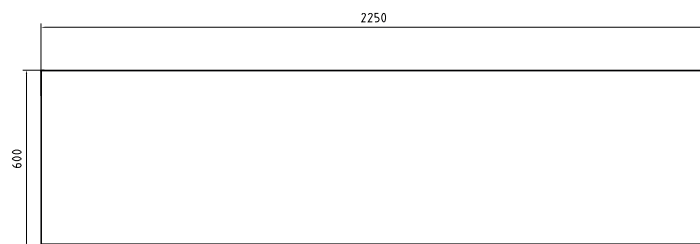
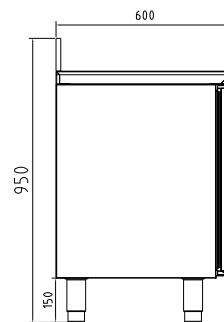
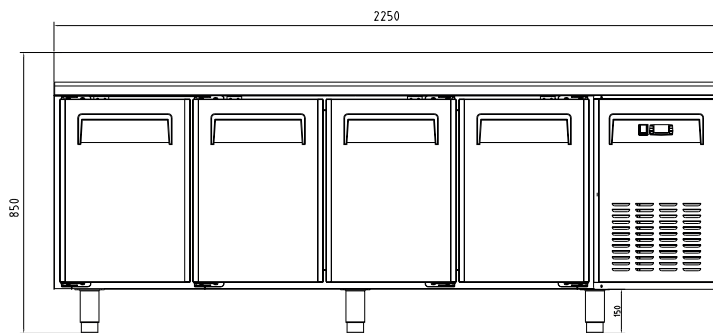

SR 4200 - SF 4200

QR / QN

CARACTERÍSTICAS PRINCIPALES

- Gama de armarios de servicio de 285 L netos, de conservación y congelación en acero inoxidable.
- Ambos modelos disponen de cerradura con llave y puerta reversible de autocierre.
- Burlete térmico de plástico anti-condensación.
- Evaporador con tratamiento anticorrosión.
- Termostato digital Dixell Blue line.
- Ambos modelos llevan gas R-290 para asegurar un alto nivel de rendimiento, con un impacto ambiental reducido.
- Dispone de dos patas ajustables en la parte frontal y dos ruedas en la parte posterior para facilitar el desplazamiento.
- Incluye 3 estantes ajustables de GN 1/1 y guías internas onduladas.

CARACTERÍSTICAS TÉCNICAS

MODELO	CONSERVACIÓN					
	SIN PETO			CON PETO		
	QR 2100	QR 3100	QR 4100	QR 2200	QR 3200	QR 4200
Código	OYRW0062	OYRW0066	OYRW0070	OYRW0063	OYRW0067	OYRW0071
Capacidad neta	L 260	400	570	260	400	570
Rango de temperatura	°C -2 / +8	-2 / +8	-2 / +8	-2 / +8	-2 / +8	-2 / +8
Alimentación eléctrica	V/nº/Hz 230/1/50	230/1/50	230/1/50	230/1/50	230/1/50	230/1/50
Potencia eléctrica	W 350	350	360	350	350	360
Clase climática	Tipo 4	4	4	4	4	4
Clase energética	Tipo C	C	D	C	C	D
Refrigerante	Tipo R290	R290	R290	R290	R290	R290
Desescarche	Tipo Automático	Automático	Automático	Automático	Automático	Automático
Ancho / fondo / alto	mm 1350 x 700 x 850	1800 x 700 x 850	2250 x 700 x 850	1350 x 700 x 950	1800 x 700 x 950	2250 x 700 x 950
Dimensiones interiores	mm 930 x 585 x 585	1380 x 585 x 585	1830 x 585 x 585	930 x 585 x 585	1380 x 585 x 585	1830 x 585 x 585
Peso neto	kg 100	124	150	102	126	153
PVP	2.195 €	2.505 €	2.835 €	2.175 €	2.545 €	2.915 €

MODELO	CONGELACIÓN					
	SIN PETO			CON PETO		
	QN 2100	QN 3100	QN 4100	QN 2200	QN 3200	QN 4200
Código	OYRW0021	OYRW0023	OYRW0025	OYRW0022	OYRW0024	OYRW0026
Capacidad neta	L 260	400	570	260	400	570
Rango de temperatura	°C -22 / -18	-22 / -18	-22 / -18	-22 / -18	-22 / -18	-22 / -18
Alimentación eléctrica	V/nº/Hz 230/1/50	230/1/50	230/1/50	230/1/50	230/1/50	230/1/50
Potencia eléctrica	W 570	670	670	570	670	670
Clase climática	Tipo 4	4	4	4	4	4
Clase energética	Tipo D	D	D	D	D	D
Refrigerante	Tipo R290	R290	R290	R290	R290	R290
Desescarche	Tipo Eléctrico	Eléctrico	Eléctrico	Eléctrico	Eléctrico	Eléctrico
Ancho / fondo / alto	mm 1350 x 700 x 850	1800 x 700 x 850	2250 x 700 x 850	1350 x 700 x 950	1800 x 700 x 950	2250 x 700 x 950
Dimensiones interiores	mm 930 x 585 x 585	1380 x 585 x 585	1830 x 585 x 585	930 x 585 x 585	1380 x 585 x 585	1830 x 585 x 585
Peso neto	kg 113	150	170	115	152	175
PVP	2.735 €	3.125 €	3.255 €	2.725 €	3.125 €	3.375 €

ACCESORIOS

	Set Cajones 1/3 + 1/3 + 1/3	Set Cajones 1/2 + 1/2	Juego de guías
Código	OYRW9025	OYRW9029	OYRW9006
PVP	865 €	715 €	60 €

Aplicaciones



Características



QR2200



QR 4200



QR 4200



Posibilidad de sustituir las puertas por cajones.



2 estantes GN 1/1 de serie por puerta.



Pies regulables en altura.

QR / QN

COTAS

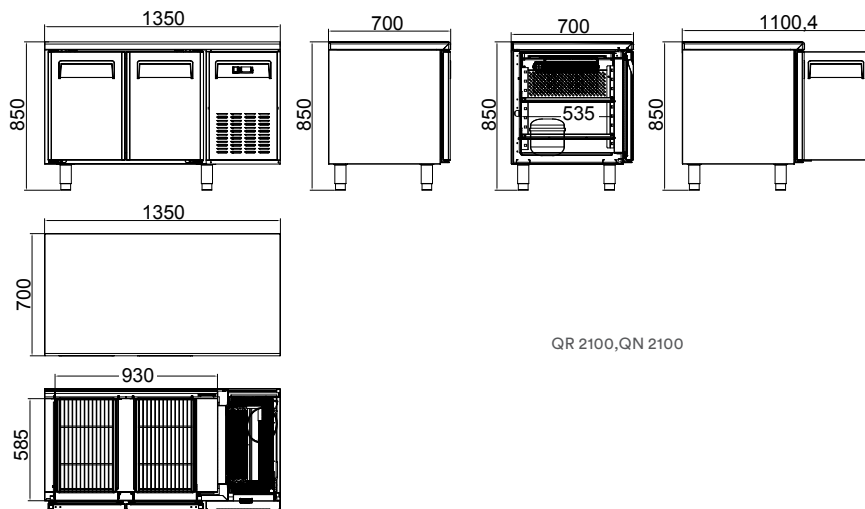

QR 2100, QN 2100

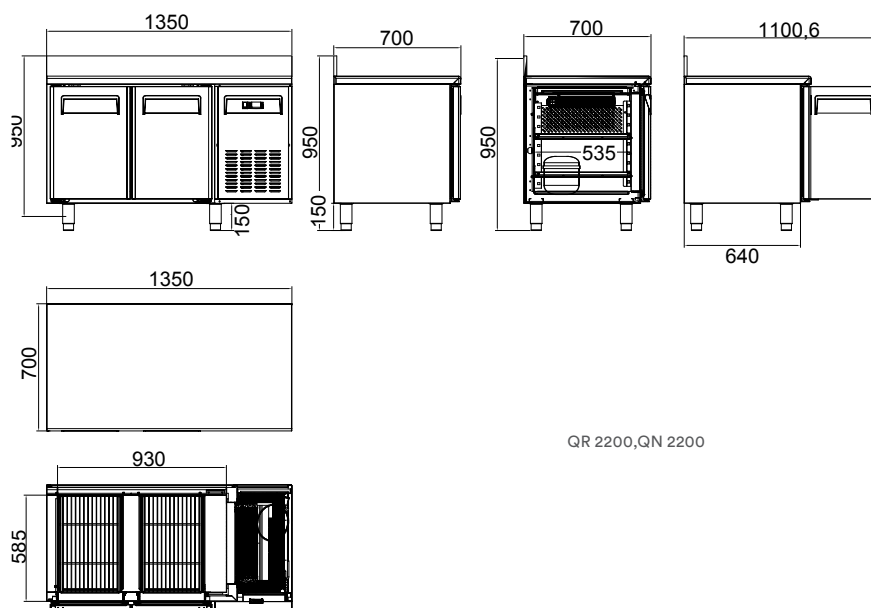

QR 2200, QN 2200

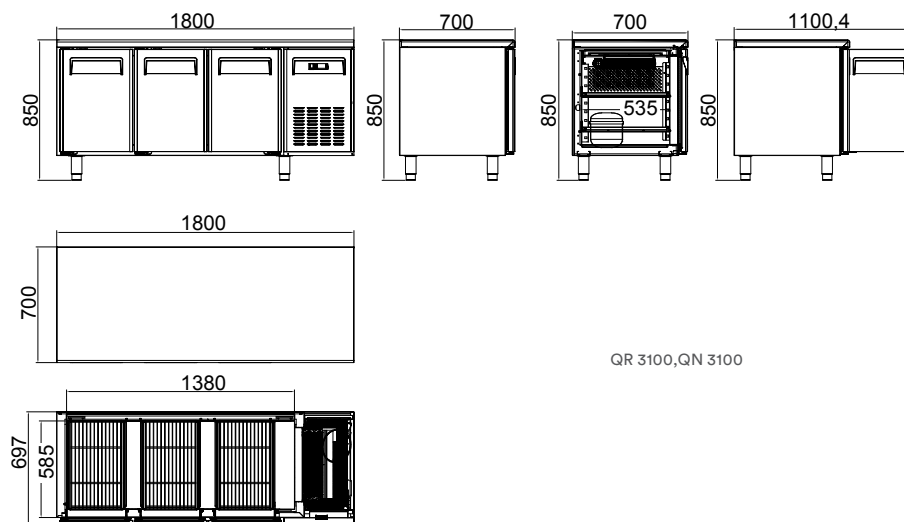

QR 3100, QN 3100

Aplicaciones



Características

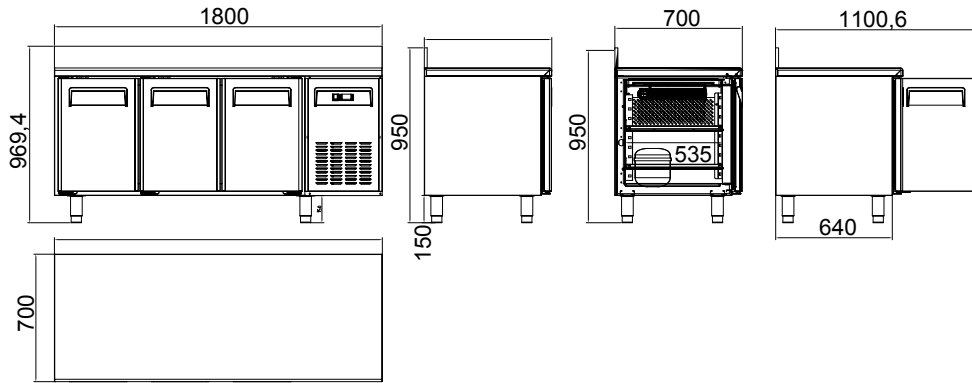

QR 4100, QN 4100

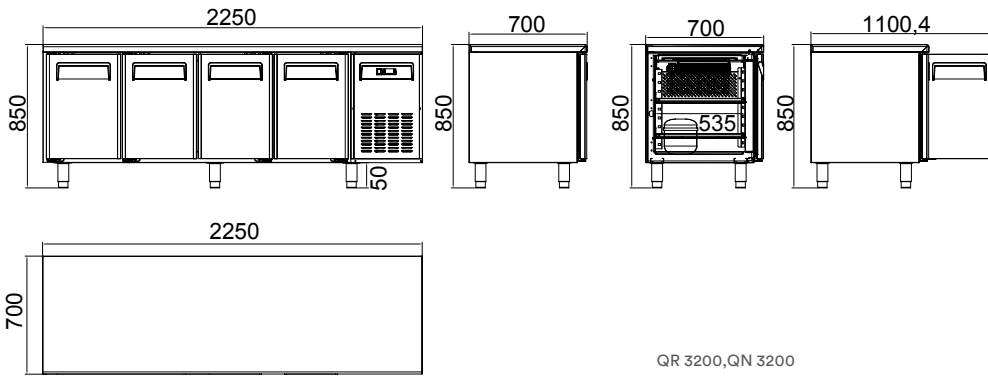
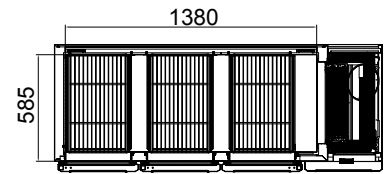

QR 3200, QN 3200

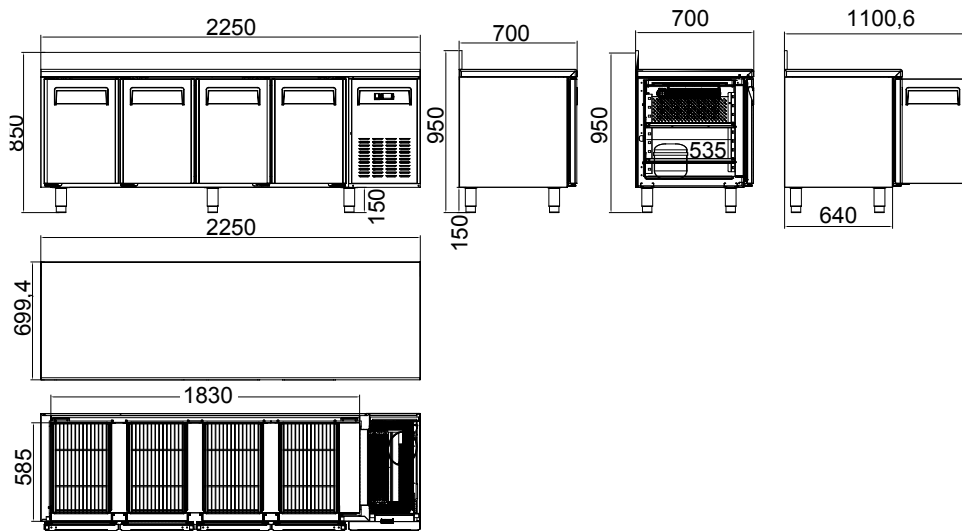
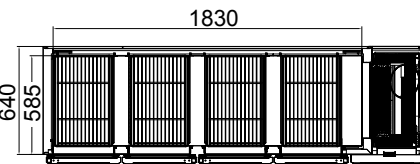
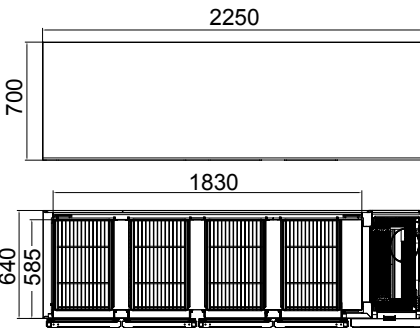

QR 4200, QN 4200

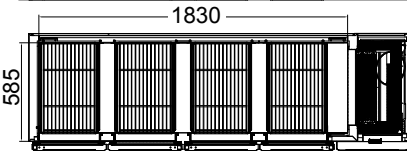
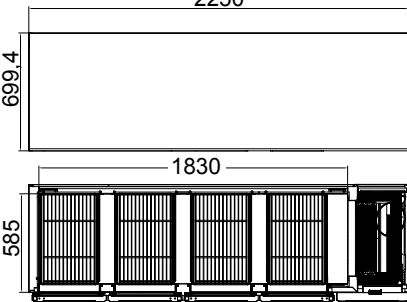

FRENTE MOSTRADOR DE LA SERIE 600 PUERTA OPACA

- Encimera en acero inoxidable con acabado satinado, con canto delantero curvo y peto trasero sanitario de 100 mm.
- Estructura compacta totalmente inyectada con paneles exteriores en acero inoxidable.
- Fabricado en Acero inoxidable AISI304 en interior y exterior del mueble. Interior con uniones curvas para facilitar la limpieza.
- Bisagras con sistema de retorno automático y fijación de apertura.
- Contrapuertas embutidas en acero inoxidable con burlete de fácil sustitución en todo el contorno.
- Estantes interiores de varillas plastificadas, fácilmente desmontables.
- Soportes de sujeción de estantes regulables en altura.
- Contrapuertas fabricadas en aluminio anticorrosivo.
- Desagüe en el interior de la cámara.
- Cuadro de mandos y rejilla de ventilación del motor con apertura frontal pivotante.
- Unidad condensadora hermética con condensador ventilado y compresores DANFOSS SECOP.
- Refrigerante ecológico R-134 A libre de CFC. Evaporador de tiro forzado con recubrimiento anticorrosión.
- 40 Kg/m³ de aislamiento de poliuretano inyectado, libre de CFC.
- Interruptor luminoso de marcha-paro. Control electrónico de la temperatura con visor digital.
- Desescarche automático con evaporación automática del agua.
- De -2° a +8° C con 38° C de temperatura ambiente.
- Todos los modelos FAP incorporan un cajón neutro auxiliar situado sobre el control electrónico de la temperatura.
- Los modelos con TOLVA sustituyen el cajón neutro por un cajón tolva.
- Dotación de estantes: 2 parrillas por puerta.
- Tensión de trabajo: 230 V 1+N – 50 Hz.

FABRICADO EN
ANDALUCÍA



Pies en acero
inoxidable



Evaporador compacto
de tiro forzado.



Contrapuerta
embutida.



Cajón incorporado disponible
para los modelos sin cajón Tolva.

FRENTE MOSTRADOR REFRIGERADO CON CAJÓN

MODELO	CÓDIGO	PUERTAS	CAPACIDAD (Litros)	POTENCIA (W)	COMPRESOR	DIMENSIONES (mm)	P.V.P.
FBR-150	19007176	2	335	350	1/5 CV	1492x600x1050	1.868
FBR-202	19007816	3	520	396	1/4 CV	2017x600x1050	2.253
FBR-255	19008024	4	701	615	3/8 CV	2542x600x1050	2.656

FRENTE MOSTRADOR REFRIGERADO CON TOLVA

MODELO	CÓDIGO	PUERTAS	CAPACIDAD (Litros)	POTENCIA (W)	COMPRESOR	DIMENSIONES (mm)	P.V.P.
FBR-150 TOLVA	19007258	2 + Tolva	335	350	1/5 CV	1492x600x1050	2.250
FBR-202 TOLVA	19007849	3 + Tolva	520	396	1/4 CV	2017x600x1050	2.650
FBR-255 TOLVA	19008073	4 + Tolva	701	615	3/8 CV	2542x600x1050	3.200

Estas maquinarias mantienen el producto en óptimas condiciones con la temperatura adecuada además, de una excelente organización.

MESAS DE LA SERIE 600 TRS / TCS

- Estructura compacta totalmente inyectada con paneles exteriores en acero inoxidable.
- Cuerpo interior en acero inoxidable.
- Puertas con tirador incorporado en acero inoxidable.
- Interior con uniones curvas para facilitar la limpieza.
- Puertas dotadas de bisagras con sistema de retorno automático y fijación de apertura.
- Los marcos de las puertas incorporan sistema de calefacción para evitar la acumulación de hielo.
- Estantes interiores de varillas plastificadas, fácilmente desmontables para su limpieza.
- Sistema de cremallera para la sujeción y regulación de los estantes.
- Pies de acero inoxidable regulables en altura.
- Contrapuertas en acero inoxidable.
- Unidad condensadora hermética con condensador ventilado.
- Refrigerante ecológico libre de CFC.
- Evaporador de tiro forzado con recubrimiento anticorrosión.
- Evaporación automática del agua del desescarche.
- Aislamiento de poliuretano inyectado, libre de CFC, con una densidad de 40 Kg/m³.
- Control electrónico de la temperatura y del desescarche con visor digital.
- Temperatura de trabajo con 38° C de temperatura ambiente.
- Dotación estantes: 3 parrillas por cuerpo.
- Tensión de trabajo: 230 V 1+N 50 Hz.

FABRICADO EN
ANDALUCÍA

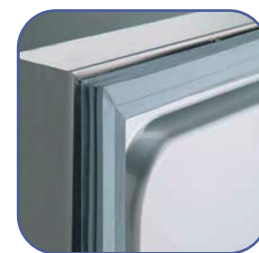

Contrapuerta embutida

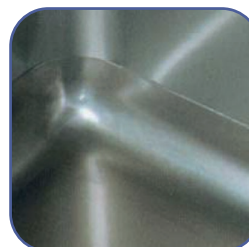

Garantía de limpieza Interior con uniones curvas



Encimera con canto delantero curvo.



Pies en acero inoxidable

TRS/TCS-200

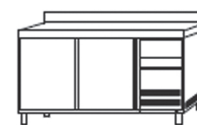

TRS/TCS-150

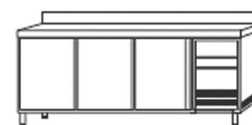

TRS/TCS-200

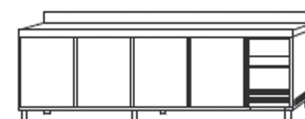

TRS/TCS-250

REFRIGERACIÓN

MODELO	REFERENCIA	PUERTAS	CAPACIDAD (Litros)	RANGO DE TEMP.	REFRIG. ECO.	POTENCIA (W)	COMPRESOR (CV)	DIMENSIONES (mm.)	P.V.P.
TRS-150	19006754	2	250	-2 a +8	R-600a	350	1/5	1492x600x850	1.699
TRS-200	19007334	3	390	-2 a +8	R-600a	396	1/4	2017x600x850	2.025
TRS-250	19007937	4	530	-2 a +8	R-600a	615	3/8	2542x600x850	2.498

MANTENIMIENTO DE CONGELADOS

MODELO	REFERENCIA	PUERTAS	CAPACIDAD (Litros)	RANGO DE TEMP.	REFRIG. ECO.	POTENCIA (W)	COMPRESOR (CV)	DIMENSIONES (mm.)	P.V.P.
TCS-150	19007002	2	250	-18° a -20°C	R-290a	350	1/5	1492x600x850	2.192
TCS-200	19007596	3	390	-18° a -20°C	R-290a	396	1/4	2017x600x850	2.400
TCS-250	19042978	4	530	-18° a -20°C	R-290a	615	3/8	2542x600x850	3.150

Estas maquinarias mantienen el producto en óptimas condiciones con la temperatura adecuada además, de una excelente organización.



Eficiencia y calidad
adaptadas a las
necesidades del
profesional.



¡Descubre!



Acceso a la web

Con nuestro amplio catálogo de mesas ofrecemos respuesta a cualquier tipo de necesidades.

La gama Advance representa la decida apuesta de Fagor por la innovación y el alineamiento con los más exigentes niveles de eficiencia energética, obteniendo la Clase A en todas las mesas de refrigeración de 2 y 3 puertas.

La gama Concept se caracteriza por ser la línea más económica pero, con una amplitud de gama única en el mercado (series GN-700, Snack-600 y Pastelería) gracias a las diferentes opciones disponibles.

	GASTRONORM - 700		SNACK - 600	PASTELERÍA - 800
	GLOBE ADVANCE	GLOBE CONCEPT	GLOBE CONCEPT	GLOBE CONCEPT
Dimensiones (3 puertas)	1.800 x 700 x 850	1.792 x 700 x 850	2.017 x 600 x 850	2.017 x 800 x 850
CAPACIDAD (Nº niveles por puerta)	6	6	3	10
CLASE DE EFICIENCIA ENERGÉTICA	A	B	C	C
Aislamiento	Lateral 60 mm Doble techo de 50+40 mm	50 mm	50 mm	50 mm
Refrigerante	R600a / R290	R600a / R290	R600a / R290	R600a
Clase climática	5	4	4	4
Sistema de refrigeración	TIRO FORZADO	TIRO FORZADO	TIRO FORZADO	GRAVEDAD
HACCP	SI	NO	NO	NO
Modo ECO	SI	SI	SI	SI
CERRADURA	OPCIONAL De serie con puertas de cristal	OPCIONAL De serie con puertas de cristal	OPCIONAL De serie con puertas de cristal	OPCIONAL
GRADO DE PROTECCIÓN DE HUMEDAD	IPX4	IPX4	IPX4	IPX4

ADVANCE | 700 Gastronorm

Las mesas ADVANCE, disponibles en fondo 700 mm y para recipientes de tamaño Gastronorm, se han diseñado pensando en ofrecer un producto más eficiente, rentable y sostenible que mejore las condiciones del trabajo diario.



REDUCCIÓN DEL
CONSUMO HASTA
UN 45 %.

Características generales

- Interior y exterior completamente construido con AISI-304.
- Estructura completamente inyectada con poliuretano de 40 kg/m³ de densidad. 60 mm de espesor en los laterales y area posterior, mientras que el techo y fondo tienen 50 mm con una encimera inyectada de 30 mm de espesor (80mm en total).
- Evaporador de tubo de cobre y aletas de aluminio.
- Sistema HACCP que registra el historial de funcionamiento.
- Control electrónico y digital de la temperatura y del desescarche con visor digital.
- El control se halla integrado en el panel frontal estando así más protegido contra la suciedad y tiene el grado oficial de protección IPX5 contra posibles salpicaduras y chorros de agua.

- Mecanismo de cierre y bloqueo automático de las puertas, que ayuda a aumentar la comodidad a la hora de cargar y descargar el equipo.
- Estantes de acero plastificado fácilmente desmontables para su limpieza con guías regulables en altura (tamaño GN1/1).
- Dotación por puerta: 1 parrilla GN 1/1 y 2 juegos de guías para su colocación a diferentes alturas.
- Desagüe integrado mediante embutición que permite evacuar las aguas residuales que puedan producirse en el interior del mueble.
- Fondo con interiores curvos para facilitar la limpieza y conservación.
- Iluminación interior LED (sólo para modelos con puertas de cristal).
- Patas de acero inoxidable regulables en altura.
- Peto sanitario de 10 cm de altura.
- Temperatura de trabajo: 0 °C, +8 °C (refrigeradores) y -18 °C, -22 °C (congeladores).

- Testeado en Clase climática V.

Opciones:

- Kit ruedas (montaje en fábrica).
- Sin peto.
- Sin encimera.
- Diferentes versiones de cajones.
- Apertura de puerta panorámica.
- Posterior INOX.
- Encimera de granito.
- Resistencia marco puerta que evita condensaciones en ambientes de elevada humedad (std en modelos de congelación).
- Cerradura (de serie en puertas de cristal).

Mesas de refrigeración *

Mesas para congelados

Mesas de refrigeración con puertas de cristal

Mesas centrales de refrigeración



ACP-4G

ACN-3G



ACP-2G GD













ACP-4G

(*) Ofrecemos la posibilidad de tener encimera de granito en las mesas de refrigeración.

(*) Ofrecemos la posibilidad de apertura de puerta panorámica en modelos de 2, 3, y 4 puertas (sólo puertas sólidas).

VISIBILIDAD:
Doble cristal en la puerta y marco de aluminio anodizado con doble cámara de vacío.

FLEXIBILIDAD:
Incluye puertas a ambos lados que aportan mayor flexibilidad en el trabajo.

MODELO	HZ	CÓDIGO	Nº PUERTAS	CLASE DE EFICIENCIA ENERGÉTICA	CAPACIDAD BRUTA (L)	CONSUMO ENERGÉTICO ANUAL (KW-H)	POTENCIA ELÉCTRICA (W)	REFRIGERANTE	DIMENSIONES (mm)	€
Mesas de refrigeración										
 ACP-2G	50	19089528	2	A	300	381	159	R600a	1.342x700x850	2.884
 ACP-3G	50	19089529	3	A	450	514	159	R600a	1.792x700x850	3.344
 ACP-4G	50	19089530	4	B	600	810	159	R600a	2.242x700x850	3.885
Mesas para congelados										
 ACN-2G	50	19089531	2	D	300	2.044	307	R290	1.342x768x850	3.551
	60	19089532		-		-	348			3.623
 ACN-3G	50	19089533	3	D	450	2.654	316	R290	1.792x768x850	4.180
	60	19089534		-		-	357			4.264
ACN-4G	50	19089055	4	D	600	3.322	325	R290	2242 x 768 x 850	4.818
	60	19096650		-		-	366			4.914
Mesas de refrigeración con puertas de cristal										
 ACP-2G GD	50	19089535	2	B	300	609	159	R600a	1.342x700x850	3.298
 ACP-3G GD	50	19089536	3	B	450	822	159	R600a	1.792x700x850	3.965
 ACP-4G GD	50	19089537	4	B	600	1296	159	R600a	2.242x700x850	4.713
Mesas centrales de refrigeración										
 ACP-2G/C	50	19089538	2+2	-	300	-	159	R600a	1.342x768x850	3.525
 ACP-3G/C	50	19089539	3+3	-	450	-	159	R600a	1.792x768x850	4.307
 ACP-4G/C	50	19089540	4+4	-	600	-	159	R600a	2242 x 768 x 850	5.169

CONCEPT | 700 Gastronorm

Con la gama CONCEPT de fondo 700 mm y con capacidad para recipientes Gastronorm, presentamos uno de los catálogos más amplios del mercado en mesas frigoríficas. Ofrecemos un amplio abanico de versiones y opciones para adaptarnos a las necesidades de cada usuario, con un producto robusto, ergonómico, funcional y de fácil limpieza.



REDUCCIÓN DEL
CONSUMO HASTA
UN 35 % CON
GASES HC

Características Generales

- Interior y exterior en acero inoxidable austenítico de alta calidad (excepto respaldo en galvanizado).
- 50 mm de aislamiento de poliuretano inyectado de 40 kg/m³ de densidad.
- Sistema de refrigeración por tiro forzado colocado en el interior de la cámara.
- Evaporador de tubo de cobre y aletas de aluminio.
- Control electrónico y digital de la temperatura y del desescarche con visor digital.
- El control se halla integrado en el panel frontal estando así más protegido contra la suciedad y tiene el grado oficial de protección IPX5 contra posibles salpicaduras y chorros de agua.
- Alarma para evitar una apertura prolongada de la puerta.
- Mecanismo de cierre y bloqueo automático de las puertas, que ayuda a aumentar la comodidad a la hora de cargar y descargar el equipo.
- Estantes de acero plastificado fácilmente desmontables para su limpieza con guías regulables en altura (tamaño GN1/1).
- Dotación por puerta: 1 parrilla GN 1/1 y 2 juegos de guías para su colocación a diferentes alturas.
- Desagüe integrado mediante embutición que permite evacuar las aguas residuales que puedan producirse en el interior del mueble.
- Fondo embutido e interiores curvos para facilitar la limpieza y conservación.
- Iluminación interior LED (sólo para modelos con puertas de cristal).
- Patas de acero inoxidable regulables en altura.
- Peto sanitario de 10 cm de altura.
- Temperatura de trabajo: 0 °C, +8 °C (refrigeradores) y -18 °C, -22 °C (congeladores).

Opciones:

- Kit ruedas (montaje en fábrica).
- Sin peto.
- Sin encimera.
- Diferentes versiones de cajones.
- Grupo a la izquierda.
- Apertura de puerta panorámica.
- Posterior INOX.
- Encimera de granito.
- Resistencia marco puerta que evita condensaciones en ambientes de elevada humedad (std en modelos de congelación).
- Cerradura (de serie en puertas de cristal).

Mesas estándar para congelados

Mesas para congelados







CCN-3G



CCN-2G/R

ADAPTABILIDAD:
Equipos preparados para conexión de grupo frigorífico a distancia.
El grupo de refrigeración no se incluye.

MODELO	REFRIGERANTE	HZ.	CÓDIGO	Nº DE PUERTAS	CLASE EFICIENCIA ENERGÉTICA	CAPACIDAD BRUTA (L)	CONSUMO ENERGÉTICO ANUAL (KW-H)	POTENCIA ELÉCTRICA (W)	DIMENSIONES (mm)	€
Mesas para congelados										
	CCN-2G	R290	50	19089561	D	274	2.212	667	1.342x700x850	2.896
			60	19089562			-	737		2.954
	CCN-3G	R290	50	19089563	D	428	2.467	676	1.792x700x850	3.281
			60	19089564			-	746		3.346
Mesas para congelados con preinstalación										
	CCN-2G/R		50/60	19089565	-	274	-	414	1.042x700x850	2.260
	CCN-3G/R		50/60	19089566	-	428	-	423	1.492x700x850	2.645

Concept | 600 Snack

Nuestra gama CONCEPT de fondo 600 mm y en dimensiones Snack ofrece un amplio catálogo de mesas frigoríficas que se adaptan a espacios reducidos, con un producto robusto, ergonómico, funcional y de fácil limpieza.



REDUCCIÓN DEL
CONSUMO HASTA
UN 60 % CON
GASES HC

Características Generales

- Interior y exterior en acero inoxidable austenítico de alta calidad.
- 50 mm de aislamiento de poliuretano inyectado de 40 kg/m³ de densidad.
- Sistema de refrigeración por tiro forzado colocado en el interior de la cámara.
- Evaporador de tubo de cobre y aletas de aluminio.
- Control electrónico y digital de la temperatura y del desescarche con visor digital.
- Mecanismo de cierre y bloqueo automático de las puertas, que ayuda a aumentar la comodidad a la hora de cargar y descargar el equipo.
- Estantes de acero plastificado fácilmente desmontables para su limpieza con guías regulables en altura. Dimensiones del estante parrilla: 405 x 460 mm.
- Dotación 1 parrilla por puerta y 1 juego de guías.
- Desagüe integrado mediante embutición que permite evacuar las aguas residuales que puedan producirse en el interior del mueble.
- Fondo embutido e interiores curvos para facilitar la limpieza y conservación.
- Iluminación interior LED (sólo para modelos con puertas de cristal).
- Patas de acero inoxidable regulables en altura.
- Peto sanitario de 10 cm de altura.
- Temperatura de trabajo: 0°C, +8 °C (refrigeradores) y -18 °C, -22 °C (congeladores).
- Testeado en clase climática 4.

Opciones:

- Kit ruedas (montaje en fábrica).
- Sin peto.
- Sin encimera.
- Diferentes versiones de cajones.
- Grupo a la izquierda.
- Apertura de puerta panorámica.
- Posterior INOX.
- Cerradura (de serie en puertas de cristal).
- Resistencia marco puerta que evita condensaciones en ambientes de elevada humedad (std. en mesas de congelación).



Mesas estándar para congelados

Mesas para congelados



CCN - 3S

Mesas para congelados con preinstalación (*)



CCN- 2S/R

(*) ADAPTABILIDAD
Equipos preparados para conexión de grupo frigorífico a distancia.
El grupo de refrigeración no se incluye.









MODELO	REFRIGERANTE	HZ.	CÓDIGO	Nº DE PUERTAS	CLASE EFICIENCIA ENERGÉTICA	CAPACIDAD BRUTA (L)	CONSUMO ENERGÉTICO ANUAL (KW-H)	POTENCIA ELÉCTRICA (W)	DIMENSIONES (mm)	€
Mesas para congelados										
	CCN-2S	R290	50	19089634	D	268	2.212	669	1.492x600x850	2.780
			60	19089635	-		-	739		2.836
	CCN-3S	R290	50	19089636	D	416	2.467	679	2.017x600x850	3.150
			60	19089637	-		-	749		3.213
Mesas para congelados con preinstalación										
	CCN-2S/R	-	50/60	19089638	-	268	-	416	1.192x600x850	2.145
	CCN-3S/R	-	50/60	19089639	-	416	-	426	1.717x600x850	2.514

MESAS REFRIGERADAS 600 GAMA UNICO

F

ALTO RENDIMIENTO

SPECIAL voltage +5%

	MODELO	°C	DOTAC.	LIT	DIMENS INTERIORES	DIMENS EXTERIOR	W	V/Hz	REFRIG	PVP	
	MCS 1500	-2°/+8°	2	250	95x44x60	150x60x92	442	230V F+N 50Hz	134a	2.345€	
	MNS 1500	-18°	2	250	95x44x60	150x60x92	522	230V F+N 50Hz	452a	2.950€	
	MCS 2000	-2°/+8°	3	395	148x44x60	202x60x92	442	230V F+N 50Hz	134a	2.815€	
	MNS 2000	-18°	3	395	148x44x60	202x60x92	522	230V F+N 50Hz	452a	3.990€	
	MCS 2500	-2°/+8°	4	540	199x44x60	254x60x92	761	230V F+N 50Hz	134a	3.215€	
	MNS 2500	-18°	4	540	199x44x60	254x60x92	761	230V F+N 50Hz	452a	3.990€	
	MCS 1500 F	-2°/+8°	2	250	95x44x60	150x60x92	442	230V F+N 50Hz	134a	2.495€	
	MNS 1500 F	-18°	2	250	95x44x60	150x60x92	522	230V F+N 50Hz	452a	3.170€	
	CON FREGADERO / WITH SINK / AVEC ÉVIER										
	MCS 2000 F	-2°/+8°	3	395	148x44x60	202x60x92	442	230V F+N 50Hz	134a	2.965€	
	MNS 2000 F	-18°	3	395	148x44x60	202x60x92	522	230V F+N 50Hz	452a	3.610€	
	CON FREGADERO / WITH SINK / AVEC ÉVIER										
	MCS 2500 F	-2°/+8°	4	540	199x44x60	254x60x92	761	230V F+N 50Hz	134a	3.365€	
	MNS 2500 F	-18°	4	540	199x44x60	254x60x92	761	230V F+N 50Hz	452a	4.210€	
	CON FREGADERO / WITH SINK / AVEC EVIER										

Construidas en acero inoxidable 304, excepto trasera y fondo exterior. Aislamiento de poliuretano inyectado, a alta densidad, libre de CFC. Ventilación sólo frontal, que permite encastrar o adherir a otros muebles. Puertas de ancho especial para facilitar el acceso (435*530 mm h). Equipo frío accesible al 100%. Tropicalizado, de alto rendimiento, con evaporador interior y desescarche automático por resistencia. Parrilla fija. Puertas higiénicas sin tiradores. Desagüe en la cuba.

BAJOS H=65 GAMA UNICO

ALTO RENDIMIENTO

	MODELO	°C	PTAS	CAJONES	DIMENS INTERIORES	DIMENS EXTERIOR	W	V/Hz	REFRIG	PVP
	BCS 1504 SPCJ	0°C/6°C	-	2x2	95x44x40	150x60x65	442	230V F+N 50 Hz	134a	3.355€
	BCS 2006 SPCJ	0°C/6°C	-	2x3	148x44x40	202x60x65	442	230V F+N 50 Hz	134a	4.230€
	BCS 2508 SPCJ	0°C/6°C	-	2x4	199x44x40	254x60x65	761	230V F+N 50 Hz	134a	4.995€

Construidas en acero inoxidable 304, excepto trasera y fondo exterior. Aislamiento de poliuretano inyectado, a alta densidad, libre de CFC. Ventilación sólo frontal, que permite encastrar o adherir a otros muebles. Cajones higiénicos, sin tiradores, con altura útil de 106mm, que rentabilizan el espacio al máximo. Equipo frío accesible al 100%. Tropicalizado, de alto rendimiento, con evaporador vertical y desescarche automático por resistencia. Desagüe en la cuba.

MESAS REFRIGERADAS GN 1/1 GAMA UNICO

ALTO RENDIMIENTO

SPECIAL voltage +5%

	MODELO	°C	DOTAC.	LIT	DIMENS INTERIORES	DIMENS EXTERIOR	W	V/Hz	REFRIG	PVP
	MCG 1500	-2°/+8°	2	285	84x52x60	139x70x92	442	230V F+N 50Hz	134a	2.375€
	 MNG 1500	-18°	2	285	84x52x60	139x70x92	522	230V F+N 50Hz	452a	3.075€
	MCG 2000	-2°/+8°	3	450	131x52x60	186x70x92	442	230V F+N 50Hz	134a	2.855€
	 MNG 2000	-18°	3	450	131x52x60	186x70x92	527	230V F+N 50Hz	452a	3.650€
	MCG 2500	-2°/+8°	4	600	178x52x60	233x70x92	761	230V F+N 50Hz	134a	3.305€
	 MNG 2500	-18°	4	600	178x52x60	233x70x92	761	230V F+N 50Hz	452a	4.195€
	MCG 1500 C	-2°/+8°	2	285	84x52x60	139x70x92	442	230V F+N 50Hz	134a	2.775€
PUERTAS CRISTAL Y LUZ / WITH GLASS DOOR AND LED / PORTES VERRE ET LED										
	MCG 2000 C	-2°/+8°	3	450	131x52x60	186x70x92	442	230V F+N 50Hz	134a	3.395€
PUERTAS CRISTAL Y LUZ / WITH GLASS DOOR AND LED / PORTES VERRE ET LED										
	MCG 2500 C	-2°/+8°	4	600	178x52x60	233x70x92	761	230V F+N 50Hz	134a	3.860€
PUERTAS CRISTAL Y LUZ / WITH GLASS DOOR AND LED / PORTES VERRE ET LED										
	MCG 1500 F	-2°/+8°	2	285	84x52x60	139x70x92	442	230V F+N 50Hz	134a	2.595€
	 MNG 1500 F	-18°	2	285	84x52x60	139x70x92	522	230V F+N 50Hz	452a	3.295€
CON FREGADERO / WITH SINK / AVEC EVIER										
	MCG 2000 F	-2°/+8°	3	450	131x52x60	186x70x92	442	230V F+N 50Hz	134a	3.075€
	 MNG 2000 F	-18°	3	285	131x52x60	186x70x92	527	230V F+N 50Hz	452a	3.870€
CON FREGADERO / WITH SINK / AVEC EVIER										
	MCG 2500 F	-2°/+8°	4	600	178x52x60	233x70x92	761	230V F+N 50Hz	134a	3.525€
	 MNG 2500 F	-18°	4	600	178x52x60	233x70x92	761	230V F+N 50Hz	452a	4.420€
CON FREGADERO / WITH SINK / AVEC EVIER										

Construidas en acero inoxidable 304, excepto trasera y fondo exterior. Aislamiento de poliuretano inyectado, a alta densidad, libre de CFC. Ventilación sólo frontal, que permite encastrar o adherir a otros muebles.

Equipo frío accesible al 100%. Tropicalizado, de alto rendimiento, con evaporador interior y desescarche automático por resistencia. Guías inox con parrillas extraíbles y móviles que permiten un máximo aprovechamiento.

Puertas higiénicas sin tiradores (luz 370*530 mm h). Desagüe en la cuba.

MESAS 800 EURONORM 60X40 GAMA UNICO

SPECIAL voltage +5%





F

	MODELO	°C	BANDEJ DOTAC.	LIT	DIMENS INTERIOR	DIMENS EXTERIOR	W	V/Hz	REFRIG	PVP
	MCE 1500 SP	-2°/+8°	2	360	95x62x60	150x80x85	442	230V F+N 50Hz	134a	2.685€
	 MNE 1500 SP	-18°	2	360	95x62x60	150x80x85	522	230V F+N 50Hz	452a	3.450€
	ENCIMERA GRANITO 1500									520€
	MCE 2000 SP	-2°/+8°	3	550	148x62x60	202x80x85	761	230V F+N 50Hz	134a	3.210€
	 MNE 2000 SP	-18°	3	550	148x62x60	202x80x85	761	230V F+N 50Hz	134a	4.010€
	ENCIMERA GRANITO 2000									700€
	MCE 2500 SP	-2°/+8°	4	740	199x62x60	254x80x85	761	230V F+N 50Hz	740	3.780€
	 MNE 2500 SP	-18°	4	740	199x62x60	254x80x85	761	230V F+N 50Hz	452a	4.715€
	ENCIMERA GRANITO 2500									870€

Construidas en acero inoxidable 304, excepto trasera y fondo exterior. Aislamiento de poliuretano inyectado, al alta densidad, libre de CFC. Ventilación sólo frontal, que permite encastrar o adherir a otros muebles. Equipo frio accesible al 100%. Tropicalizado, de alto rendimiento, con evaporador interior y desescarche automático por resistencia. Guías inox con bandejas aluminio 60*40 extraibles y móviles que permiten un máximo aprovechamiento. Puertas higiénicas sin tiradores (luz 370*530 mm h). Desagüe en la cuba.

FRENTE MOSTRADORES 600 GAMA UNICO

	MODELO	°C	PARRI. DOT	LIT	DIMENS. INTERIOR	DIMENS. EXTERIOR	W	V/Hz	REFRIG	PVP
	FMC 1500	0°C/6°C	2	330	95x44x80	150x60x110	442	230V F+N 50Hz	134a	2.450€
	FMC 1500 C (CRISTAL LUZ)		2	330	95x44x80	150x60x110	442	230V F+N 50Hz	134a	2.775€
	FMC 2000	0°C/6°C	3	540	148x44x80	202x60x110	761	230V F+N 50Hz	134a	2.980€
	FMC 2000 C (CRISTAL LUZ)		3	540	148x44x80	202x60x110	761	230V F+N 50Hz	134a	3.395€
	FMC 2500	0°C/6°C	4	730	199x44x80	254x60x110	761	230V F+N 50Hz	134a	3.380€
	FMC 2500 C (CRISTAL LUZ)		4	730	199x44x80	254x60x110	761	230V F+N 50Hz	134a	3.860€

Construidas en acero inoxidable 304, excepto trasera y fondo exterior. Aislamiento de poliuretano inyectado, a alta densidad, libre de CFC. Ventilación sólo frontal, que permite encastrar o adherir a otros muebles. Puertas de ancho especial para facilitar el acceso (435*730 mm h). Equipo frio accesible al 100%. Tropicalizado, de alto rendimiento, con evaporador interior y desescarche automático por resistencia. Parrilla fija. Puertas higiénicas sin tiradores. Desagüe en la cuba.

Tavoli refrigerati gastronomia GN1/1 - ventilati e linea snack

IT Gruppo incorporato estraibile per facile manutenzione - andamento circolare dell'aria fredda in modo da non toccare direttamente il prodotto - controllo temperatura elettronico con termostato digitale - resistenza elettrica intorno alla cornice porta per eliminazione della condensa - sbrinamento automatico con resistenza elettrica e controllo automatico della temperatura di sbrinamento - evaporazione automatica dell'acqua di condensa - evaporatore trattato anticorrosione. Porta con molla di ritorno - guarnizione porta estraibile senza utensili - fondo con angoli arrotondati - facile intercambiabilità porte con cassetiere da due e tre cassetti - cassetiere facilmente estraibili con guide telescopiche in acciaio inox. Piedini in acciaio Inox regolabili in altezza - possibilità di appoggio al muro.

EN Built-in extractable unit for easy maintenance - circular cold air flow to avoid direct impact on the product - electronic temperature control with digital thermostat - electrical heating element around the door frame to prevent condensation - automatic defrosting with electrical heating element and automatic defrosting temperature control - automatic evaporation of condensate water - anti-corrosion treated evaporator. Door with self-closing spring - tool-free extractable door gasket - bottom with rounded corners - easy substitution of doors with two or three drawer units - easily extractable drawer units with stainless steel telescopic slides. Height-adjustable feet in stainless steel - can be placed against the wall.

FR Unité extractible intégrée pour un entretien facile - flux d'air froid circulaire pour ne pas toucher directement le produit - régulation électronique de la température avec thermostat digital - résistance électrique autour du cadre de la porte pour éliminer la condensation - dégivrage automatique avec résistance électrique et régulation automatique de la température de dégivrage - évaporation automatique de l'eau de condensation - évaporateur traité anticorrosion. Porte avec ressort auto-fermant - joint de porte extractible sans outils - fond avec coins arrondis - remplacement aisé des portes par éléments de deux ou trois tiroirs - blocs-tiroirs amovibles avec glissières télescopiques en acier inox. Pieds en acier inox réglables en hauteur - peut être placé contre le mur.

ES Unidad extraíble incorporada para un fácil mantenimiento - circuito de aire frío circular para evitar el impacto directo sobre el producto - control de temperatura electrónico con termostato digital - elemento de calefacción eléctrico alrededor del marco de la puerta para evitar la condensación - descongelación automática con elemento de calefacción eléctrico y control automático de la temperatura de descongelación - evaporación automática del agua condensada - evaporador con tratamiento anticorrosivo. Puerta con muelle de cierre automático - junta de la puerta extraíble sin herramientas - fondo con esquinas redondeadas - fácil sustitución de puertas por unidades de dos o tres cajones - cajones fáciles de extraer con correderas telescópicas de acero inoxidable. Patas de altura regulable en acero inoxidable - pueden colocarse contra la pared

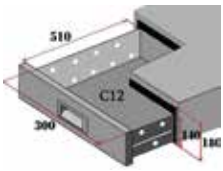
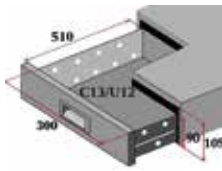
Optional	CG11-FC	GRP11-FC	C12-FC mod. TN	C13-FC mod. TN	CGG mod. SNACK	GRPG mod. SNACK 33x43 cm
	<p>Coppia guide per griglia Pair of slides for grid Paire de glissières pour grille Par de guías para rejilla</p>	<p>Griglia plastificata Plastic coated grid Grille plastifiée Rejilla plastificada</p>	<p>Set. 2 cassetti / drawers Set. 2 tiroirs / cajones</p> 	<p>Set. 3 cassetti / drawers Set. 3 tiroirs / cajones</p> 	<p>Coppia guide per griglia Pair of slides for grid Paire de glissières pour grille Par de guías para rejilla</p>	<p>Griglia plastificata Plastic coated grid Grille plastifiée Rejilla plastificada</p>
	25 €	20 €	460 €	670 €	25 €	20 €

G-GN2100TN-FC / G-GN2100BT-FC























G-GN3100TN-FC / G-GN3100BT-FC























G-GN4100TN-FC / G-GN4100BT-FC



	G-GN2100TN-FC	G-GN2100BT-FC
	-2°C / +8°C	-18°C / -22°C
	1360 x 700 x 850(h) mm	1360 x 700 x 850(h) mm
	900 x 530 x 560(h) mm	900 x 530 x 560(h) mm
	282 L	282 L
	+35°C / 50%HR	+35°C / 50%HR
	ventilata / ventilated	ventilata / ventilated
DEFROST	elettrico / electric	elettrico / electric
GAS	R600a	R290
	automatica / automatic	automatica / automatic
	elettronico / electronic	elettronico / electronic
CONTROL		
	60 mm	60 mm
	275 W	675 W
	230V / 50Hz	230V / 50Hz
MATERIAL	acciaio Inox / stainless steel	acciaio Inox / stainless steel
	no	no
	no	no
STANDARD	2 griglie / grids GN1/1 2 coppie di guide / pairs of slides	2 griglie / grids GN1/1 2 coppie di guide / pairs of slides
ENERGY CLASS		
	92 Kg	94 Kg
	106 Kg	109 Kg
	1390 X 730 x 880(h) mm	1390 x 730 x 880(h) mm
	2135,20 €	2611,20 €

	G-GN3100TN-FC	G-GN3100BT-FC
	-2°C / +8°C	-18°C / -22°C
	1795 x 700 x 850(h) mm	1795 x 700 x 850(h) mm
	1335 x 530 x 560(h) mm	1335 x 530 x 560(h) mm
	417 L	417 L
	+35°C / 50%HR	+35°C / 50%HR
	ventilata / ventilated	ventilata / ventilated
DEFROST	elettrico / electric	elettrico / electric
GAS	R600a	R290
	automatica / automatic	automatica / automatic
	elettronico / electronic	elettronico / electronic
	60 mm	60 mm
	275 W	675 W
	230V / 50Hz	230V / 50Hz
MATERIAL	acciaio Inox / stainless steel	acciaio Inox / stainless steel
	no	no
	no	no
STANDARD	3 griglie / grids GN1/1 3 coppie di guide / pairs of slides	3 griglie / grids GN1/1 3 coppie di guide / pairs of slides
ENERGY CLASS		
		
	114 Kg	124 Kg
	126 Kg	139 Kg
	1825 x 730 x 880(h) mm	1825 x 730 x 880(h) mm
	2516 €	2992 €

	G-GN4100TN-FC	G-GN4100BT-FC
	-2°C / +8°C	-18°C / -22°C
	2230 x 700 x 850(h) mm	2230 x 700 x 850(h) mm
	1772 x 630 x 560(h) mm	1772 x 630 x 560(h) mm
	553 L	553 L
	+35°C / 50%HR	+35°C / 50%HR
	ventilata / ventilated	ventilata / ventilated
DEFROST	elettrico / electric	elettrico / electric
GAS	R290	R290
	automatica / automatic	automatica / automatic
	elettronico / electronic	elettronico / electronic
	60 mm	60 mm
	398 W	675 W
	230V / 50Hz	230V / 50Hz
MATERIAL	acciaio Inox / stainless steel	acciaio Inox / stainless steel
	no	no
	no	no
STANDARD	4 griglie / grids GN1/1 4 coppie di guide / pairs of slides	4 griglie / grids GN1/1 4 coppie di guide / pairs of slides
ENERGY CLASS		
		
	132 Kg	147 Kg
	153 Kg	168 Kg
	2260 x 760 x 880(h) mm	2260 x 760 x 880(h) mm
	2978,40 €	3386,40 €

Tavoli refrigerati gastronomia - GN1 /1 - ventilati / Gastronomy refrigerated counters - GN1/1 - ventilated
 Tables réfrigérées gastronomie - GN1/1 - ventilées / Mostradores refrigerados para alimentación - GN1/1 - ventilados

Los precios de este catálogo pueden estar desactualizados. Llámanos al 91 161 03 04 para consultar los precios en vigor.

G-GN2200TN-FC / G-GN2200BT-FC























G-GN3200TN-FC / G-GN3200BT-FC























G-GN4200TN-FC / G-GN4200BT-FC



	G-GN2200TN-FC	G-GN2200BT-FC
	-2°C / +8°C	-18°C / -22°C
	1360 x 700 x 950(h) mm	1360 x 700 x 950(h) mm
	900 x 530 x 560(h) mm	900 x 530 x 560(h) mm
	282 L	282 L
	+35°C / 50%HR	+35°C / 50%HR
	ventilata / ventilated	ventilata / ventilated
DEFROST	elettrico / electric	elettrico / electric
GAS	R600a	R290
	automatica / automatic	automatica / automatic
	elettronico / electronic	elettronico / electronic
CONTROL		
	60 mm	60 mm
	275 W	675 W
	230V / 50Hz	230V / 50Hz
MATERIAL	acciaio Inox / stainless steel	acciaio Inox / stainless steel
	no	no
	no	no
STANDARD	2 griglie / grids GN1/1 2 coppie di guide / pairs of slides	2 griglie / grids GN1/1 2 coppie di guide / pairs of slides
ENERGY CLASS		
	92 Kg	94 Kg
	106 Kg	109 Kg
	1390 x 730 x 970(h) mm	1390 x 730 x 970(h) mm
	2189,60 €	2665,60 €

	G-GN3200TN-FC	G-GN3200BT-FC
	-2°C / +8°C	-18°C / -22°C
	1795 x 700 x 950(h) mm	1795 x 700 x 950(h) mm
	1335 x 530 x 560(h) mm	1335 x 530 x 560(h) mm
	417 L	417 L
	+35°C / 50%HR	+35°C / 50%HR
	ventilata / ventilated	ventilata / ventilated
DEFROST	elettrico / electric	elettrico / electric
GAS	R600a	R290
	automatica / automatic	automatica / automatic
	elettronico / electronic	elettronico / electronic
	60 mm	60 mm
	275 W	675 W
	230V / 50Hz	230V / 50Hz
MATERIAL	acciaio Inox / stainless steel	acciaio Inox / stainless steel
	no	no
	no	no
STANDARD	3 griglie / grids GN1/1 3 coppie di guide / pairs of slides	3 griglie / grids GN1/1 3 coppie di guide / pairs of slides
ENERGY CLASS		
		
	114 Kg	124 Kg
	126 Kg	139 Kg
	1825 x 730 x 970(h) mm	1825 x 730 x 970(h) mm
	2584 €	3060 €

	G-GN4200TN-FC	G-GN4200BT-FC
	-2°C / +8°C	-18°C / -22°C
	2230 x 700 x 950(h) mm	2230 x 700 x 950(h) mm
	1772 x 630 x 560(h) mm	1772 x 630 x 560(h) mm
	553 L	553 L
	+35°C / 50%HR	+35°C / 50%HR
	ventilata / ventilated	ventilata / ventilated
DEFROST	elettrico / electric	elettrico / electric
GAS	R290	R290
	automatica / automatic	automatica / automatic
	elettronico / electronic	elettronico / electronic
	60 mm	60 mm
	398 W	675 W
	230V / 50Hz	230V / 50Hz
MATERIAL	acciaio Inox / stainless steel	acciaio Inox / stainless steel
	no	no
	no	no
STANDARD	4 griglie / grids GN1/1 4 coppie di guide / pairs of slides	4 griglie / grids GN1/1 4 coppie di guide / pairs of slides
ENERGY CLASS		
		
	132 Kg	147 Kg
	153 Kg	168 Kg
	2260 x 730 x 970(h) mm	2260 x 730 x 970(h) mm
	3060 €	3468 €



















Tavoli refrigerati gastronomia - GN1 /1 - ventilati / Gastronomy refrigerated counters - GN1/1 - ventilated
 Tables réfrigérées gastronomie - GN1/1 - ventilées / Mostradores refrigerados para alimentación - GN1/1 - ventilados

Los precios de este catálogo pueden estar desactualizados. Llámanos al 91 161 03 04 para consultar los precios en vigor.

+Info: www.infrico.com



































Serie / Series / Série

600

					
BMPP 1500 II	BMPP 2000 II	BMPP 2500 II	BMPP 1500 BT	BMPP 2000 BT	BMPP 2500 BT
REFRIGERACIÓN / REFRIGERATOR / POSITIVE			CONGELACIÓN / FREEZER / NÉGATIVE		
Fregadero / Sink / Evier					
					
BMPP 1500 CR	BMPP 2000 CR	BMPP 2500 CR	BMPPF 1500 II	BMPPF 2000 II	BMPPF 2500 II
REFRIGERACIÓN / REFRIGERATOR / POSITIVE			REFRIGERACIÓN / REFRIGERATOR / POSITIVE		
					
BMPP 1500 GR	BMPP 2000 GR	BMPP 1500 GRBT	BMPP 2000 GRBT	BMPP 1500 EN	BMPP 2000 EN
REFRIG / REFRIG / POSIT		CONGELACIÓN / FREEZER / NÉGATIVE		REFRIG / REFRIG / POSIT	

Serie / Series / Série

GN1/1700

							
MSG 1000	MSG 1400	MSG 1600	MSG 2000	MSG 2400			
REFRIGERACIÓN / REFRIGERATOR / POSITIVE			CONGELACIÓN / FREEZER / NÉGATIVE				
							
BMGN 1470 II	BMGN 1960 II	BMGN 2450 II	BMGN 1470 BT	BMGN 1960 BT	BMGN 2450 BT		
REFRIGERACIÓN / REFRIGERATOR / POSITIF			CONGELACIÓN / FREEZER / NÉGATIVE				
F= Fregadero / Sink / Evier							
							
BMGN 1470 CR	BMGN 1960 CR	BMGN 2450 CR	BMGN 1470 F	BMGN 1960 F	BMGN 2450 F		
REFRIGERACIÓN / REFRIGERATOR / POSITIVE							
Pasante/Pass-thru/Traversante							
							
BMGN1470GR	BMGN1960GR	BMGN2450GR	BMGN1470GRBT	BMGN1960GRBT	BMGN2450GRBT	BMGN1470PDC	BMGN1960PDC
REFRIG / REFRIG / POSIT			CONGELACIÓN / FREEZER / NÉGATIVE			REFRIG / REFRIG / POSIT	
Ensalada / Salad / Salade			Ensalada / Salad / Salade				
							
BMGN 1470 EN	BMGN 1960 EN	MPG 1490	MPG 1980	ME 1003 VIP			
REFRIGERACIÓN / REFRIGERATOR / POSITIVE							
Ensalada / Salad / Salade							
							
ME 1000 BAN	ME 1000 EN	ME 1000 II	ME 1000 PIZZA	ME 1000 KB			
REFRIGERACIÓN / REFRIGERATOR / POSITIVE							

Los datos técnicos están sujetos a posibles variaciones que serán actualizadas periódicamente en las fichas técnicas del producto, disponibles en la web / The technical data are subject to possible variations that will be updated periodically in the technical data sheets of the product, which are available on the website / Les données techniques peuvent varier et seront actualisées dans les fiches techniques du produit, disponibles sur le site web.

2. Mesas





Undercounters / Tables

Serie / Series / Série		
800	Mesa refrigeración y congelación euronorma 600 x 400 para pastelería Euronorm 600 x 400 refrigerator counter / Tour pâtissier positif et négatif Euronorme 600x400	82 - 83
	Mesa refrigeración euronorma 600 x 400 puerta de cristal Glass door euronorm 600x400 counter refrigerator / Tour pâtissier positif Euronorme 600x400 portes vitrées	84 - 85
	Mesa refrigeración euronorma 600 x 400 remota Euronorm 600x400 remote counter refrigerator / Tour pâtissier positif Euronorme 600x400 groupe à distance	84 - 85
	Mesa refrigerada central euronorma 600 x 400 puertas a dos caras cristal Pass thru counter refrigerator / Tour pâtissier positif Euronorme 600x400 traversante	86 - 87
	Mesa refrigerada euronorma 600 x 400 para ensaladas, pizza y pastelería Euronorma 600 x 400 salads, pizza & pastry drep refrigerator counter Table positive Euronorme 600x400 préparation salades, pizzas et pâtisseries	86 - 87
Serie / Series / Série		
MEV800	Mesa y bandeja superior refrigeradas para ensaladas y pizza Salads-pizza prep refrigerator table Table et compartiment superieur réfrigéré pour préparation salades et pizzas	88 - 89
Serie / Series / Série		
MPL800	Mesa refrigerada pizza Lucena Pizza prep table / Table positive pizza et fast food Lucena	88 - 89
Serie / Series / Série		
MP800	Mesa refrigerada pizza Pizza prep table / Table positive pizza	90 - 91
Serie / Series / Série		
FMPP	Frente mostrador refrigerado Back bar counter refrigerator / Desserte arrière bar positive cafétéria	92 - 93
	Frente mostrador refrigerado preinstalado Remote back-bar counter refrigerator / Desserte arrière bar positive groupe à distance cafétéria	92 - 93
	Frente mostrador refrigerado con cajones Drawers back-bar counter refrigerator / Desserte arrière bar positive avec tiroirs cafétéria	92 - 93
Serie / Series / Série		
MCAF	Mueble mesa cafetera Coffe unit / Meuble cafétéria	94
Serie / Series / Série		
ME / MT	Mueble estantería y mesa de trabajo Shelf unit and working table / Meuble étagère et table de travail	95

+Info: www.infrico.com







Serie / Series / Série **800**

EURONORM 600x400







MR 1620 MR 2190 MR 2750 | **MR 1620 BT MR 2190 BT**
REFRIGERACIÓN / REFRIGERATOR / POSITIF | CONGELACIÓN / FREEZER / NÉGATIF

EURONORM 600x400

MR 1620 CR MR 2190 CR MR 2750 CR MR 1620 GR MR 2190 GR MR 2750 GR
REFRIGERACIÓN / REFRIGERATOR / POSITIF

EURONORM 600x400
Pasante/Pass-thru/Traversante

MR 1620 PDC MR 2190 PDC MR 1620 PDCR MR 2190 PDCR MR 1620 EN MR 2190 EN
REFRIGERACIÓN / REFRIGERATOR / POSITIVE

EURONORM 600x400
Ensalada, pizza y pastelería
Salads, pizza & pastry
Salade, pizza et pâtisserie

Serie / Series / Série **EURONORM + GASTRONORM**
Ensalada y pizza
Salad & pizza
Salade et pizza

MEV800



MEV 1000 MEV 1500

Serie / Series / Série **EURONORM 600x400**
Pizza

MPL800 MP800







MPL 1740 MPL 2300 MP 1740 MP 2300 MP 1740 CN MP 2300 CN
REFRIGERACIÓN / REFRIGERATOR / POSITIVE

Serie / Series / Série **FMPP**











FMPP1500 II FMPP2000 II FMPP2500 II FMPP1500 CR FMPP2000 CR FMPP2500 CR FMPP1500 GR FMPP2000 GR FMPP2500 GR
REFRIGERACIÓN / REFRIGERATOR / POSITIVE

Serie / Series / Série **MCAF**





















MCAF 820 MCAF 1000 CD MCAF 1000 CI MCAF 1500 MCAF 2000 MCAF 2500
MESA CAFETERA / COFFE UNIT / MEUBLE CAFÉTÉRIA

Serie / Series / Série **ME / MT**

ME 30/1000 ME 30/1500 ME 30/2000 ME 30/2500 | **ME 60/1000 ME 60/1500 ME 60/2000 ME 60/2500**
MUEBLE ESTANTERÍA / SHELF UNIT / MEUBLE ÉTAGÈRE | MESA DE TRABAJO / WORKING TABLE / TABLE DE TRAVAIL







MT 60/1000 MT 60/1500 MT 60/2000 MT 70/1000 MT 70/1500 MT 70/2000
MESA DE TRABAJO / WORKING TABLE / TABLE DE TRAVAIL

Los datos técnicos están sujetos a posibles variaciones que serán actualizadas periódicamente en las fichas técnicas del producto, disponibles en la web /
The technical data are subject to possible variations that will be updated periodically in the technical data sheets of the product, which are available on the website /
Les données techniques peuvent varier et seront actualisées dans les fiches techniques du produit, disponibles sur le site web.





Mesa de refrigeración y congelación / Undercounter refrigerator and freezer / Desserte dessus de comptoir positive et négative

MODELO MODELE MODÈLE						
	BMPP 1500 II	BMPP 2000 II	BMPP 2500 II	BMPP 1500 BT	BMPP 2000 BT	BMPP 2500 BT
Precio Price Prix						
Medidas Measures [mm] Mesures	1468 x 600 x 850 mm.	1960 x 600 x 850 mm.	2452 x 600 x 850 mm.	1468 x 600 x 850 mm.	1960 x 600 x 850 mm.	2452 x 600 x 850 mm.
Temperatura Temperature Température	-2°C/+8°C			-18°C		
Clase Climática Climatic class Classe climatique	5 / 40° C			4 / 38°C		
Tensión/Frecuencia Electrical data Tension électrique	230V/1ph/50Hz					
Controlador Controller Régulateur	Digital IP65					
Material Material [EXT/INT] Matériel	AISI 304					
Espesor Thickness Épaisseur	70					
Aislamiento Isolation Isolation	40kg/m ³ / Free CFC's / Zero ODP-GWP					
Capacidad Capacity Capacité	250	385	510	250	385	510
Puertas Doors Portes	2	3	4	2	3	4
Nº parrillas / Guías Nº shelves / Slides Nº de grilles / Glissière	2/2 [325x430]	3/3 [325x430]	4/4 [325x430]	2/2 [325x430]	3/3 [325x430]	4/4 [325x430]
Sistema de frío Cooling System Système de froid	Monoblock ventilado / Forced air monoblock / Monoblock ventilé					
Desescarche Defrost Dégivrage	Parada compresor / Compressor off / Arrêt du compresseur			Gas caliente / Hot gas / Gaz chaud		
Expansión Expansion Expansion	Capilar / Capillary / Capillaire			Válvula termostática / Expansion valve / Détendeur thermostatique		
Potencia Power Puissance	260	260	446	443	472	561
Potencia frig. Cooling capacity Puissance Frig.	370	370	690	445	445	540
Consumo Consumption Consommation	1,55	1,80	2,05	4,02	6,57	6,78
Clase energética Energy class Classe Énerg.	A			C	D	C
Refrigerante Refrigerant Gaz	R-290					
Opcional Optional Options	Parrilla / Wire shelf / Grille AN 500 [502X07] Cerradura / Lock / Serrure [506X209; 506X210] Juego de guías / Slides / Jeu de Glissières [GUIACO115430, GUIACO215430] Grupo lado contrario / Group opposite side / Groupe opposé [L]			115V/1ph/60Hz Ruedas / Casters / Roulettes [705X16=2; 705X17=2] Sin peto trasero / Without backsplash / Sans dossieret		230V/1ph/60Hz
	Kit cajones / Drawer Kit / Kit tiroirs BM 1/2 x 200 [JCAJ17BM1/2] BM 1/3 x 100 [JCAJ17BM1/3] BM 2/3 + BM 1/3 [JCAJ17BM2/3]					

Serie / Series / Série **600**

+Info: www.infrico.com



Internet of things

Opcional: Manejo control digital por WiFi o Bluetooth*

Optional: Operating digital control by WiFi or Bluetooth*

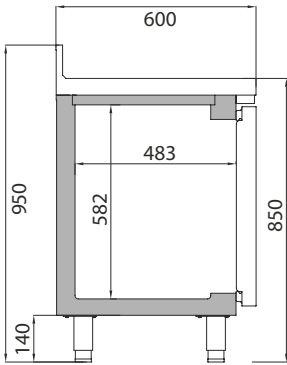

Controlador digital IP 65.
Digital control IP65
Contrôleur digital IP 65.



BMPP 1500 BT



Circulación optimizada del aire
Optimal air flow
Circulation d'air optimisée



Sistema de ventilación de condensación frontal
Front breathing condensation system
Système de ventilation à condensation frontale

BMPP 2000 II

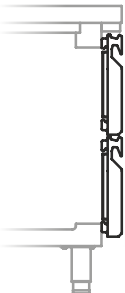
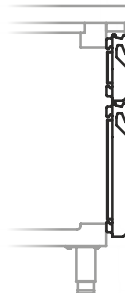
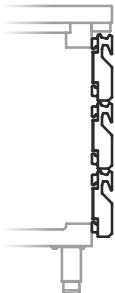

<p>Kit 2 cajones 2 drawers kit Kit 2 tiroirs</p> <p>BM 1/2 x 200</p> 	<p>Kit 2 cajones 2 drawers kit Kit 2 tiroirs</p> <p>BM 2/3x300 + BM 1/3x100</p> 	<p>Kit 3 cajones 3 drawers kit Kit 3 tiroirs</p> <p>BM 1/3x100</p> 
---	--	---

1/2 2/3 1/3
302 x 418 x 205 302 x 418 x 307 302 x 418 x 105









KIT CAJONES / DRAWERS KIT / KIT TIROIRS (MOD. II)

Los datos técnicos están sujetos a posibles variaciones que serán actualizadas periódicamente en las fichas técnicas del producto, disponibles en la web /
The technical data are subject to possible variations that will be updated periodically in the technical data sheets of the product, which are available on the website /
Les données techniques peuvent varier et seront actualisées dans les fiches techniques du produit, disponibles sur le site web.

Mesa refrigerada pre-instalada /
Remote undercounter refrigerator /
Desserte dessus de comptoir groupe à distance

Mesa refrigerada ensaladas /
Salad prep refrigerator undercounter /
Desserte dessus de comptoir posit. prép. salades

MODELO MODELE MODÈLE					Ensaladas / Salad prep / Prép. salades  	
	BMPP 1500 GR	BMPP 2000 GR	BMPP 1500 GRBT	BMPP 2000 GRBT	BMPP 1500 EN	BMPP 2000 EN
Precio Price Prix						
Medidas Measures [mm] Mesures	1240 x 600 x 850 mm.	1732 x 600 x 850 mm.	1240 x 600 x 850 mm.	1732 x 600 x 850 mm.	1468 x 600 x 1100 mm.	1960 x 600 x 1100 mm.
Temperatura Temperature Température	0°C/+6°C		-18°C		0°C/+6°C	
Clase Climática Climatic class Classe climatique			-		4 / 38°C	
Tensión/Frecuencia Electrical data Tension électrique	230V/1ph/50Hz					
Controlador Controller Régulateur	Digital IP65					
Material Material [EXT/INT] Matériel	AISI 304					
Espesor Thickness Épaisseur	70					
Aislamiento Isolation Isolation	40kg/m ³ / Free CFC's / Zero ODP-GWP					
Capacidad Capacity Capacité	250	385	250	385	250+50	385+70
Puertas Doors Portes	2	3	2	3	2	3
N° parrillas / Guías N° shelves / Slides N° de grilles / Glissière	2/2 [325x430]	3/3 [325x430]	2/2 [325x430]	3/3 [325x430]	2/2 [325x430]	3/3 [325x430]
Sistema de frío Cooling System Système de froid	Monoblock ventilado / Forced air monoblock / Monoblock ventilé					
Desescarche Defrost Dégivrage	Parada compresor / Compressor off / Arrêt du compresseur		Gas caliente / Hot gas / Gaz chaud		Parada compresor / Compressor off / Arrêt du compresseur	
Expansión Expansion Expansion	Opcional / Optional / Options				Capilar / Capillary / Capillaire	
Potencia Power Puissance			-		249	249
Potencia frig. Cooling capacity Puissance Frig.	Recom. 370	Recom. 370	Recom. 445	Recom. 445	370	370
Consumo Consumption Consommation	-					
Clase energética Energy class Classe Énerg.	-					
Refrigerante Refrigerant Gaz	-				R-290	
Opcional Optional Options	Juego de guías / Slides / Jeu de Glissières [GUIAC0115430, GUIAC0215430] Cerradura / Lock / Serrure [506X209; 506X210] Parrilla / Wire shelf / Grille [502X07] 115V/1ph/60Hz 230V/1ph/60Hz					
	Válvula expansión [especificar refrig.] / Expansion valve [specify refrig.] / Détendeur [spécifier le gaz] Puerta de cristal [unidad] / Glass door [unit] / Porte vitrée [unité] [PUE17IDGN-PUE17IIGN][GR]				Ruedas / Casters / Roulettes [705X16=2; 705X17=2] BMPP 1500 EN [501X16] = 8 BMPP 2000 EN [501X16] = 11	
	Kit cajones / Drawer Kit / Kit tiroirs BM 1/2 x 200 [JCAJ17BM1/2] BM 1/3 x 100 [JCAJ17BM1/3] BM 2/3 + BM 1/3 [JCAJ17BM2/3]		Kit cajones / Drawer Kit / Kit tiroirs Bajo consultar / On request / À la demande		Kit cajones / Drawer Kit / Kit tiroirs BM 1/2 x 200 [JCAJ17BM1/2] BM 1/3 x 100 [JCAJ17BM1/3] BM 2/3 + BM 1/3 [JCAJ17BM2/3]	

Serie / Series / Série **600**

+Info: www.infrico.com

Posibilidad de acceso frontal y lateral para una mejor manipulación.
 Front and lateral access for better handling
 Possibilité d'accès frontal et latéral pour une meilleure manipulation.

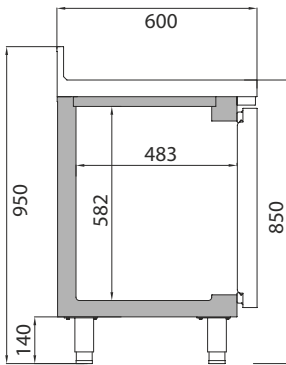

Video del producto
 Product Video
 Vidéo du produit



Infrico Youtube

BMPP 1500 GR

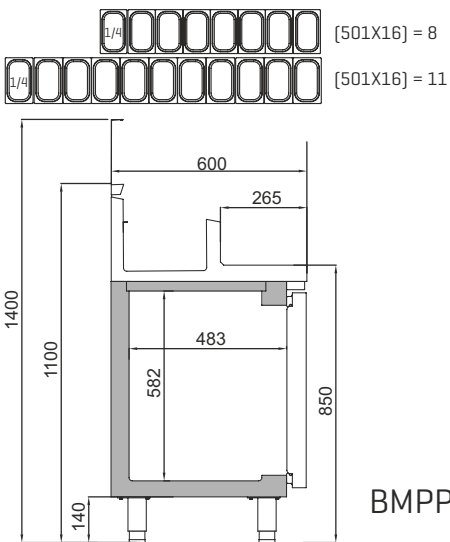

BMPP 2000 EN

Refrigeración estática en la cuba
 Static cooling in the tank
 Refroidissement statique supérieur



Kit 2 cajones
 2 drawers kit
 Kit 2 tiroirs

BM 1/2 x 200

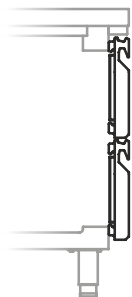

Kit 2 cajones
 2 drawers kit
 Kit 2 tiroirs

BM 2/3x300 +
 BM 1/3x100

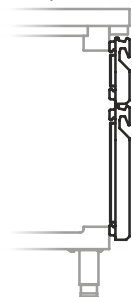

Kit 3 cajones
 3 drawers kit
 Kit 3 tiroirs

BM 1/3x100









1/2 2/3 1/3
302 x 418 x 205 302 x 418 x 307 302 x 418 x 105



KIT CAJONES / DRAWERS KIT / KIT TIROIRS [MOD. GR - EN]

Los datos técnicos están sujetos a posibles variaciones que serán actualizadas periódicamente en las fichas técnicas del producto, disponibles en la web /
 The technical data are subject to possible variations that will be updated periodically in the technical data sheets of the product, which are available on the website /
 Les données techniques peuvent varier et seront actualisées dans les fiches techniques du produit, disponibles sur le site web.

Mesa refrigeración y congelación / Undercounter refrigerator and freezer / Desserte gastronomique positive et négative

MODELO MODELE MODÈLE						
	BMGN 1470 II	BMGN 1960 II	BMGN 2450 II	BMGN 1470 BT	BMGN 1960 BT	BMGN 2450 BT
Precio Price Prix						
Medidas Measures [mm] Mesures	1468 x 700 x 850 mm.	1960 x 700 x 850 mm.	2452 x 700 x 850 mm.	1468 x 700 x 850 mm.	1960 x 700 x 850 mm.	2452 x 700 x 850 mm.
Temperatura Temperature Température	-2°C/+8°C			-18°C		
Clase Climática Climatic class Classe climatique	5 / 40°C			4 / 38°C		
Tensión/Frecuencia Electrical data Tension électrique	230V/1ph/50Hz					
Controlador Controller Régulateur	Digital IP65					
Material Material [EXT/INT] Matériel	AISI 304					
Espesor Thickness Épaisseur	70					
Aislamiento Isolation Isolation	40kg/m ³ / Free CFC's / Zero ODP-GWP					
Capacidad Capacity Capacité	305	465	630	305	465	630
Puertas Doors Portes	2	3	4	2	3	4
Nº parrillas / Guías Nº shelves / Slides Nº de grilles / Glissière	2/10 {325x530}	3/15 {325x530}	4/20 {325x530}	2/10 {325x530}	3/15 {325x530}	4/20 {325x530}
Sistema de frío Cooling System Système de froid	Monoblock ventilado / Forced air monoblock / Monoblock ventilé					
Desescarche Defrost Dégivrage	Parada compresor / Compressor off / Arrêt du compresseur			Gas caliente / Hot gas defrost / Gaz chaud		
Expansión Expansion Expansion	Capilar / Capillary / Capillaire			Válvula de expansión termostática / Thermostatic expansion valve / Détendeur thermostatique		
Potencia Power Puissance	210	368		508	597	711
Potencia frig. Cooling capacity Puissance Frig.	570	690		445	540	640
Consumo Consumption Consommation	1,50	1,95	2,25	5,45	7,71	9,03
Clase energética Energy class Classe Énerg.	A			C	D	D
Refrigerante Refrigerant Gaz	R-290					
Opcional Optional Options	Sin peto trasero / Without backsplash / Sans dosseret			115V/1ph/60Hz		
	Parrilla / Wire shelf / Grille [502X12]			230V/1ph/60Hz		
	Juego de guías / Slides / Jeu de Glissières [GUIAC0115530, GUIAC0215530]			Ruedas / Casters / Roulettes [705X16=2; 705X17=2]		
	Cerradura / Lock / Serrure [506X209; 506X210]					
	Grupo lado contrario / Group opposite side / Groupe opposé [L]					
	Kit cajones / Drawer Kit / Kit tiroirs BMGN 1/2 x 200 [JCAJ17GN1/2] BMGN 1/3 x 100 [JCAJ17GN1/3] BMGN 2/3 + BMGN 1/3 [JCAJ17GN2/3]					

Serie / Series / Série **GN1/1 700**

+Info: www.infrico.com

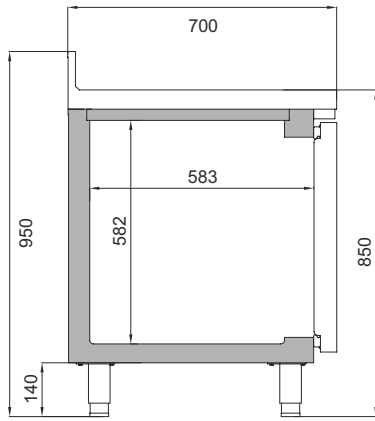

BMGN 1470 II



BMGN 1470 BT

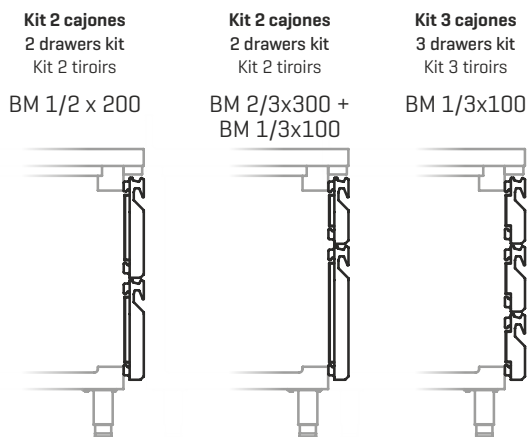

Kit 2 cajones
2 drawers kit
Kit 2 tiroirs
BM 1/2 x 200

Kit 2 cajones
2 drawers kit
Kit 2 tiroirs
BM 2/3x300 +
BM 1/3x100

Kit 3 cajones
3 drawers kit
Kit 3 tiroirs
BM 1/3x100

1/2 **2/3** **1/3**
302 x 518 x 205 **302 x 518 x 307** **302 x 518 x 105**



KIT CAJONES / DRAWERS KIT / KIT TIROIRS [MOD. II]

Mesa refrigerada pre-instalada / Remote undercounter refrigerator / Desserte dessus de comptoir groupe á distance

Mesa refrigerada central puertas a dos caras / Pass thru undercounter refrigerator / Desserte gastronomique positive traversante

MODELO MODELE MODÈLE	BMGN 1470 GR	BMGN 1960 GR	BMGN 2450 GR	BMGN 1470 GRBT	BMGN 1960 GRBT	BMGN 2450 GRBT	Dos caras / Pass-thru / Traversante	
							BMGN 1470 PDC	BMGN 1960 PDC
Precio Price Prix								
Medidas Measures [mm] Mesures	1240 x 700 x 850 mm.	1732 x 700 x 850 mm.	2224 x 700 x 850 mm.	1240 x 700 x 850 mm.	1732 x 700 x 850 mm.	2224 x 700 x 850 mm.	1468 x 700 x 850 mm.	1960 x 700 x 850 mm.
Temperatura Temperature Température	-2°C/+8°C			-18°C			-2°C/+8°C	
Clase Climática Climatic class Classe climatique	-			-			5 / 40°C	
Tensión/Frecuencia Electrical data Tension électrique	230V/1ph/50Hz							
Controlador Controller Régulateur	Digital IP65							
Material Material [EXT/INT] Matériel	Inox AISI 304							
Espesor Thickness Épaisseur	70							
Aislamiento Isolation Isolation	40kg/m ³ / Free CFC's / Zero ODP-GWP							
Capacidad Capacity Capacité	305	465	630	305	465	630	290	440
Puertas Doors Portes	2	3	4	2	3	4	4	6
Nº parrillas / Guías Nº shelves / Slides Nº de grilles / Glissière	2/10 (325x530)	3/15 (325x530)	4/20 (325x530)	2/10 (325x530)	3/15 (325x530)	4/20 (325x530)	2/10 (325x530)	3/15 (325x530)
Sistema de frío Cooling System Système de froid	-						Monoblock ventilado / Forced air monoblock / Monoblock ventilé	
Desescarche Defrost Dégivrage	Parada compresor / Compressor off / Arrêt du compresseur			Gas caliente / Hot gas / Gaz chaud			Parada compresor / Compressor off / Arrêt du compresseur	
Expansión Expansion Expansion	-						Capilar / Capillary / Capillaire	
Potencia Power Puissance	-			-			210	368
Potencia frig. Cooling capacity Puissance Frig.	343	690	690	445	540	640	370	690
Consumo Consumption Consommation	-			-			1,50	1,95
Clase energética Energy class Classe Énerg.	-			-			A	A
Refrigerante Refrigerant Gaz	-						R-290	
Opcional Optional Options	Puerta de cristal / Glass door / Porte vitrée [PUE17IDGN-PUE17IIGN] Cerradura / Lock / Serrure [506X209; 506X210] Parrilla / Wire shelf / Grille [502X12]			115V/1ph/60Hz 230V/1ph/60Hz				
	Kit cajones / Drawer Kit / Kit tiroirs BMGN 1/2 x 200 [JCAJ17GN1/2] BMGN 1/3 x 100 [JCAJ17GN1/3] BMGN 2/3 + BMGN 1/3 [JCAJ17GN2/3]			Kit cajones / Drawer Kit / Kit tiroirs Bajo consultar / On request / À la demande			Juego de guías / Slides / Jeu de Glissières [GUIAC03505]	
	Válvula de expansión (especificar refrigerante) Expansion valve [specify refrigerant] Détendeur d'expansion [spécifier le gaz souhaité] Juego de guías / Slides / Jeu de Glissières [GUIAC0115530, GUIAC0215530]						Parrilla inoxidable / Stainless steel wire shelf / Grille Inox [502X46]	

Serie / Series / Série **GN1/1 700**

+Info: www.infrico.com

Possibilidad de acceso frontal y lateral para una mejor manipulación
 Front and lateral access for better handling
 Possibilité d'accès frontal et latéral pour une meilleure manipulation.

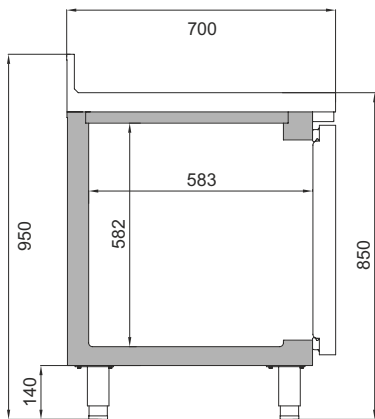

BMGN 1960 GR

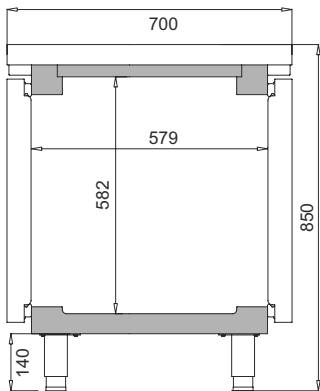

Pasante/Pass-thru/Traversante
 BMGN 1470 PDC



Kit 2 cajones
 2 drawers kit
 Kit 2 tiroirs

BM 1/2 x 200

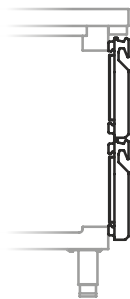

Kit 2 cajones
 2 drawers kit
 Kit 2 tiroirs

BM 2/3x300 +
 BM 1/3x100

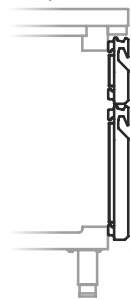

Kit 3 cajones
 3 drawers kit
 Kit 3 tiroirs

BM 1/3x100

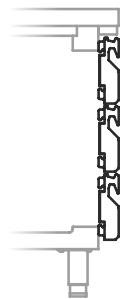

1/2
 302 x 518 x 205

2/3
 302 x 518 x 307

1/3
 302 x 518 x 105







KIT CAJONES / DRAWERS KIT / KIT TIROIRS [MOD. GR]

Los datos técnicos están sujetos a posibles variaciones que serán actualizadas periódicamente en las fichas técnicas del producto, disponibles en la web /
 The technical data are subject to possible variations that will be updated periodically in the technical data sheets of the product, which are available on the website /
 Les données techniques peuvent varier et seront actualisées dans les fiches techniques du produit, disponibles sur le site web.

Mesa refrigeración y congelación Euronorma 600x400 pastelería / Euronorm 600x400 refrigerator and freezer counter / Tour pâtissier positif et négatif Euronorme 600x400

EURONORM 600x400

MODELO MODELE MODÈLE					
	MR 1620	MR 2190	MR 2750	MR 1620 BT	MR 2190 BT
Precio Price Prix					
Medidas Measures [mm] Mesures	1618 x 800 x 850 mm.	2185 x 800 x 850 mm.	2752 x 800 x 850 mm.	1618 x 800 x 850 mm.	2185 x 800 x 850 mm.
Temperatura Temperature Température	-2°C/+8°C			-18°C	
Clase Climática Climatic class Classe climatique	5 / 40°C			4 / 38°C	
Tensión/Frecuencia Electrical data Tension électrique	230V/1ph/50Hz				
Controlador Controller Régulateur	Digital IP65				
Material Material [EXT/INT] Matériel	Inox AISI 304				
Espesor Thickness Épaisseur	70				
Aislamiento Isolation Isolation	40kg/m ³ / Free CFC's / Zero ODP-GWP				
Capacidad Capacity Capacité	420	635	850	420	635
Puertas Doors Portes	2	3	4	2	3
Nº parrillas / Guías Nº shelves / Slides Nº de grilles / Glissière	2/10 [600x400]	3/15 [600x400]	4/20 [600x400]	2/10 [600x400]	3/15 [600x400]
Sistema de frío Cooling System Système de froid	Monoblock ventilado / Forced air monoblock / Monoblock ventilé				
Desescarche Defrost Dégivrage	Parada compresor / Compressor off / Arrêt du compresseur			Gas caliente / Hot gas defrost / Gaz chaud	
Expansión Expansion Expansion	Capilar / Capillary / Capillaire			Válvula de expansión termostática / Thermostatic expansion valve / Détendeur thermostatique	
Potencia Power Puissance		368		568	712
Potencia frig. Cooling capacity Puissance Frig.		690		540	639
Consumo Consumption Consommation	1,67	2,07	3,06	6,03	11,15
Clase energética Energy class Classe Énerg.	A		B	C	D
Refrigerante Refrigerant Gaz	R-290				
Opcional Optional Options	Granito / Granite-top / Granit MR1620 [1618X800X30] [606X35] Granito / Granite-top / Granit MR2190 [2185X800X30] [606X36] Granito / Granite-top / Granit MR2750 [2752X800X30] [606X37] Bandeja Inox/ Stainless Steel Tray / Bac Inox 600x400 [A850P41] Cerradura / Lock / Serrure [506X209; 506X210]			Parrilla / Wire shelf / Grille [502X26] Juego de guías / Slides / Jeu de Glissières [GUIAL0115630, GUIAL0215630] Ruedas / Casters / Roulettes [705X16=2; 705X17=2] 115V/1ph/60Hz 230V/1ph/60Hz	

Serie / Series / Série **800**

+Info: www.infrico.com

	<p>Opcional: Manejo control digital por WiFi o Bluetooth</p>	<p>Optional: Operating digital control by WiFi or Bluetooth</p>
--	--	---

Frio Ventilado con efecto estático para pastelería profesional
 Ventilated cooling with static effect for professional patisseries
 Refroidissement ventilé avec effet statique pour les pâtisseries professionnelles



MR 1620

Opcional
 Optional
 Option

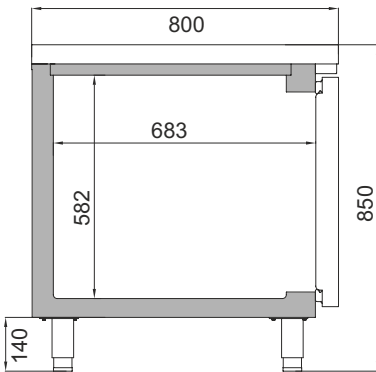

MR 2190 BT



Opcional granito
 Optional granite worktop
 Option granite



MR 2750



Los datos técnicos están sujetos a posibles variaciones que serán actualizadas periódicamente en las fichas técnicas del producto, disponibles en la web /
 The technical data are subject to possible variations that will be updated periodically in the technical data sheets of the product, which are available on the website /
 Les données techniques peuvent varier et seront actualisées dans les fiches techniques du produit, disponibles sur le site web.



MESAS DE REFRIGERACIÓN Y DE CONGELACIÓN

FRÍO - BARRA Y COCINA - MESAS FRÍAS - SERIE 600 - SERIE 700



Termostato electrónico



Encimera con cantos curvados



Pies metálicos regulables



Detalle interior puertas



MPS 200 / MNS 200

MPS / MNS / MPG / MNG

Mesas frías Snack y Gastronorm GN1/1, de refrigeración y de mantenimiento de congelados, con 2, 3 y 4 puertas ciegas con tirador incorporado y estantes de varilla plastificada.

- Encimera, estructura y exterior de acero inox. con acabado satinado.
- Encimera de cantos redondeados con peto trasero de 100mm.
- Bisagras con retorno automático y fijación de puerta.
- Control electrónico de temperatura.
- Evaporador de tiro forzado con recubrimiento anti-corrosión.
- Evaporación automática del agua del desescarche.
- Aislamiento de poliuretano inyectado, libre de CFC, con una densidad de 40 kg/m³.
- Estantes interiores desmontables y de altura regulable.
- Pies de acero regulables en altura.
- **Dotación: 1 parrilla con guías por puerta.**

ACCESORIOS

- Parrillas y soportes para mesas Snack (525x405 / 460x405 mm).
- Parrillas y soportes para mesas GN1/1 (325x530 mm).
- Kit 4 ruedas.
- Cerradura.

OPCIONES

- Mesas refrigeradas con encimera con fregadero.
- Mesas refrigeradas con cajones.
- Mesas refrigeradas con puertas de cristal.
- Mesas refrigeradas frente-mostrador (1045mm alto).
- Mesas centrales refrigeradas con puertas pasantes.
- Grupo refrigerador a la izquierda.
- Sin encimera.

MESAS DE REFRIGERACIÓN Y DE CONGELACIÓN

FRÍO - BARRA Y COCINA - MESAS FRÍAS - SERIE 600 - SERIE 700

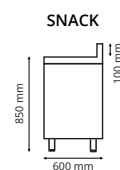
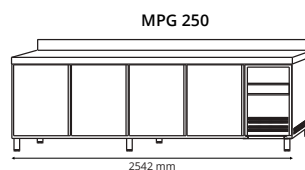
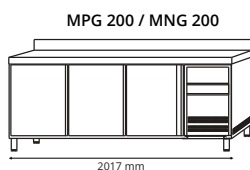
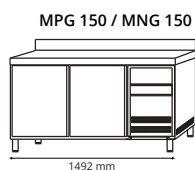

SNACK / FONDO 600

	FRÍO			CONGELACIÓN	
	MPS 150	MPS 200	MPS 250	MNS 150	MNS 200
	1492x600x850 mm	2017x600x850 mm	2542x600x850 mm	1492x600x850 mm	2017x600x850 mm
	250 L	390 L	530 L	250 L	390 L
	2	3	4	2	3
	VENTILADO	VENTILADO	VENTILADO	VENTILADO	VENTILADO
	-2°C/+8°C	-2°C/+8°C	-2°C/+8°C	-20°C/-18°C	-20°C/-18°C
	R290	R290	R290	R290	R290
	220V-1N-50Hz	220V-1N-50Hz	220V-1N-50Hz	220V-1N-50Hz	220V-1N-50Hz
	220 W	220 W	350 W	670 W	680 W
	1019 kWh/año	1119 kWh/año	1919 kWh/año	2212 kWh/año	2467 kWh/año
	98 kg	125 kg	152 kg	98 kg	125 kg

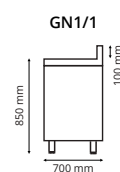
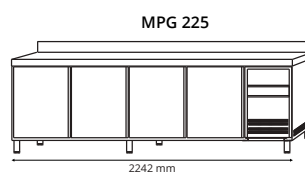
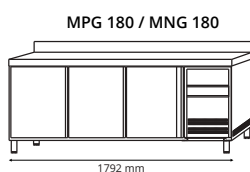
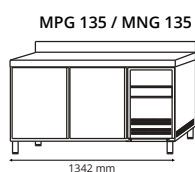

GASTRONORM GN1/1 / FONDO 700

	FRÍO			CONGELACIÓN	
	MPG 135	MPG 180	MPG 225	MNG 135	MNG 180
	1342x700x850 mm	1792x700x850 mm	2242x700x850 mm	1342x700x850 mm	1792x700x850 mm
	290 L	455 L	615 L	290 L	455 L
	2	3	4	2	3
	VENTILADO	VENTILADO	VENTILADO	VENTILADO	VENTILADO
	-2°C/+8°C	-2°C/+8°C	-2°C/+8°C	-20°C/-18°C	-20°C/-18°C
	R290	R290	R290	R290	R290
	220V-1N-50Hz	220V-1N-50Hz	220V-1N-50Hz	220V-1N-50Hz	220V-1N-50Hz
	220 W	220 W	350 W	670 W	680 W
	1018 kWh/año	1119 kWh/año	1919 kWh/año	2212 kWh/año	2467 kWh/año
	112 kg	139 kg	166 kg	112 kg	139 kg

BAJOMOSTRADORES BT

CARACTERÍSTICAS TÉCNICAS

Fondo 70 cms.

Modelo		BM70 BT 2P	BM70 BT 3P	BM70 BT 4P
Ancho	mm	1.420	1.870	2.320
Fondo	mm	700	700	700
Alto	mm	850	850	850
Alto modelos SP	mm	800	800	800
Alto modelos AL	mm	950	950	950
Alto con pies	mm	920	920	920
Alto modelos SP con pies	mm	870	870	870
Alto modelos AL con pies	mm	1.020	1.020	1.020
Capacidad	Lts	310	460	620
Dotación (estantes GN 1/1 + kit guías)	Nº /puerta	1x2	1x3	1x4
Refrigeración	Tipo	ventilada	ventilada	ventilada
Descarce	Tipo	automático	automático	automático
Temperatura	ºC	-18 / -22	-18 / -22	-18 / -22
Alimentación	Ph/Volts/Hz	2 x 230 / 50	2 x 230 / 50	2 x 230 / 50
Potencia total	kW	0,65	0,7	0,73
P.V.P.	€	3.330	3.687	4.211
P.V.P. Mod. AL*	€	3.503	4.190	4.639
P.V.P. Mod. SP*	€	3.261	3.889	4.299

* SP = Sin encimera / AL = Con encimera y con peto sanitario de 100 mm

Accesorios	P.V.P. €
Kit guías "L" estante GN (GLTGN)	26
Estante rejilla plastificada GN 1/1 (GRPLTGN)	31
Estante plano perforado GN 1/1 (PFTGN)	54



Mod. BM 70 BT 2P AL

BAJOMOSTRADOR BT 70:

La línea BM70BT, son bajos mostradores refrigerados fabricados con componentes y materiales de la máxima calidad. Adaptables a cualquier ambiente y exigencia. Ofrecen máxima personalización y eficiencia. Puede elegir entre modelos, sin encimera "SP", con encimera y peto sanitario "AL", o con encimera sin peto sanitario. Totalmente configurables, en un mismo mueble se pueden combinar puertas y kit de cajones.

- Interior y exterior en acero inoxidable, excepto trasera externa en acero galvanizado.
- Ángulos interiores redondeadas.
- Puertas con autocierre.
- Pies regulables en altura (110-190) mm.
- Aislamiento de 60mm de espesor. Poliuretano de alta presión inyectado sin gas CFC. Bajo impacto ambiental.
- Panel de control electrónico con visualizador.
- Unidad frigorífica monobloc tropicalizada y extraíble.
- Acceso desde el frontal, al condensador y a los componentes técnicos, para facilitar el mantenimiento y limpieza.
- **BM70BT**: (700mm de profundidad). Equipado de serie con 1 rejilla plastificada GN 1/1 y 1 kit de guías por puerta.
- Todos los modelos se suministran de serie con el grupo frigorífico situado en el lado derecho. Para muebles con grupo a la izquierda consultar precios.



Mod.: Estandar con encimera sin peto sanitario.



Mod.: SP sin encimera.



Mod.: AL con encimera y peto sanitario de 100 mm.

BAJOMOSTRADORES BT

CARACTERÍSTICAS TÉCNICAS

Fondo 70 cms.

Modelo		BM70 BT 2P	BM70 BT 3P	BM70 BT 4P
Ancho	mm	1.420	1.870	2.320
Fondo	mm	700	700	700
Alto	mm	850	850	850
Alto modelos SP	mm	800	800	800
Alto modelos AL	mm	950	950	950
Alto con pies	mm	920	920	920
Alto modelos SP con pies	mm	870	870	870
Alto modelos AL con pies	mm	1.020	1.020	1.020
Capacidad	Lts	310	460	620
Dotación (estantes GN 1/1 + kit guías)	Nº /puerta	1x2	1x3	1x4
Refrigeración	Tipo	ventilada	ventilada	ventilada
Descarce	Tipo	automático	automático	automático
Temperatura	ºC	-18 / -22	-18 / -22	-18 / -22
Alimentación	Ph/Volts/Hz	2 x 230 / 50	2 x 230 / 50	2 x 230 / 50
Potencia total	kW	0,65	0,7	0,73
P.V.P.	€	3.330	3.687	4.211
P.V.P. Mod. AL*	€	3.503	4.190	4.639
P.V.P. Mod. SP*	€	3.261	3.889	4.299

* SP = Sin encimera / AL = Con encimera y con peto sanitario de 100 mm

Accesorios	P.V.P. €
Kit guías "L" estante GN (GLTGN)	26
Estante rejilla plastificada GN 1/1 (GRPLTGN)	31
Estante plano perforado GN 1/1 (PFTGN)	54



Mod. BM 70 BT 2P AL

BAJOMOSTRADOR BT 70:

La línea BM70BT, son bajos mostradores refrigerados fabricados con componentes y materiales de la máxima calidad. Adaptables a cualquier ambiente y exigencia. Ofrecen máxima personalización y eficiencia. Puede elegir entre modelos, sin encimera "SP", con encimera y peto sanitario "AL", o con encimera sin peto sanitario. Totalmente configurables, en un mismo mueble se pueden combinar puertas y kit de cajones.

- Interior y exterior en acero inoxidable, excepto trasera externa en acero galvanizado.
- Ángulos interiores redondeadas.
- Puertas con autocierre.
- Pies regulables en altura (110-190) mm.
- Aislamiento de 60mm de espesor. Poliuretano de alta presión inyectado sin gas CFC. Bajo impacto ambiental.
- Panel de control electrónico con visualizador.
- Unidad frigorífica monobloc tropicalizada y extraíble.
- Acceso desde el frontal, al condensador y a los componentes técnicos, para facilitar el mantenimiento y limpieza.
- **BM70BT**: (700mm de profundidad). Equipado de serie con 1 rejilla plastificada GN 1/1 y 1 kit de guías por puerta.
- Todos los modelos se suministran de serie con el grupo frigorífico situado en el lado derecho. Para muebles con grupo a la izquierda consultar precios.



Mod.: Estandar con encimera sin peto sanitario.



Mod.: SP sin encimera.



Mod.: AL con encimera y peto sanitario de 100 mm.

FREGADERO ADICIONAL OPCIONAL
 OPTIONAL ADDITIONAL SINK
 ÉVIER SUPPLÉMENTAIRE EN OPTION

GN
1/1

FONDO
700

BANDEJA Y PARRILLA DE TRABAJO OPCIONALES
 OPTIONAL TRAY AND WORK RACK
 PLATEAU ET RACK DE TRAVAIL EN OPTION

170€

CERRADURA PUERTA OPCIONAL
 OPTIONAL DOOR LOCK
 SERRURE DE PORTE EN OPTION



BJ22-70



BJ13-70



BJ18-70



BJ22-70



BJ27-70

BAJOMOSTRADORES FONDO 700

REFRIGERACIÓN POSITIVA

REFRIGERACIÓN NEGATIVA

DIMENSIONES	CAPACIDAD	ESTANTES	VOLTAJE		RANGO	POTENCIA FRIG. W	CONSUMO	PVP		RANGO	POTENCIA FRIG. W	CONSUMO	PVP
1345x700x850	255 LT	2 REGULABLES	230V-50HZ	BJ13-70	-2°C / +8°C	502 W	235 W	2.590 €	BJ13-70-N	-20°C / -15°C	606 W	535 W	3.390 €
1795x700x850	399 LT	3 REGULABLES	230V-50HZ	BJ18-70	-2°C / +8°C	502 W	240 W	3.070 €	BJ18-70-N	-20°C / -15°C	606 W	550 W	3.980 €
2245x700x850	543 LT	4 REGULABLES	230V-50HZ	BJ22-70	-2°C / +8°C	845 W	340 W	3.640 €					
2695x700x850	686 LT	4 REGULABLES	230V-50HZ	BJ27-70	-2°C / +8°C	845 W	360 W	4.100 €					

OPCIONAL : 4 RUEDAS = 98€ // 6 RUEDAS = 145€
 OPTIONAL : 4 WHEELS = 98€ // 6 WHEELS = 145€
 EN OPTION : 4 ROUES = 98€ // 6 ROUES = 145€

PROFESIONAL

BAJOMOSTRADORES
FONDO 700



Si este documento no incluye las marcas o productos que fabrica o distribuye tu empresa, notifícanoslo en contacto@hosteleria10.com.

Estaremos encantados de incorporarlas.