



Catálogo de los  
**PARASOLES**  
distribuidos en España

Este catálogo agrupa toda la información disponible sobre los [Parasoles](#) que se distribuyen en España, según la facilitan sus respectivos fabricantes. Esta información incluye productos, modelos, características técnicas y precios.

Los precios indicados en este catálogo son los Precios de Venta Recomendados por cada fabricante, que puede haberlos actualizado, dejándolos obsoletos. Consúltanos el precio actual.

En todo caso, en la tienda online Hostelería10.com mejoramos con grandes descuentos los precios de todos los productos incluidos en este catálogo.

Las marcas de la sección Parasoles que forman parte de este catálogo son:

Conva

Muebles Romero

Ezpeleta

Ripay

Garbar

Sólo una cuidada selección de los mejores productos de este catálogo están incluidos en Hostelería10.com.

Si tienes alguna duda respecto a alguno de estos productos o no encuentras el que buscas, escríbenos a [contacto@hosteleria10.com](mailto:contacto@hosteleria10.com) o llámanos al 91 161 03 04.

Estaremos encantados de atenderle.

# PARASOLES



Ref.  
**819**  
Línea FORTE

## PARASOL Playa Ø1,8m.

Parasol de acero inoxidable ideal para playas.

Stainless steel sunshade ideal for beaches.

Parasol en acier inoxydable idéal pour les plages.

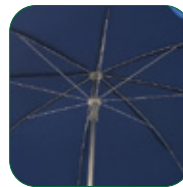

Montura de acero inox con varillas de acero zincado.

Stainless steel frame with zincked steel ribs.

Chassis en acier inox avec baleines en acier zingué.

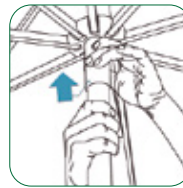

Sistema push up.

Push up system.

Système push-up.

**Montura disponible en:**  
Available structure in:  
Structure disponible en:

Inox

**SOPORTE ADICIONAL NO INCLUIDO**  
ADDITIONAL SUPPORT NOT INCLUDED  
SUPPORT ADDITIONNEL NON INCLUS



819TP



819PIN

**819TP**  
Pincho de acero inox. 99 cm.  
Stainless steel lower pole 99 cm.  
Tube inférieur en acier inoxydable 99 cm.

**819PIN**  
Ángulo de acero zincado 120 cm.  
Angle steel picket 120 cm.  
Cornière en acier zingué 120 cm.

**TEJIDOS DISPONIBLES**  
AVAILABLE FABRICS  
TISSUS DISPONIBLES

**Acrylic**  
Basic  
Masa Soft

**Polyester**

**Olefin**

**BASES COMPATIBLES\***  
COMPATIBLE BASES\*  
PIED ADAPTABLES\*

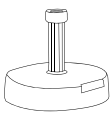

HS20

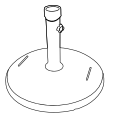

TH22

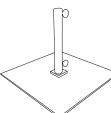

MP20

**MÁSTIL**  
POLE  
MÂT

Inox Ø 23mm

**OPCIONAL / OPTIONAL / OPTIONNEL**



**Personalización mediante serigrafía o vinilo**  
Personalization by screen printing or vinyl  
Personnalisation par sérigraphie ou vinyle

**VARILLAS**  
RIBS  
BALEINES

8 uds. zincadas Ø 4,6 mm  
8 galvanized Ø 4,6 mm  
8 unités galvanisées Ø 4,6 mm

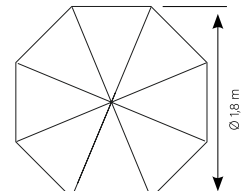

\* Elección de las bases en función de las condiciones del lugar de la instalación y bajo responsabilidad del cliente. / \* Choice of bases depending on the conditions of the place of installation and under the responsibility of the client. / \* Choix des bases en fonction des conditions du lieu de l'installation et sous la responsabilité du client.

## PARASOLES

Parasol reforzado para instalaciones urbanas con espacios reducidos.

Reinforced sunshade for urban installations in small spaces.

Parasol renforcé pour les installations urbaines avec peu d'espace.



## PARASOL Urban

**CU815**  
Línea FORTE

**155x155**

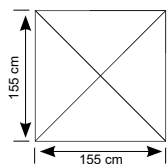

**RE815**  
Línea FORTE

**180x130**

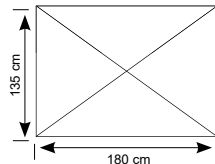

Montura disponible en:

Available structure in:

Structure disponible en:



Antracita

TEJIDOS DISPONIBLES  
AVAILABLE FABRICS  
TISSUS DISPONIBLES

**Acrylic**  
Basic  
Masa Soft

**Polyester**

**Olefin**

BASES COMPATIBLES\*  
COMPATIBLE BASES\*  
PIED ADAPTABLES\*



HS20

TH22

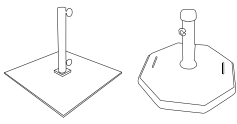

MP20

TH30

OPCIONAL / OPTIONAL / OPTIONNEL



Faldón

Flap  
Lambrequin



Personalización mediante serigrafía o vinilo

Personalization by screen printing or vinyl  
Personnalisation par sérigraphie ou vinyle

MÁSTIL  
POLE  
MÂT

Acero / Steel / Acier  
Ø33/Ø36 mm.

VARILLAS  
RIBS  
BALEINES

4 uds. paragon acero galvanizado Ø 8 mm  
4 pcs. galvanized steel paragon Ø 8 mm  
4 pcs. parapluie en acier galvanisé Ø 8 mm



Mástil de acero galvanizado con 4 varillas paragon.

Galvanized steel pole with 4 paragon steel ribs.

Mât acier galvanisé avec 4 baleines paragon.



Cable de refuerzo.  
Reinforcement wire.  
Cable renforcé.



Terminal en PVC  
PVC terminal  
Chateau boule PVC



Sistema de apertura  
Opening system  
Système d'ouverture

\* Elección de las bases en función de las condiciones del lugar de la instalación y bajo responsabilidad del cliente. / \* Choice of bases depending on the conditions of the place of installation and under the responsibility of the client. / \* Choix des bases en fonction des conditions du lieu de l'installation et sous la responsabilité du client.

# PARASOLES

Ref.  
**821**  
Línea BASIC

# PARASOL Feria Ø2m.

Parasol de aluminio inclinable con varillas de acero.

Tilting aluminum sunshade with steel rods.

Parasol inclinable avec mât aluminium et baleines acier zingué.



Estructura de aluminio con varillas de acero

Aluminum structure with steel rods

Mât aluminium et baleines acier zingué

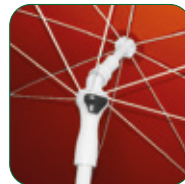

Inclinable.

With tilt.

Inclinable

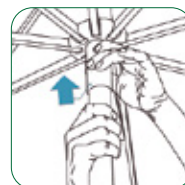

Sistema push up.

Push up system.

Système push-up.

### TEJIDOS DISPONIBLES AVAILABLE FABRICS TISSUS DISPONIBLES

**Acrylic**  
Basic  
Masa Soft

**Polyester**

**Olefin**

### BASES COMPATIBLES\* COMPATIBLE BASES\* PIED ADAPTABLES\*

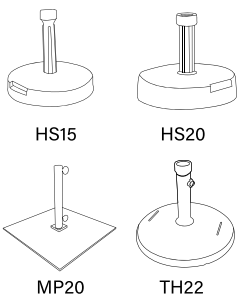

### MÁSTIL POLE MÂT

Aluminio / Aluminium /  
Aluminium  
Ø 29 / Ø 32 mm.

### VARILLAS RIBS BALEINES

8 uds. acero / stell / acier

### OPCIONAL / OPTIONAL / OPTIONNEL



#### Personalización mediante serigrafía o vinilo

Personalization by screen printing or vinyl  
Personnalisation par sérigraphie ou vinyle

#### Montura disponible en:

Available structure in:  
Structure disponible en:



Blanco

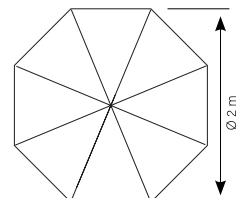

\* Elección de las bases en función de las condiciones del lugar de la instalación y bajo responsabilidad del cliente. / \* Choice of bases depending on the conditions of the place of installation and under the responsibility of the client. / \* Choix des bases en fonction des conditions du lieu de l'installation et sous la responsabilité du client.



Ref.  
**833**  
Línea FORTE

## PARASOL Aquatex Ø2m.

Parasol reforzado en aluminio estriado con tejido textilene. Para instalaciones como hoteles, playas, piscinas, etc. Fácil limpieza.

Reinforced aluminum sunshade with textilene fabric. For installations such as hotels, beaches, swimming pools, etc. Easy cleaning.

Parasol renforcé en aluminium avec tissu en textilène. Pour les installations telles que les hôtels, les plages, les piscines, etc. Nettoyage facile.



Varillas de fibra de vidrio.  
Fiberglass ribs.  
Baleines en fibre de verre.

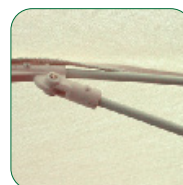

Bisagras de PVC.  
PVC hinges.  
Charnières PVC.

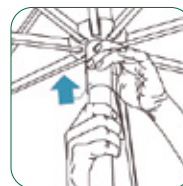

Sistema push up.  
Push up system.  
Système push-up.

### TEJIDOS DISPONIBLES AVAILABLE FABRICS TISSUS DISPONIBLES

**Textilene**

### BASES COMPATIBLES\* COMPATIBLE BASES\* PIED ADAPTABLES\*

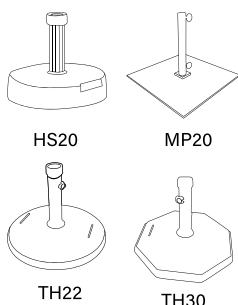

### MÁSTIL POLE MÂT

Aluminio / Aluminium / Aluminium  
Ø35 / Ø40 mm.

### VARILLAS RIBS BALEINES

10 uds. de Ø8 mm en fibra de vidrio.  
10 pcs. of Ø8 mm in fiberglass.  
10 pcs de Ø8 mm en fibre de verre.

### Montura disponible en:

Available structure in:  
Structure disponible en:



Blanco

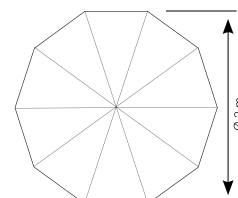

\* Elección de las bases en función de las condiciones del lugar de la instalación y bajo responsabilidad del cliente. / \* Choice of bases depending on the conditions of the place of installation and under the responsibility of the client. / \* Choix des bases en fonction des conditions du lieu de l'installation et sous la responsabilité du client.

# PARASOLES



Ref. **839**  
Línea FORTE

## PARASOL Aqua Ø2m.

**Parasol reforzado en aluminio estriado. Ideal para instalaciones.**

Reinforced aluminum striated sunshade. Ideal for installations.

*Parasol renforcé en aluminium avec mât strié. Idéal pour toute installation.*



**Varillas de fibra de vidrio.**  
Fiberglass ribs.  
Baleines en fibre de verre.

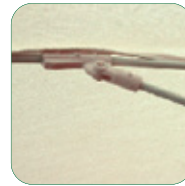

**Bisagras de PVC.**  
PVC hinges.  
Charnières PVC.



**Capitos de PVC.**  
PVC rib end tip.  
Capuchons PVC.

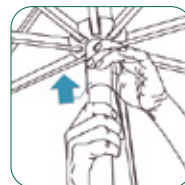

**Sistema push up.**  
Push up system.  
Système push-up.

**Montura disponible en:**

Available structure in:  
Structure disponible en:



Blanco

**TEJIDOS DISPONIBLES**  
AVAILABLE FABRICS  
TISSUS DISPONIBLES

**Acrylic**  
Basic  
Masa Soft

**Polyester**

**Olefin**

**BASES COMPATIBLES\***  
COMPATIBLE BASES\*  
PIED ADAPTABLES\*

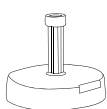

HS20

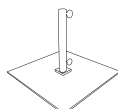

MP20

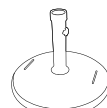

TH22



TH30

**MÁSTIL**  
POLE  
MÂT

Aluminio / Aluminium /  
Aluminium  
Ø35 / Ø40 mm.

**VARILLAS**  
RIBS  
BALEINES

10 uds. de 6,35 mm en fibra de vidrio.  
10 pcs. of Ø6,4 mm in fiberglass.  
10 pcs de Ø6,4 mm en fibre de verre.

**OPCIONAL / OPTIONAL / OPTIONNEL**



**Personalización mediante serigrafía o vinilo.**  
Personalization by screen printing or vinyl.  
Personnalisation par sérigraphie ou vinyle.

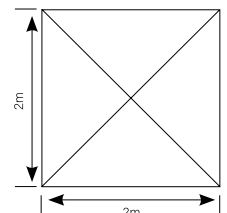

\* Elección de las bases en función de las condiciones del lugar de la instalación y bajo responsabilidad del cliente. / \* Choice of bases depending on the conditions of the place of installation and under the responsibility of the client. / \* Choix des bases en fonction des conditions du lieu de l'installation et sous la responsabilité du client.



Ref. **888**  
Línea BASIC  
**PARASOL**  
**Arena**

Parasol con líneas rectas que facilita la creación de espacios uniformes.

Parasol with straight lines that facilitates the creation of uniform spaces.

Parasol aux lignes droites qui facilite la création d'espaces uniformes.

**888**  
**Arena 2x2**

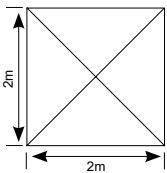

Ajustable a 3 alturas.

3 height adjust.

3 réglages de hauteur.



Bisagras de PVC.

PVC hinges.

Charnières PVC.



Mástil ocultable

Concealable pole

Mât coulissant

**892**  
**Arena Ø2,5m.**

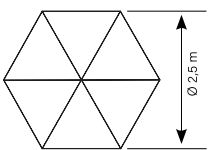

Inclinable  
With tilt  
Inclinable



Montura disponible en:

Available structure in:

Structure disponible en:



Blanco

TEJIDOS DISPONIBLES  
AVAILABLE FABRICS  
TISSUS DISPONIBLES

**Acrylic**  
Basic  
Masa Soft

**Polyester**

**Olefin**

BASES COMPATIBLES\*  
COMPATIBLE BASES\*  
PIED ADAPTABLES\*

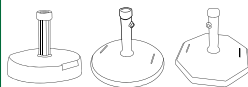

HS20 TH22 TH30

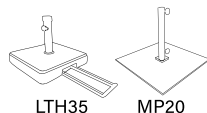

LTH35 MP20

OPCIONAL / OPTIONAL / OPTIONNEL



Faldón  
Flap  
Lambrequin



Personalización mediante serigrafía o vinilo

Personalization by screen printing or vinyl

Personnalisation par sérigraphie ou vinyle

MÁSTIL  
POLE  
MÂT

Aluminio Ø38/Ø35 mm.  
Aluminium Ø38/Ø35 mm.  
Aluminium Ø38/Ø35mm

VARILLAS  
RIBS  
BALEINES

4 uds (888) o 6 uds (892) aluminio 14x20 mm.  
4 pcs (888) or 6 pcs (892) aluminum 14x20 mm.  
4 uds (888) ou 6 pcs (892) aluminium 14x20 mm.

\* Elección de las bases en función de las condiciones del lugar de la instalación y bajo responsabilidad del cliente. / \* Choice of bases depending on the conditions of the place of installation and under the responsibility of the client. / \* Choix des bases en fonction des conditions du lieu de l'installation et sous la responsabilité du client.



# PARASOLES



Ref.  
**875**  
Línea FORTE

## PARASOL Via 2x2

Parasol reforzado con varillas redondas de aluminio.

Parasol reinforced with round aluminum rods.

Parasol renforcé avec des baleines rondes en aluminium.

1 Pieza / Pole / Mât

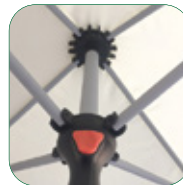

Sistema push up.

Push up system.

Système push-up.



Acabados ABS.

ABS finishes.

Pièces d'union en abs



Acabado punta varilla

Rod end finish

Fixation toile extrémité baleine

Montura disponible en:

Available structure in:

Structure disponible en:



Gris plata

OPCIONAL / OPTIONAL / OPTIONNEL



Faldón

Flap

Lambrequin



Personalización mediante serigrafía o vinilo

Personalization by screen printing or vinyl

Personnalisation par sérigraphie ou vinyle

TEJIDOS DISPONIBLES

AVAILABLE FABRICS  
TISSUS DISPONIBLES

**Acrylic**  
Basic  
Masa Soft

**Polyester**

**Olefin**

BASES COMPATIBLES\*

COMPATIBLE BASES\*  
PIED ADAPTABLES\*

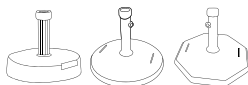

HS20

TH22

TH30



LTH35

MP20

MÁSTIL

POLE  
MÂT

Aluminio Ø38 mm./ pared 1,5 mm.

Aluminium Ø38 mm./ wall thickness 1,5 mm.

Aluminium Ø38 mm./ épaisseur 1,5 mm.

VARILLAS

RIBS  
BALEINES

4 uds. de aluminio Ø19 mm./ pared 1,2 mm.

4 pcs aluminium Ø19 mm./ wall thickness 1,2 mm.

4 pcs aluminium Ø19 mm./ épaisseur 1,2 mm.

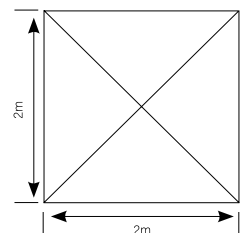

\* Elección de las bases en función de las condiciones del lugar de la instalación y bajo responsabilidad del cliente. / \* Choice of bases depending on the conditions of the place of installation and under the responsibility of the client. / \* Choix des bases en fonction des conditions du lieu de l'installation et sous la responsabilité du client.



Ref.  
**897**  
Línea BASIC

## PARASOL Patio 2,5x2,5

Parasol de medida muy versátil adaptable a todos los espacios.

Parasol of very versatile size adaptable to all spaces.

Parasol d'une taille très polyvalente, adaptable à tous les espaces.



Sistema de apertura con doble polea y bloqueo de seguridad con pasador.

Double pulley system with safety pin lock.  
Système de poulie double, avec goupille de sécurité.



Freno de la cuerda.

Rope brake.  
Frein à câble.



Bisagras de PVC.

PVC hinges.  
Charnières de PVC.

### Montura disponible en:

Available structure in:  
Structure disponible en:



Blanco

### OPCIONAL / OPTIONAL / OPTIONNEL



Faldón  
Flap  
Lambrequin



Personalización mediante serigrafía o vinilo  
Personalization by screen printing or vinyl  
Personnalisation par sérigraphie ou vinyle

### TEJIDOS DISPONIBLES AVAILABLE FABRICS TISSUS DISPONIBLES

**Acrylic**  
Basic  
Masa Soft

**Polyester**

**Olefin**

### BASES COMPATIBLES\* COMPATIBLE BASES\* PIED ADAPTABLES\*



TH30

TH137

LTH35

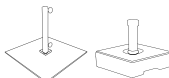

MP40

HS40

### MÁSTIL POLE MÂT

Aluminio Ø48 mm./ pared 1 mm.  
Aluminium Ø48 mm./ wall thickness 1 mm.  
Aluminium Ø48 mm./ épaisseur 1 mm.

### VARILLAS RIBS BALEINES

8 uds. de aluminio 14x20 (x0,5) mm. Salida de vientos.  
8 pcs aluminium 14x20 (x0,5) mm. Wind exhaust.  
8 pcs aluminium 14x20 (x0,5) mm. Soufflet anti-vent.

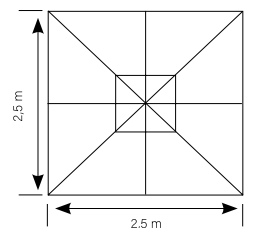

\* Elección de las bases en función de las condiciones del lugar de la instalación y bajo responsabilidad del cliente. / \* Choice of bases depending on the conditions of the place of installation and under the responsibility of the client. / \* Choix des bases en fonction des conditions du lieu de l'installation et sous la responsabilité du client.

## PARASOLES

Ref.  
**885**  
Línea BASIC

# PARASOL Zoco 2x3

Parasol ideal para ciudad y adaptable a terrazas.

Parasol ideal for city and adaptable to terraces.

Parasol idéal pour la ville et adaptable aux terrasses.



Sistema de apertura por polea y bloqueo de seguridad con pasador.

Pulley system with safety pin lock.

Système de poulie, avec goupille de sécurité.

### Montura disponible en:

Available structure in:

Structure disponible en:



Blanco

### OPCIONAL / OPTIONAL / OPTIONNEL



#### Faldón

Flap  
Lambrequin



#### Personalización mediante serigrafía o vinilo

Personalization by screen printing or vinyl  
Personnalisation par sérigraphie ou vinyle

### TEJIDOS DISPONIBLES

AVAIBLE FABRICS  
TISSUS DISPONIBLES

**Acrylic**  
Basic  
Masa Soft

**Polyester**

**Olefin**

### BASES COMPATIBLES\*

COMPATIBLE BASES\*  
PIED ADAPTABLES\*

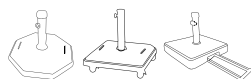

TH30

TH137

LTH35

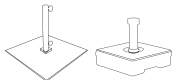

MP40

HS40

### MÁSTIL

POLE  
MÂT

Aluminio Ø48 mm./ pared 1,2 mm.

Aluminium Ø48 mm./ wall thickness 1,2 mm.

Aluminium Ø48 mm./ épaisseur 1,2 mm.

### VARILLAS

RIBS  
BALEINES

8 uds. de aluminio 12x18 mm. Salida de vientos.

8 pcs aluminium 12x18 mm. Wind exhaust.

8 pcs aluminium 12x18 mm. Soufflet anti-vent.

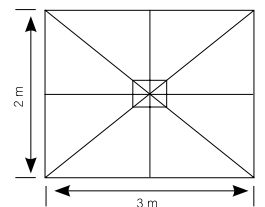

\* Elección de las bases en función de las condiciones del lugar de la instalación y bajo responsabilidad del cliente. / \* Choice of bases depending on the conditions of the place of installation and under the responsibility of the client. / \* Choix des bases en fonction des conditions du lieu de l'installation et sous la responsabilité du client.

Ref.  
**886**  
Línea BASIC

# PARASOL Ruedo Ø3m.

Parasol para crear espacios individuales.

Parasol to create individual spaces.

Parasol pour créer des espaces individuels.



Sistema de apertura por polea y bloqueo de seguridad con pasador.

Pulley system with safety pin lock.  
Système de poulie, avec goupille de sécurité.



Bloqueo de la cuerda de la polea.

Rope brake.  
Frein à câble.

Montura disponible en:

Available structure in:  
Structure disponible en:



Blanco



Ref. F/XR-PL02

Funda disponible.  
Cover available.  
Housse de protection disponible.

OPCIONAL / OPTIONAL / OPTIONNEL



Faldón  
Flap  
Lambrequin



Personalización mediante serigrafía o vinilo  
Personalization by screen printing or vinyl  
Personnalisation par sérigraphie ou vinyle

TEJIDOS DISPONIBLES  
AVAILABLE FABRICS  
TISSUS DISPONIBLES

**Acrylic**  
Basic  
Masa Soft

**Polyester**

**Olefin**

BASES COMPATIBLES\*  
COMPATIBLE BASES\*  
PIED ADAPTABLES\*

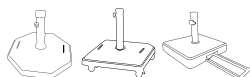

TH30 TH137 LTH35

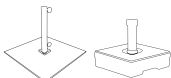

MP40 HS40

MÁSTIL  
POLE  
MÂT

Aluminio Ø48 mm./ pared 1,2 mm.

Aluminium Ø48 mm./ wall thickness 1,2 mm.

Aluminium Ø48 mm./ épaisseur 1,2 mm.

VARILLAS  
RIBS  
BALEINES

8 uds. de aluminio 12x19 mm. Salida de vientos.

8 pcs aluminium 12x19 mm. Wind exhaust.

8 pcs aluminium 12x19 mm. Soufflet anti-vent.

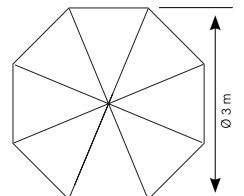

\* Elección de las bases en función de las condiciones del lugar de la instalación y bajo responsabilidad del cliente. / \* Choice of bases depending on the conditions of the place of installation and under the responsibility of the client. / \* Choix des bases en fonction des conditions du lieu de l'installation et sous la responsabilité du client.

# PARASOLES



Ref.  
**898**  
Línea BASIC

## PARASOL **Plaza 3x3**

Parasol de aluminio de líneas rectas, manejable y ligero.

Aluminum parasol of straight lines, handy and light.

*Parasol en aluminium aux lignes droites, facile à manipuler et léger.*



**Sistema de apertura por polea y bloqueo de seguridad con pasador.**

Pulley system with safety pin lock.

Système de poulie, avec goupille de sécurité.



**Bisagras de PVC.**

PVC hinges.

Charnières de PVC.



**Freno de la cuerda.**

Rope brake.

Frein à câble.

### Montura disponible en:

Available structure in:

Structure disponible en:



Blanco



### Ref. F/XR-PL02

Funda disponible.

Cover available.

Housse de protection disponible.

### OPCIONAL / OPTIONAL / OPTIONNEL



**Faldón**

Flap

Lambrequin



**Personalización mediante serigrafía o vinilo**

Personalization by screen printing or vinyl

Personnalisation par sérigraphie ou vinyle

### TEJIDOS DISPONIBLES

AVAILABLE FABRICS  
TISSUS DISPONIBLES

**Acrylic**  
Basic  
Masa Soft

**Polyester**

**Olefin**

### BASES COMPATIBLES\*

COMPATIBLE BASES\*  
PIED ADAPTABLES\*

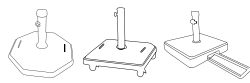

TH30

TH137

LTH35

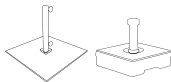

MP40

HS40

### MÁSTIL

POLE  
MÂT

Aluminio Ø48 mm./ pared 1,2 mm.

Aluminium Ø48 mm./ wall thickness 1,2 mm.

Aluminium Ø48 mm./ épaisseur 1,2 mm.

### VARILLAS

RIBS  
BALEINES

8 uds. de aluminio 12x19 mm. Salida de vientos.

8 pcs aluminium 12x19 mm. Wind exhaust.

8 pcs aluminium 12x19 mm. Soufflet anti-vent.

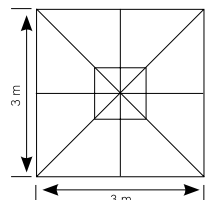

\* Elección de las bases en función de las condiciones del lugar de la instalación y bajo responsabilidad del cliente. / \* Choice of bases depending on the conditions of the place of installation and under the responsibility of the client. / \* Choix des bases en fonction des conditions du lieu de l'installation et sous la responsabilité du client.

# Instalaciones

INSTALLATIONS

PARASOLES



Los precios pueden estar desactualizados. Llámanos al 91 161 03 04 para consultar los precios en vigor.

PARASOL

# Heavy Duty

Parasol reforzado con amortiguación de viento en puntas de varilla, alto rendimiento y elegancia.

Reinforced sunshade with wind dampening on rod ends, high performance and elegance.

*Parasol renforcé et élégant.*



Ref. **876**  
Línea FORTE

PARASOL  
**Ø3m.**

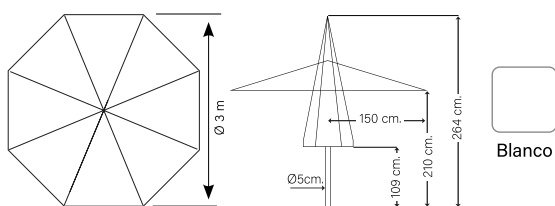

Blanco

Ref. **887**  
Línea FORTE

PARASOL  
**2x3m**

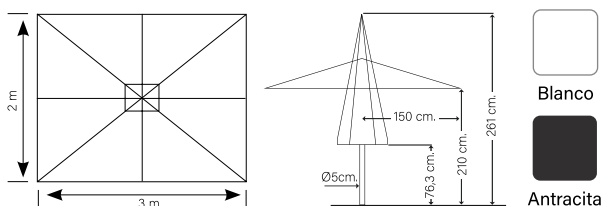

Blanco

Antracita

Ref. **899**  
Línea FORTE

PARASOL  
**3x3m**

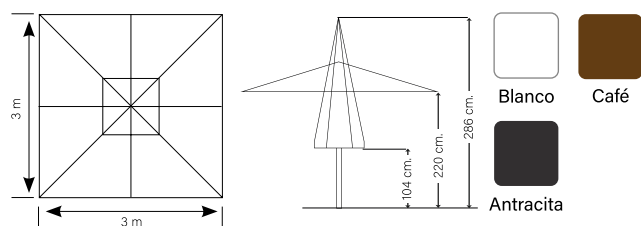

Blanco

Café

Antracita

Ref. **895**  
Línea FORTE

PARASOL **NOVEDAD**  
**3.5x3.5m**

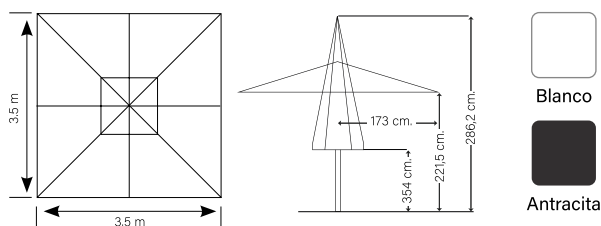

Blanco

Antracita

\* Elección de las bases en función de las condiciones del lugar de la instalación y bajo responsabilidad del cliente. / \* Choice of bases depending on the conditions of the place of installation and under the responsibility of the client. / \* Choix des bases en fonction des conditions du lieu de l'installation et sous la responsabilité du client.



Unión de varilla reforzada.  
Reinforced rib hinges.  
Charnières renforcées.



Freno de la cuerda.  
Rope brake.  
Frein à câble.



Puntas de tensión auto-ajustables.  
Autoadjustable end tip, due to fabric stress.  
Extrémité des baleines autoajustables



Sistema de doble polea y bloqueo con pasador de seguridad.  
Double pulley system and safety pin lock.  
Système de poulie double avec goupille de sécurité.

OPCIONAL / OPTIONAL / OPTIONNEL



**Faldón**  
Flap  
Lambrequin



**Personalización mediante serigrafía o vinilo**  
Personalization by screen printing or vinyl  
Personnalisation par sérigraphie ou vinyle

**Montura disponible según modelo:**

Frame available according to model:

Couleurs disponibles selon le modèle:



Blanco



Café



Antracita

**TEJIDOS DISPONIBLES**  
AVAILABLE FABRICS  
TISSUS DISPONIBLES

**Acrylic**  
Basic  
Masa Soft  
Masa Forte

**Polyester**

**Olefin**  
250

**BASES COMPATIBLES\***  
COMPATIBLE BASES\*  
PIED ADAPTABLES\*

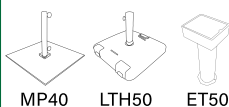

MP40

LTH50

ET50

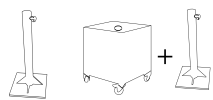

245

CAJÓN+245

**MÁSTIL**  
POLE  
MÂT

Aluminio 1 p. Ø 50 mm.  
Pared/Wall/Épaisseur 1,6mm.

**VARILLAS**  
RIBS  
BALEINES

8 uds. aluminio/aluminium/  
aluminium 20 x 30 mm.

**ACCESORIOS**  
COMPLÉMENTS  
COMPLÉMENTAIRES

- Calefactores / Heating / Radiateurs
- Iluminación / Lighting / Éclairage
- Canal de unión / Junction channel / Canal de liaison

**Ref. F/XR-PC01**

Funda disponible.  
Cover available.  
Housse de protection disponible.



\* Elección de las bases en función de las condiciones del lugar de la instalación y bajo responsabilidad del cliente. / \* Choice of bases depending on the conditions of the place of installation and under the responsibility of the client. / \* Choix des bases en fonction des conditions du lieu de l'installation et sous la responsabilité du client.



# PARASOLES

Parasoles de mástil desplazado para conseguir espacios diafanos con regulación abatible.

Parasol with displaced mast to achieve diaphanous spaces with folding regulation.

Parasols avec mât décentré pour un gai de place.



1 Pieza / Pole / Mât

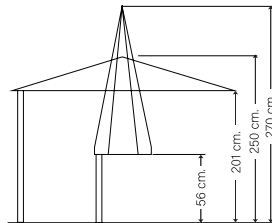

Ref. **878**  
Línea BASIC

## PARASOL Lateral 3x3



Apertura con manivela.  
Inclinación regulable.

Crank to open.  
Inclination regulable.  
Système avec manivelle et  
inclinaison.



Cruzeta incluida, rotación de 360°  
Losas de cemento NO incluidas

Cross included, with 360° rotation.  
Concrete slabs NOT included.

Croix incluse, avec rotation 360°  
Dalles en option

### Montura disponible en:

Available structure in:  
Structure disponible en:



Blanco



### Ref. F/XR-PL02

Funda disponible.  
Cover available.  
Housse de protection disponible.

### OPCIONAL / OPTIONAL / OPTIONNEL



### Personalización mediante serigrafía o vinilo

Personalization by screen printing or vinyl  
Personnalisation par sérigraphie ou vinyle

### TEJIDOS DISPONIBLES AVAILABLE FABRICS TISSUS DISPONIBLES

**Acrylic**  
Basic  
Masa Soft

**Polyester**

**Olefin**

### LOSAS OPCIONALES\* OPTIONAL SLABS\* DALLES OPTIONNELLES\*

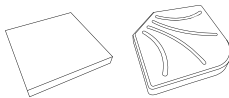

4 losas  
CDLC

4 losas  
DTH25

Fijación directa al suelo  
Direct fixing to the ground  
Fixation directe au sol

### MÁSTIL POLE MÂT

Aluminio Ø65 mm./ pared 1,2 mm.  
Aluminium Ø65 mm./ wall thickness 1,2 mm.  
Aluminium Ø65 mm./ épaisseur 1,2 mm.

### VARILLAS RIBS BALEINES

8 uds. de aluminio 14x20 mm. Salida de vientos.  
8 pcs aluminium 14x20 mm. Wind exhaust.  
8 pcs aluminium 14x20 mm. Soufflet anti-vent.

### ACCESORIOS ADICIONALES ADDITIONAL COMPLEMENTS COMPLÉMENTAIRES SUPPLÉMENTAIRES

- Calefactores / Heating / Chauffages
- Iluminación/ Lighting / Éclairage

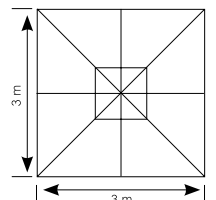

\* Elección de las bases en función de las condiciones del lugar de la instalación y bajo responsabilidad del cliente. / \* Choice of bases depending on the conditions of the place of installation and under the responsibility of the client. / \* Choix des bases en fonction des conditions du lieu de l'installation et sous la responsabilité du client.



Ref.  
**879**  
Línea FORTE

# PARASOL Lateral Plus 3x3



Apertura con manivela.  
Inclinación regulable.

Crank to open.  
Inclination regulable.  
Manivelle pour ouvrir.  
Réglage d'inclinaison.



Cruzeta incluida, rotación de 360°

Cross included, with 360° rotation.  
Croix inclus, avec rotation 360°

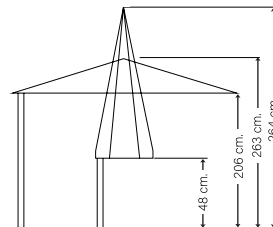

1 Pieza / Pole / Mât

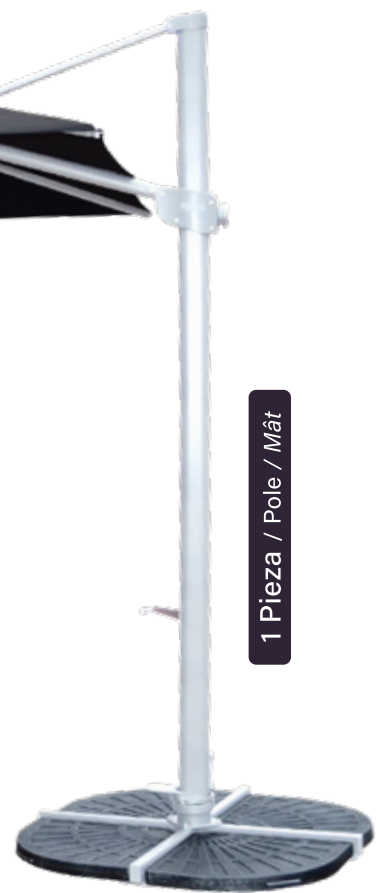

Puntas de tensión auto-ajustables.

Autoadjustable end tip, due to fabric stress.  
Extrémités de baleines auto-ajustables

**Montura disponible en:**

Available structure in:  
Structure disponible en:



Blanco



**Ref. F/XR-PL02**

Funda disponible.  
Cover available.  
Housse de protection disponible.

**OPCIONAL / OPTIONAL / OPTIONNEL**



**Personalización mediante serigrafía o vinilo**

Personalization by screen printing or vinyl  
Personnalisation par sérigraphie ou vinyle

**TEJIDOS DISPONIBLES**  
AVAILABLE FABRICS  
TISSUS DISPONIBLES

**Acrylic**  
Basic  
Masa Soft

**Polyester<sup>PU</sup>**

**Olefin**

**LOSAS OPCIONALES\***  
OPTIONAL SLABS\*  
DALLES OPTIONNELLES\*

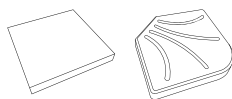

4 losas  
CDLC

4 losas  
DTH25

Fijación directa al suelo  
Direct fixing to the ground  
Fixation directe au sol

**MASTIL**  
POLE  
MÂT

Aluminio 65x80 mm./ pared 1,2 mm.  
Aluminium 65x80 mm./ wall thickness 1,2 mm.  
Aluminium 65x80 mm./ épaisseur 1,2 mm.

**VARILLAS**  
RIBS  
BALEINES

8 uds. de aluminio 14x28 mm. Salida de vientos.  
8 pcs aluminium 14x28 mm. Wind exhaust.  
8 pcs aluminium 14x28 mm. Soufflet anti-vent.

**ACCESORIOS ADICIONALES**  
ADDITIONAL COMPLEMENTS  
COMPLÉMENTAIRES SUPPLÉMENTAIRES

- Calefactores / Heating / Chauffages
- Iluminación/ Lighting / Éclairage

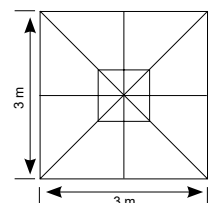

\* Elección de las bases en función de las condiciones del lugar de la instalación y bajo responsabilidad del cliente. / \* Choice of bases depending on the conditions of the place of installation and under the responsibility of the client. / \* Choix des bases en fonction des conditions du lieu de l'installation et sous la responsabilité du client.

# PARASOL Master

Parasol robusto idóneo para instalaciones permanentes.

Robust parasol suitable for permanent installations.

Parasol robuste adapté pour installations fixes.



Ref.  
**889**  
Línea FORTE

## PARASOL Master 3x3

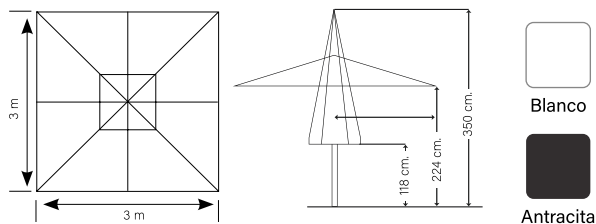

Ref.  
**884**  
Línea FORTE

## PARASOL **NOVEDAD** Master 3x4

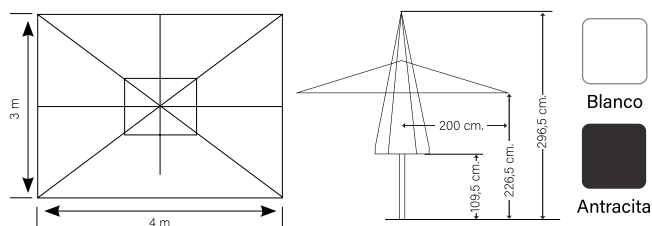

Ref.  
**894**  
Línea FORTE

## PARASOL Master 4x4

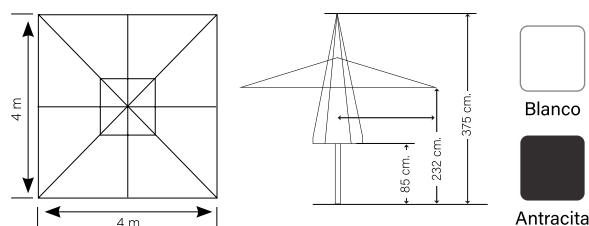



Apertura telescópica / 4 varillas de refuerzo.

Telescopic open system / 4 added ribs.  
Système d'ouverture télescopique / Triples baleines



Punta y enganche reforzados.  
Reinforced rib end tip fabric attachment.  
Fixation renforcée de la toile.

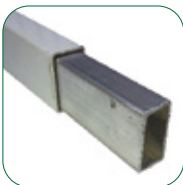

Varilla interior de refuerzo.

Inner reinforcement.  
Baleine intérieure de renort au niveau des unions.



Mástil cuadrado con cantos redondeados. Manivela extraíble.  
Square pole with rounded corners.  
Detachable crank.

Mât carré aux angles arrondis. Manivelle détachable.

Montura disponible según modelo:

Frame available according to model:  
Cadre disponible selon le modèle :



Blanco



Antracita

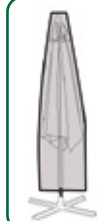

Ref. F/894P30

Funda disponible.  
Cover available.  
Housse de protection disponible.

OPCIONAL / OPTIONAL / OPTIONNEL



Faldón  
Flap  
Lambrequin



Personalización mediante serigrafía o vinilo  
Personalization by screen printing or vinyl  
Personnalisation par sérigraphie ou vinyle

TEJIDOS DISPONIBLES  
AVAILABLE FABRICS  
TISSUS DISPONIBLES

**Acrylic**  
Masa Forte

**Polyester** PU

**Olefin**  
250

BASES COMPATIBLES\*  
COMPATIBLE BASES\*  
PIED ADAPTABLES\*

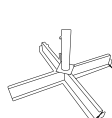

ALBC +  
4 losetas



245-90



ET70



Cajón + 245-90

MASTIL  
POLE  
MÂT

Aluminio 71x71 mm./ pared 3,1 mm.  
Aluminium 71x71 mm./ wall thickness 3,1 mm.  
Aluminium 71x71 mm./ épaisseur 3,1 mm.

VARILLAS  
RIBS  
BALEINES

8 uds. de aluminio 20x35 mm. Salida de vientos.  
8 pcs aluminium 20x35 mm. Wind exhaust.  
8 pcs aluminium 20x35 mm. Soufflet anti-vent.

ACCESORIOS ADICIONALES  
ADDITIONAL COMPLEMENTS  
COMPLEMENTAIRES SUPPLÉMENTAIRES

- Calefactores / Heating / Radiateurs
- Iluminación / Lighting / Éclairage
- Cortinas / Curtains / Rideaus
- Canal vierteaguas / Rain gutter / Gouttière

\* Elección de las bases en función de las condiciones del lugar de la instalación y bajo responsabilidad del cliente. / \* Choice of bases depending on the conditions of the place of installation and under the responsibility of the client. / \* Choix des bases en fonction des conditions du lieu de l'installation et sous la responsabilité du client.

# PARASOL Giant

Parasol gigante con varilla larga con doble refuerzo en tramo de unión.

Long rib double reinforce on junction hinge section.

Parasols de grandes dimensions.



**INCLUIDO / INCLUDES / INCLUANT**

Acople metálico de fijación incluido, con tapa.  
Fixing metal coupling included, with cover cap.  
A utiliser si le sol n' est pas ferme.

**OPCIONAL / OPTIONAL / OPTIONNEL**

Base empotrable con bisagra para fácil colocación del parasol.  
Inground base with hinge to facilitate the parasol installation.  
Pied á fixer nors sol.

1 Pieza / Pole / Mât

Ref. **864** PARASOL  
Línea FORTE **Giant 4x4**

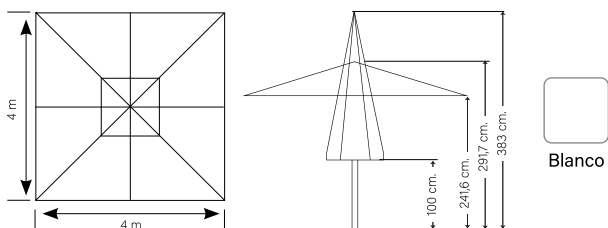

Ref. **865** PARASOL  
Línea FORTE **Giant 5x5**

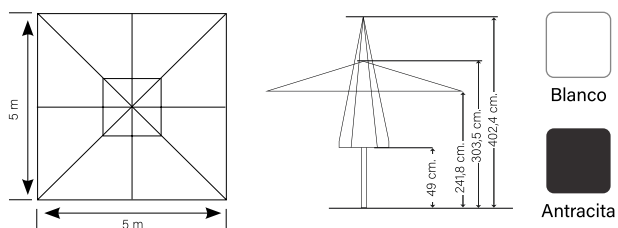

## PARASOLES



**Sistema de apertura telescópico.**  
Telescopic open system.  
Système d'ouverture télescopique.



**Sistema de apertura mediante cremallera metálica.**  
Metallic zip open system.  
Système d'ouverture tigre métallique crantée



**Mástil estriado Ø86 mm. Manivela extraíble.**  
Fluted pole Ø86 mm.  
Detachable crank.  
Mât strié Ø86 mm.  
Manivelle détachable.

### Montura disponible según modelo:

Frame available according to model:

Cadre disponible selon le modèle :



Blanco



Antracita



### Ref. F/865P30

**Funda disponible.**  
Cover available.  
Housse de protection disponible.

### OPCIONAL / OPTIONAL / OPTIONNEL



**Faldón**  
Flap  
Lambrequin



**Personalización mediante serigrafía o vinilo**  
Personalization by screen printing or vinyl  
Personnalisation par sérigraphie ou vinyle

### TEJIDOS DISPONIBLES AVAILABLE FABRICS TISSUS DISPONIBLES

**Acrylic**  
Masa Forte

**Polyester** PU

**Olefin**  
250

### MASTIL POLE MÂT

**Mástil aluminio 86 mm. / pared 3,1 mm.**  
Aluminium pole Ø86 mm. / wall thickness 3,1 mm.  
Mât aluminium blanc Ø86 mm. / épaisseur 3,1 mm.

### VARILLAS RIBS BALEINES

**8 pcs aluminio 20x35 mm. Refuerzo interior.**  
8 pcs aluminium, 20x35 mm. Inner reinforcement.  
8 pcs 20x35 mm. Renfort intérieur.

### ACCESORIOS ADICIONALES ADDITIONAL COMPLEMENTS COMPLÉMENTAIRES SUPPLÉMENTAIRES

- Calefactores / Heating / Radiateurs
- Iluminación / Lighting / Éclairage
- Cortinas / Curtains / Rideaux
- Canal vierteaguas / Rain gutter / Gouttière

\* Elección de las bases en función de las condiciones del lugar de la instalación y bajo responsabilidad del cliente. / \* Choice of bases depending on the conditions of the place of installation and under the responsibility of the client. / \* Choix des bases en fonction des conditions du lieu de l'installation et sous la responsabilité du client.

PARASOL

# Madera plus



Parasoles fabricados con madera de eucalipto grandis.

Parasols made of eucalyptus grandis wood.

Parasols en bois d'eucalyptus grandis.



Ref. **841**  
Línea FORTE

PARASOL  
**Ø2m**

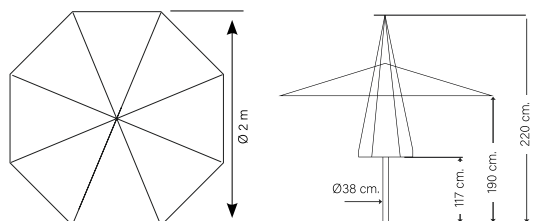

Ref. **842**  
Línea FORTE

PARASOL  
**2x2 m**

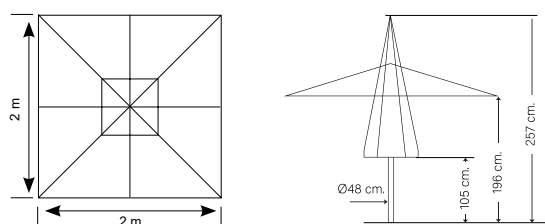

Ref. **843**  
Línea FORTE

PARASOL  
**Ø3m**

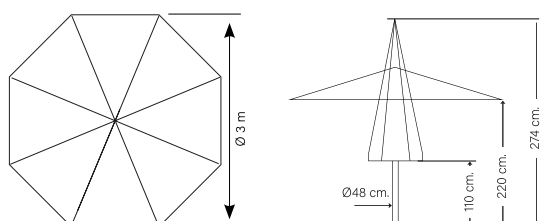

Ref. **844**  
Línea FORTE

PARASOL  
**3x3 m**

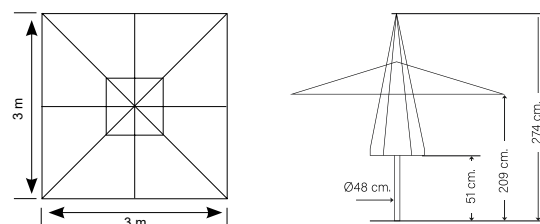

## PARASOLES



### Montura disponible en:

Available structure in:  
Structure disponible en:



### Ref. F/ XR-PC01

Funda disponible.  
Cover available.  
Housse de protection disponible.

### OPCIONAL / OPTIONAL / OPTIONNEL



Faldón  
Flap  
Lambrequin



Personalización mediante  
serigrafía o vinilo  
Personalization by screen printing or vinyl  
Personnalisation par sérigraphie ou vinyle

### TEJIDOS DISPONIBLES AVAILABLE FABRICS TISSUS DISPONIBLES

**Acrylic**  
Basic  
Masa Soft

**Polyester**

**Olefin**

### BASES COMPATIBLES\* COMPATIBLE BASES\* PIED ADAPTABLES\*



Ref	VARILLAS RIBS BALEINES	PESO WEIGHT POIDS	MÁSTIL POLE MÂT
841	8 varillas de 17x22 mm	8,5 kg.	Ø38 mm.
843	8 varillas de 20x28 mm	11,8 kg.	Ø48 mm.
842	8 varillas de 20x28 mm	12,6 kg.	Ø48 mm.
844	8 varillas de 20x28 mm	14,5 kg.	Ø48 mm.

\* Elección de las bases en función de las condiciones del lugar de la instalación y bajo responsabilidad del cliente. / \* Choice of bases depending on the conditions of the place of installation and under the responsibility of the client. / \* Choix des bases en fonction des conditions du lieu de l'installation et sous la responsabilité du client.



## PARASOLES



### PARASOL

## Serigrafías y vinilos

SERIGRAPHY AND VINYL/ SÉRIGRAPHIE ET VINYLE

Estampación y faldones opcionales en todos los modelos.

Print and flap as an option in all models.

*Possibilité de personnaliser les parasols.*



### PARASOL

## Cerramientos

PARASOL ENCLOSURES / RIDEAU POUR PARASOL

Cortina universal para parasoles, con una medida estándar en 2,3,4 y 5m de ancho. Acabado de doble perfil de aluminio, superior e inferior con faldón.

Universal curtain for sunshades, with a standard size in 2,3,4 and 5m wide. Finished with double aluminum profile, upper and lower with skirt.

*Rideau, avec longueurs standard de 2, 3, 4 et 5m. Finition avec un double profil en aluminium, supérieur et inférieur avec bavette.*

#### TEJIDOS DISPONIBLES

AVAILABLE FABRICS  
TISSUS DISPONIBLES

- PVC transparente combinado con PVC color
- PVC transparente combinado con Acrylic Masa Forte
- Crystal PVC combined with colored PVC
- Transparent PVC combined with Acrylic Masa Forte
- Fenêtre PVC transparent combiné avec PVC couleur
- Fenêtre PVC transparent combiné avec Acrylic Masa Forte



Alta transparencia  
High transparency  
Haute transparence



Consultar medidas especiales  
Consult special sizes  
Tailles spéciales sur demande





# Canales vierteaguas

RAIN GUTTER / GOUTTIÈRE

Canal de unión para la evacuación de agua.

Joint channel for water evacuation.

*Gouttiere d'union parasol.*



Consultar medidas especiales

Consult special sizes

Autres dimensions consulter

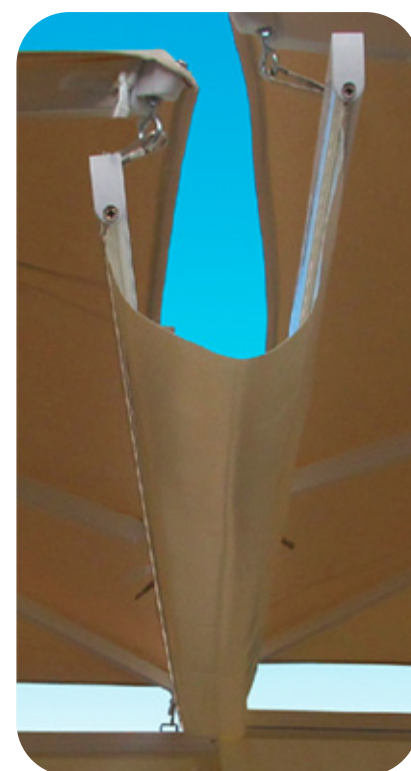

Herrajes de montaje  
incluidos

Assembly hardware included

Visserie incluse

**TEJIDOS DISPONIBLES**  
AVAILABLE FABRICS  
TISSUS DISPONIBLES

**Acrylic**  
Masa Forte

**PVC**

**MEDIDAS**  
SIZES  
DIMENSION

Ancho estándar 34/48 cm para: 2, 3, 4 y 5 m  
Suitable for sizes (standard wide 30-40 cm) : 2, 3, 4 and 5 m  
Dimension (largeur standard 30-40 cm) : 2, 3, 4 et 5 m

**SUJECIÓN**  
MOUNTING  
FIXATION

Mediante perfiles de aluminio + herrajes  
By aluminium poles + hardware  
Sur profilés en aluminium + raccords

## BASES

### BASES DE PARASOL

# Cemento pintado

## CONCRETE PARASOL BASES / PIEDS DE PARASOL CIMENT

### CARACTERISTICAS GENERALES / GENERAL CHARACTERISTICS / CARACTÉRISTIQUES GÉNÉRALES

- **Pintura:** Resistente al agua, ignífuga. Color gris.
- **Tubo de hierro,** pintura antióxido.
- **Tacos de goma** antirrayadura.
- **Paint:** Water-resistant, fireproof (grey colour).
- **Tube of iron** (rustproofing paint).
- **Rubber pads** to avoid scratching floors.
- *Peinture grise : Résistante. Ignifuge*
- *Tube métallique antirouille*
- *Patins en caoutchouc pour éviter de rayer le sol.*

Embalado en caja de cartón con molde de poliestireno.

Packed in cardboard box with polystyrene mold.

Emballé dans une boîte en carton avec moule en polystyrène.

TH  
12



TH  
22



TH  
30



DTH  
25

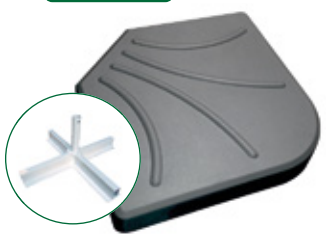

TH  
137



LTH  
35

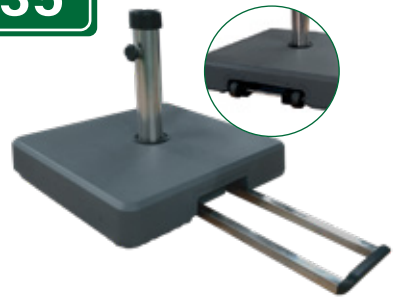

LTH  
50



MV  
50N



NOVEDAD

NOVEDAD



GY  
20 GY  
30 GY  
50 GY  
70

Con aro protector  
With protective ring  
Avec anneau de protection

Ref	MATERIAL MATERIAL MATÉRIAU	PESO WEIGHT POIDS	MEDIDA MEASURE DIMENSIONS	MÁRGEN Ø TUBO TUBE RANGE POUR MÂTS
TH12	Cemento	11 kg.	36x36x5 cm.	Ø30-Ø38 mm.
TH22	Cemento	22 kg.	Ø48x5,5 cm.	Ø38-Ø48 mm.
TH30	Cemento	30 kg.	50x50x8 cm.	Ø38-Ø48 mm.
TH137	Cemento	37 kg.	50x50x8 cm.	Ø38-Ø48 mm.
LTH35	Cemento	38 kg.	48x48x8 cm.	Ø38-Ø48 mm.
LTH50	Cemento	50 kg.	55x55x8 cm.	Ø40-Ø58 mm.
MV50N	Cemento	50 kg.	57x57x7 cm.	Ø 25-50 mm.
GY	Cemento	20 kg.	57x52x12,5 cm.	Ø35-48 mm.
		30 kg.	59,5x57x13 cm.	Ø35-48 mm.
		50 kg.	68x65x19 cm.	Ø38-Ø58 mm.
		70 kg.	75,5x73,5x20 cm.	Ø38-Ø58 mm.



BASES DE PARASOL

# Cemento con carcasa de resina / PPP

CONCRETE BASES WITH RESIN CASE AND PPP / PIEDS EN CIMENT RECOUVERT DE RÉSINE ET PPP

HS  
40



Super agarre  
Super grip  
Super adhérence

HSN  
40

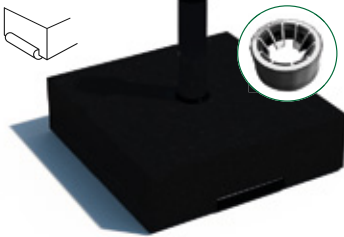

Super agarre  
Super grip  
Super adhérence

HS15  
HS20



Super agarre  
Super grip  
Super adhérence

NOVEDAD

MV  
21



NOVEDAD

MV  
39



Ref	MATERIAL MATERIAL MATÉRIAU	PESO WEIGHT POIDS	MEDIDA MEASURE DIMENSIONS	MÁRGEN Ø TUBO TUBE RANGE POUR MÂTS
HS40	Resina	40 kg.	40x40x12 cm.	Ø21-Ø54 mm.
HSN40	Resina	40 kg.	40x40x11 cm.	Ø21-Ø52 mm.
HS15	Resina	15 kg.	Ø40x9 cm.	Ø21-Ø35 mm.
HS20	Resina	20 kg.	Ø40x12 cm.	Ø21-Ø54 mm.
MV39	PPP	39 kg.	54x48.5x9 cm.	Ø 18-53 mm.
MV21	PPP	21 kg.	43x43x8 cm.	Ø 18-53 mm.

BASES DE PARASOL

# Plancha metálica

METAL PLATE BASE / PLANCHES MÉTALLIQUES

**BASEMP20**

**BASEMP40**

- Material: Hierro pintado.
- Pintura: electrostática epoxy.
- Pletina soldada para sujeción del mástil mediante pernos.
- Fijación mediante tornillo manual.
- Paint: Epoxy paint coating.
- Pole attachment by welded plate with bolts.
- Screw for manual fixing.
- *Matériau: Acier non galvanisé.*
- *Peinture: époxy.*
- *Tube fixé au socle avec 4 boulons.*



**Colores disponibles:**  
Available colors:  
Couleurs disponibles:

  
Blanco

  
Antracita

-  **20KG**  **Ø40mm**
-  **36KG**  **Ø40mm y Ø50 mm**

**COMPONENTES**  
COMPONENTS  
COMPOSANTS

- Tubo de 45 cm. de altura.
- 2 pomos de ajuste
- Tube 45 cm. tall.
- 2 fixing knobs
- Tube de 45 cm. de hauteur.
- 2 molettes de fixation

BASES DE PARASOL

# Metálicas

METAL BASES / PIEDS MÉTALLIQUES

**Colores disponibles:**  
Available colors:  
Couleurs disponibles:

  
Blanco

  
Antracita

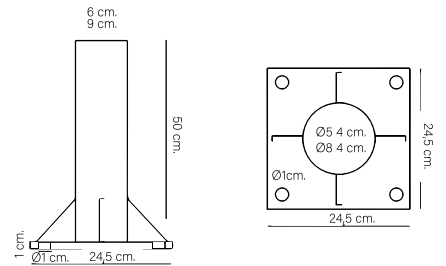
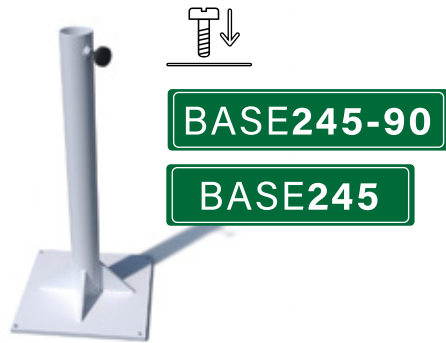

- Base de parasol para fijar.
- Disponible en 2 medidas:
    - Ref. BASE245: Tubo hasta Ø50 mm.
    - Ref. BASE245-90: Tubo hasta Ø90 mm.
  - Material: Hierro pintado.
  - Pintura: electrostática epoxy.

- Parasol base to anchor.
- 2 sizes available:
    - Ref. BASE245: Tube up to Ø50 mm.
    - Ref. BASE245-90: Tube up to Ø90 mm.
  - Material: Painted Iron.
  - Paint: Epoxy paint coating.

- Pieds de parasol pour fixer au sol.
- Ref. BASE245: Pour mât jusqu'à Ø50 mm.
  - Ref. BASE245-90: Pour mât jusqu'à Ø90 mm.
  - *Matériau: Acier non galvanisé*
  - *Peinture: époxy.*

- Base de cruz para parasol serie MÁSTER.
- Material: Hierro pintado con pintura electrostática (epoxy)
  - Peso / Medida: 14 kg. - 110x110 cm.
  - Para mástil parasol MÁSTER 3x3 / 4x4 o 3x4 m.

- Cross base for parasol MÁSTER series.
- Material: Iron, painted with electrostatic paint (epoxy)
  - Weight / Measures: 13 kg. - 110x110 cm.
  - For MÁSTER series umbrella poles, 3x3 or 4x4 m.

- Pieds de parasol exclusif parasols MASTER.
- *Matériau: Acier non galvanisé*
  - Poids / Dimensions: 13 kg. - 110x110 cm.
  - Pour tubes de parasol MASTER 3x3 et 4x4 m
  - *Peinture: époxy.*

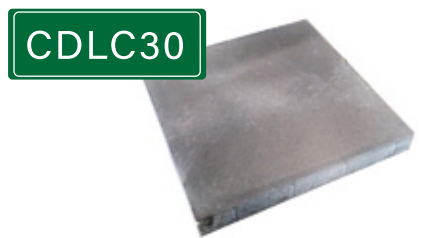



BASES DE PARASOL

# Metálicas empotrables

IN GROUND METAL BASE / PIEDS MÉTALLIQUE ENCASTRABLE

Base galvanizada empotrable con tapa.  
 - Material: Hierro pintado.  
 - Pintura: Oxidon

Galvanized recessed base with cover.  
 - Material: Painted iron.  
 - Painting: Oxidon

Base encastrée galvanisée avec couvercle.  
 - Matériau : Acier  
 - Peinture : Oxidon

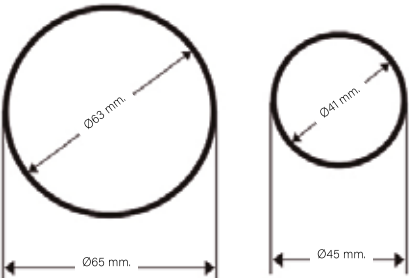
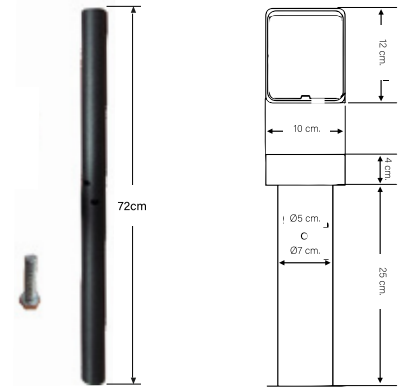

**BASE70ET**

**BASE50ET**



**3KG**



Hasta Ø50mm



**4KG**



Hasta Ø70mm

BASES DE PARASOL

# Jardinera metálica

METALLIC PLANTER / CAISSON MÉTALLIQUE

Base metálica con ruedas de freno.  
 - Material: Hierro  
 - Pintura: Poliéster exterior

Metal base with brake wheels.  
 - Material: Iron  
 - Paint: Exterior polyester

Caisson métallique avec 4 roues avec frein  
 - Matériau : Acier non galvanisé  
 - Peinture : Polyester pour extérieur



**Tubo de fijación /**  
**Fixing tube /**  
**Tube de fixation**

**245-90**  
 Ø 83 mm.  
**BASE 245**  
 Ø 54 mm.

**MPBASE01MR**



**58KG**



**62x62x72,5 cm**

# Terrace Parasols



# Eolo







**FLE XO** - white-taupe  
**MEET** - taupe-taupe  
**ROD** - taupe-terracota, sand-cappuccino

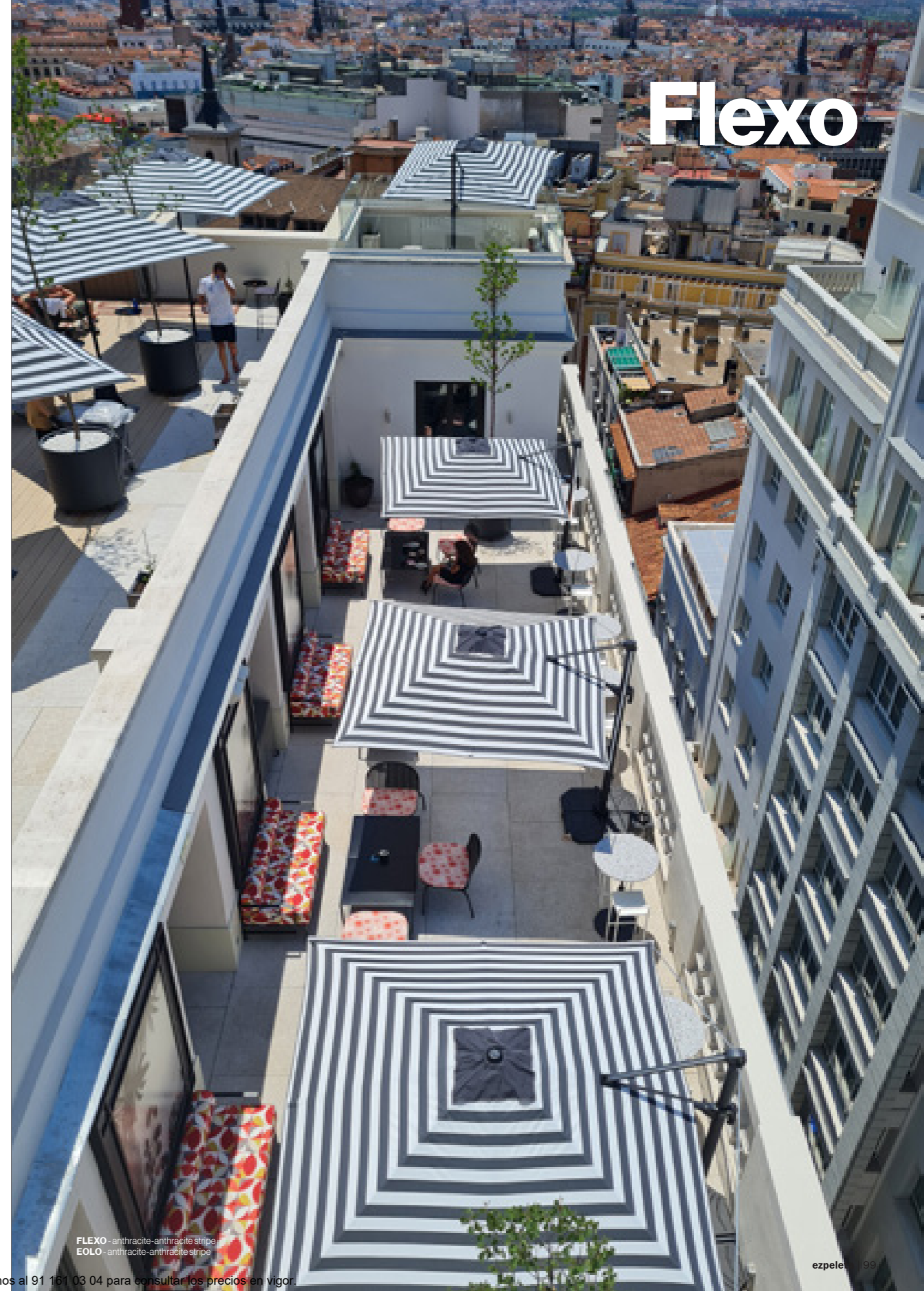

**Flexo**

**FLE XO** - anthracite-anthracite stripe  
**EOLO** - anthracite-anthracite stripe

# Rio



**RIO** - white - black  
**FIX RIO**  
**HALL** - anthracite

Los precios pueden estar desactualizados. Llámamos al 91 161 03 04 para consultar los precios en vigor.



**FORMENTERA** - white - sand  
**CROSS** - white  
**MONACO** - white-oak  
**DPCK** - white



# Formentera

**FORMENTERA** - anthracite - taupe  
**FASTCLICK**  
**MONACO** - sand-oak  
**HALL** - taupe



VIGO - white  
 MONACO - sand-white  
 FADO - aquamarine, sand



# Vigo

VIGO - anthracite  
 FLAT - grey  
 TOWN - anthracite  
 QUATRO - anthracite-anthracite, white-white

# Java



JAVA - taupe-stripe  
MEET - taupe-taupe  
ROD - taupe-terracota

# Small Parasols





**FARO** - white  
**QUATRO** - white-white  
**ATTIC** - white

# Faro & Creta



**CRETA** - anthracite  
**QUATRO** - taupe-stone  
**HOP** - anthracite



PALMA - white  
VILA - white  
LAND - white  
QUATRO - white-white



TENERIFE - Sand

# Palma & Tenerife





**TOSCANA**  
**MEET** - taupe-taupe  
**FADO** - taupe, aquamarine

# Toscana & Manila



**MANILA**  
**MEET** - white-white  
**DOCK** - brick

# Beach Parasols

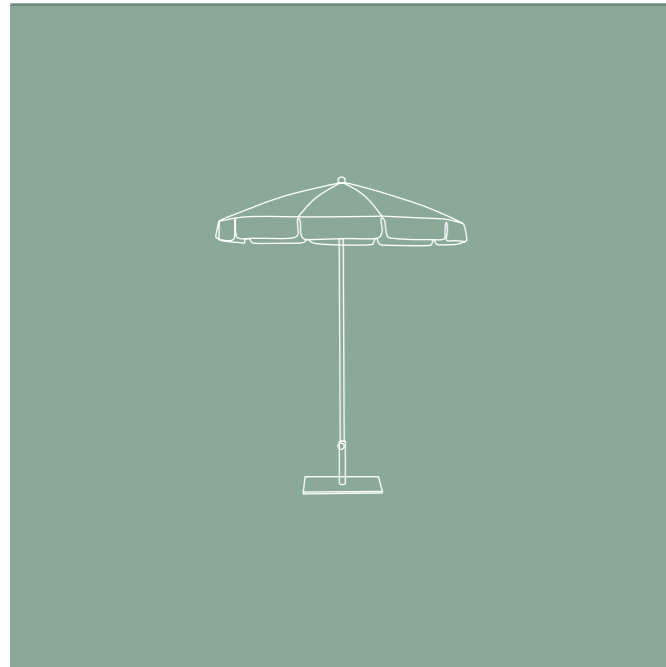

# Fold & Go



# Beach



### EOLO WHITE 2,5X2,5

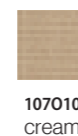
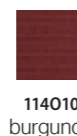
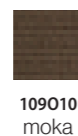
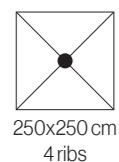
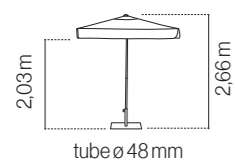

NEW

### SIAO10C2501740P

### EOLO WHITE 2,5X2,5

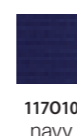
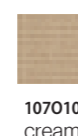
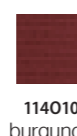
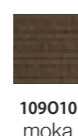
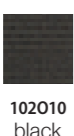
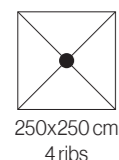
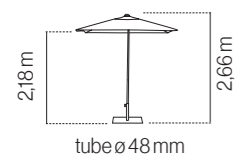

NEW

### SIAO10C2501721P

### EOLO TAUPE 2,5X2,5

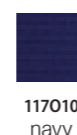
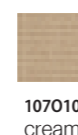
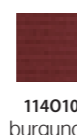
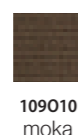
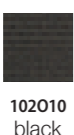
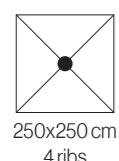
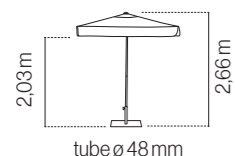

NEW

### SIAO10C2501840P

### EOLO TAUPE 2,5X2,5

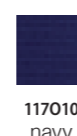
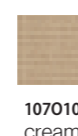
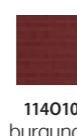
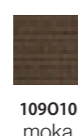
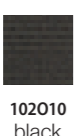
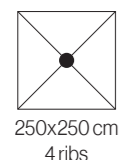
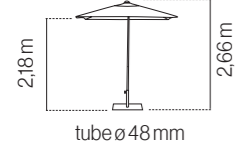

NEW

### SIAO10C2501821P

Parasol de aluminio lacado con 4 varillas (20x14mm). Apertura tipo push-up con sistema abre/cierra y pulsador de bloqueo. Con o sin volante y con fugavientos.

Guarda-sol em alumínio lacado com 4 varetas (20x14mm). Abertura tipo push-up com sistema abre/fecha e botão de bloqueio. Com ou sem bambinela e com fugavientos.

Lacquered aluminum parasol with 4 ribs (20x14mm). Easy push-up open system with an open-lock handle. With or without valance and with airvent.

Parasol aluminium laqué avec 4 balaines (20x14mm). Ouverture push-up avec système d'ouverture / fermeture et verrouillage. Avec ou sans volant et avec soufflet.

Registered design No. 007003710 - Utility model No. 201931894

Bases - Pieds - Pag. 178-179

CUBE - FIX - FAST CLICK - ROUND - MOULD - FLAT - CANTO - BOND



Handle for open, close and lock.



One piece runner and 4 ribs no screws. Exchangable ribs.



## EOLO ANTHRACITE 2,5X2,5

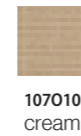
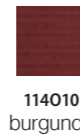
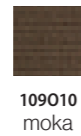
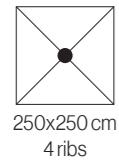
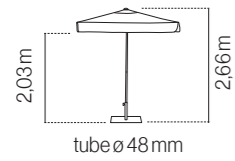

NEW

## SIAO10C2501640P

## EOLO ANTHRACITE 2,5X2,5

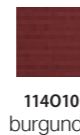
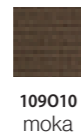
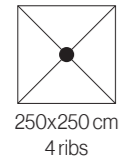
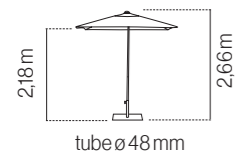

NEW

## SIAO10C2501621P

## EOLO PURETI 2,5X2,5

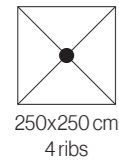
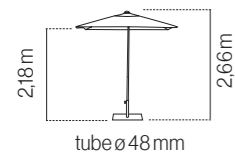

pureti



Parasol de aluminio lacado con 4 varillas (20x14mm). Apertura tipo push-up con sistema abre/cierra y pulsador de bloqueo. Con o sin volante y con fugavientos.

Guarda-sol em alumínio lacado com 4 varetas (20x14mm). Abertura tipo push-up com sistema abre/fecha e botão de bloqueio. Com ou sem bambinela e com fugavientos.

Lacquered aluminum parasol with 4 ribs (20x14mm). Easy push-up open system with an open-lock handle. With or without valance and with airvent.

Parasol aluminium laqué avec 4 balaines (20x14mm). Ouverture push-up avec système d'ouverture / fermeture et verrouillage. Avec ou sans volant et avec soufflet.

Registered design No. 007003710 - Utility model No. 201931894

Bases - Pieds: - Pag.178-179

CUBE - FIX - FAST CLICK - ROUND - MOULD - FLAT - CANTO - BOND

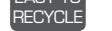
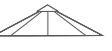

+ INFO



Joints with opening assistance.



Parasol descontaminante  
Guarda-sol descontaminante  
Air purifying parasol  
Parasol décontaminant  
ezepeleta.com/pureti

Parasol de aluminio lacado con 4 varillas (20x14mm). Apertura tipo push-up con sistema abre/cierra y pulsador de bloqueo. Sin volante y con fugavientos.

Guarda-sol em alumínio lacado com 4 varetas (20x14mm). Abertura tipo push-up com sistema abre/fecha e botão de bloqueio. Sem bambinela e com fugavientos.

Lacquered aluminum parasol with 4 ribs (20x14mm). Easy push-up open system with an open-lock handle. Without valance and with airvent.

Parasol aluminium laqué avec 4 balaines (20x14mm). Ouverture push-up avec système d'ouverture / fermeture et verrouillage. Sans volant et avec soufflet.

Registered design No. 007003710 - Utility model No. 201931894

Bases - Pieds: - Pag.178-179

CUBE - FIX - FAST CLICK - ROUND - MOULD - FLAT - CANTO - BOND



pureti

+ INFO



Al igual que los árboles, el tejido de este parasol descontamina el aire de las ciudades, neutraliza los gases de los motores y otras sustancias nocivas. Incorpora una nanotecnología que, en contacto con la luz solar, convierte las sustancias contaminantes del aire en sales inertes.

Tal como as árvores, o tecido deste guarda-sol descontamina o ar das cidades, neutraliza os gases dos motores e outras substâncias nocivas. Tem incorporada uma nanotecnologia que, em contacto com a luz solar, converte as substâncias contaminantes do ar em sais inertes.

Much like trees, the fabric of this umbrella reduces city pollution, neutralizing engine gases and other harmful substances. Its nanotechnology, upon contact with sunlight, turns air pollutants into inert salts.

Tout comme les arbres, le tissu de ce parasol décontamine l'air des villes et neutralise les gaz d'échappement des moteurs et d'autres substances nocives. Il intègre une nanotechnologie qui, en contact avec la lumière du soleil, transforme les substances contaminantes de l'air en sels inertes.

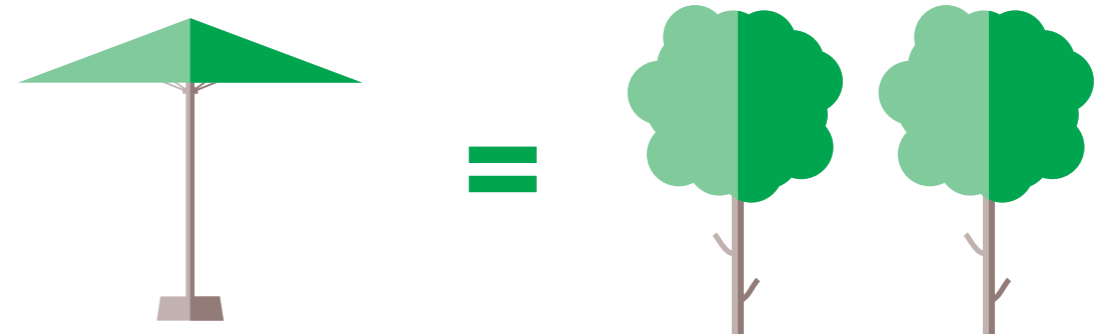

## EOLO WHITE 2X2

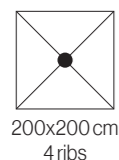
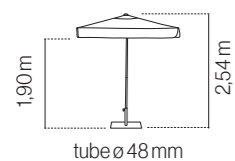

112010 white



103010 sand



101010 taupe



110010 anthracite



102010 black

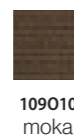

109010 moka

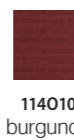

114010 burgundy



107010 cream



117010 navy



115010 taupe stripe



116010 anthracite stripe

NEW

## SPA010C2001740P

## EOLO WHITE 2X2

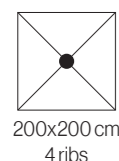
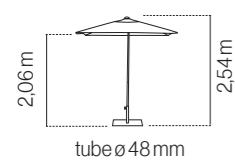

112010 white



103010 sand



101010 taupe



110010 anthracite



102010 black

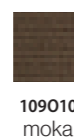

109010 moka

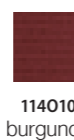

114010 burgundy

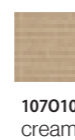

107010 cream

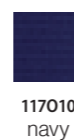

117010 navy



115010 taupe stripe



116010 anthracite stripe

NEW

## SPA010C2001720P

## EOLO TAUPE 2X2

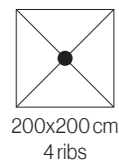
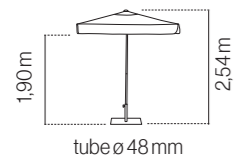

112010 white



103010 sand



101010 taupe



110010 anthracite



102010 black

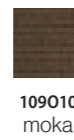

109010 moka

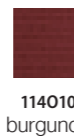

114010 burgundy

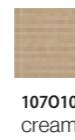

107010 cream



117010 navy



115010 taupe stripe



116010 anthracite stripe

NEW

## SPA010C2001840P

## EOLO TAUPE 2X2

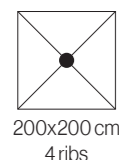
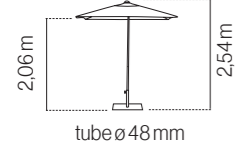

112010 white



103010 sand



101010 taupe



110010 anthracite

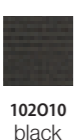

102010 black

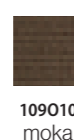

109010 moka

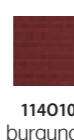

114010 burgundy

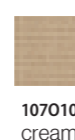

107010 cream

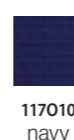

117010 navy



115010 taupe stripe



116010 anthracite stripe

NEW

## SPA010C2001820P

NEW

Parasol de aluminio lacado con 4 varillas (20x14mm). Apertura tipo push-up con sistema abre/cierra y pulsador de bloqueo. Con o sin volante y con fugavientos.

Guarda-sol em alumínio lacado com 4 varetas (20x14mm). Abertura tipo push-up com sistema abre/fecha e botão de bloqueio. Com ou sem bambinela e com fugavientos.

Lacquered aluminum parasol with 4 ribs (20x14mm). Easy push-up open system with an open-lock handle. With or without valance and with airvent.

Parasol aluminium laqué avec 4 balaines (20x14mm). Ouverture push-up avec système d'ouverture / fermeture et verrouillage. Avec ou sans volant et avec soufflet.

Registered design No. 007003710 - Utility model No. 201931894

Bases - Pieds: - Pag.178-179

CUBE - FIX - FAST CLICK - ROUND - MOULD - FLAT - CANTO - BOND



+ INFO



Handle for open, close and lock.



One piece runner and 4 ribs no screws. Exchangable ribs.



## EOLO ANTHRACITE 2X2

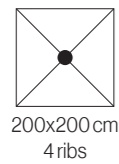
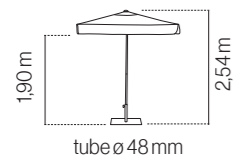

112010 white



103010 sand



101010 taupe



110010 anthracite



102010 black



109010 moka



114010 burgundy



107010 cream



117010 navy



115010 taupe stripe



116010 anthracite stripe

NEW

## SPA010C2001640P

## EOLO ANTHRACITE 2X2

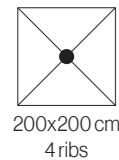
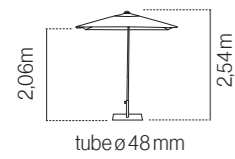

112010 white



103010 sand



101010 taupe



110010 anthracite



102010 black



109010 moka



114010 burgundy



107010 cream



117010 navy



115010 taupe stripe



116010 anthracite stripe

NEW

## SPA010C2001620P

## EOLO PURETI 2X2

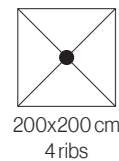
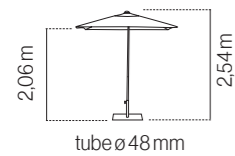

SPA010C2001721P  
112010 white



SPA010C2001821P  
101010 taupe



SPA010C2001621P  
110010 anthracite



pureti

Al igual que los árboles, el tejido de este parasol descontamina el aire de las ciudades, neutraliza los gases de los motores y otras sustancias nocivas. Incorpora una nanotecnología que, en contacto con la luz solar, convierte las sustancias contaminantes del aire en sales inertes.

Tal como as árvores, o tecido deste guarda-sol descontamina o ar das cidades, neutraliza os gases dos motores e outras substâncias nocivas. Tem incorporada uma nanotecnologia que, em contacto com a luz solar, converte as substâncias contaminantes do ar em sais inertes.

Much like trees, the fabric of this umbrella reduces city pollution, neutralizing engine gases and other harmful substances. Its nanotechnology, upon contact with sunlight, turns air pollutants into inert salts.

Tout comme les arbres, le tissu de ce parasol décontamine l'air des villes et neutralise les gaz d'échappement des moteurs et d'autres substances nocives. Il intègre une nanotechnologie qui, en contact avec la lumière du soleil, transforme les substances contaminantes de l'air en sels inertes.



Parasol de aluminio lacado con 4 varillas (20x14mm). Apertura tipo push-up con sistema abre/cierra y pulsador de bloqueo. Sin volante y con fugavientos.

Guarda-sol em alumínio lacado com 4 varetas (20x14mm). Abertura tipo push-up com sistema abre/fecha e botão de bloqueio. Sem bambinela e com fugaventos.

Lacquered aluminum parasol with 4 ribs (20x14mm). Easy push-up open system with an open-lock handle. Without valance and with airvent.

Parasol aluminium laqué avec 4 balaines (20x14mm). Ouverture push-up avec système d'ouverture / fermeture et verrouillage. Sans volant et avec soufflet.

Registered design No. 007003710 - Utility model No. 201931894

Bases - Pieds: - Pag. 178-179

CUBE - FIX - FAST CLICK - ROUND - MOULD - FLAT - CANTO - BOND



pureti

+ INFO



Joints with opening assistance.

Parasol de aluminio lacado con 4 varillas (20x14mm). Apertura tipo push-up con sistema abre/cierra y pulsador de bloqueo. Con volante y con fugavientos.

Guarda-sol em alumínio lacado com 4 varetas (20x14mm). Abertura tipo push-up com sistema abre/fecha e botão de bloqueio. Com bambinela e com fugaventos.

Lacquered aluminum parasol with 4 ribs (20x14mm). Easy push-up open system with an open-lock handle. With valance and with airvent.

Parasol aluminium laqué avec 4 balaines (20x14mm). Ouverture push-up avec système d'ouverture / fermeture et verrouillage. Avec volant et avec soufflet.

Registered design No. 007003710 - Utility model No. 201931894

Bases - Pieds: - Pag. 178-179

CUBE - FIX - FAST CLICK - ROUND - MOULD - FLAT - CANTO - BOND



+ INFO

QR code





## FLEHO WHITE 3X3

## SGA010C3005021P

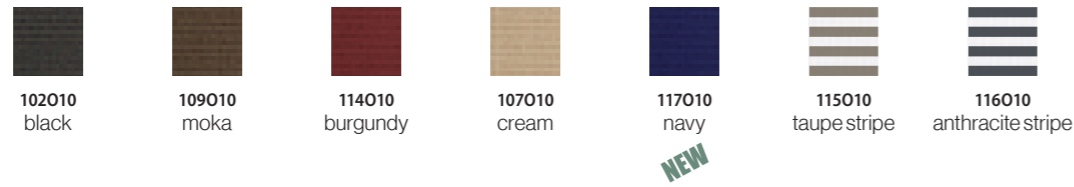
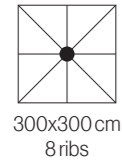
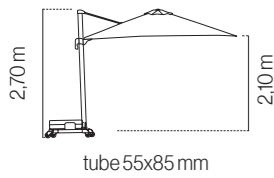

## FLEHO DARK TAUPE 3X3

## SGA010C3005022P

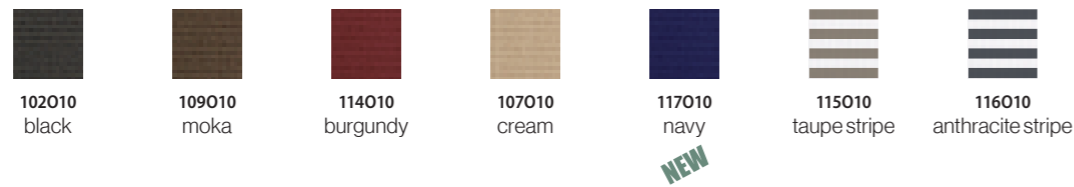
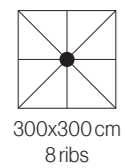
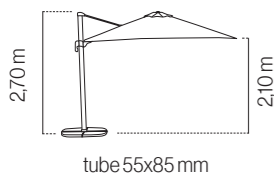

## FLEHO ANTHRACITE 3X3

## SGA010C3005020P

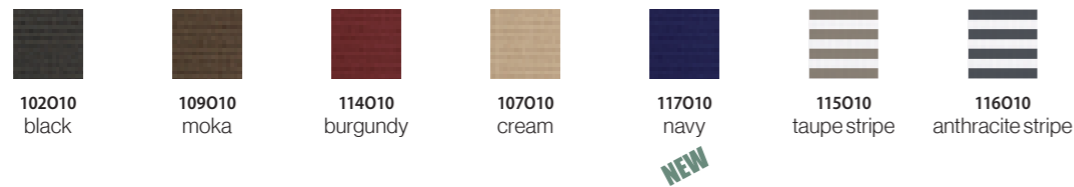
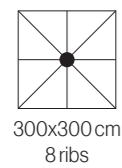
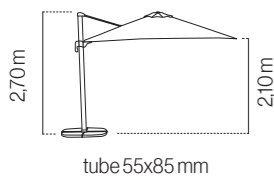

Parasol de aluminio 3x3 m de mastil lateral con inclinación. 8 varillas (17x25 mm). Giratorio 360°. Sistema estabilizador. Sin volante y con fugavientos.

Guarda-sol em alumínio 3x3 m. de haste lateral com inclinação. 8 varetas (17x25 mm). Giratório 360°. Sistema estabilizador. Sem bambelina e com fugavientos.

3x3 m. aluminium lateral pole parasol with tilt system. 8 ribs (17x25 mm). 360° rotatory system. Stabilizer system. Without valance and with airvent.

Parasol mât 3x3 m. latéral avec inclinaison. 8 baleines (17x25 mm). Rotatif 360°. Système stabilisateur. Sans volant et avec soufflet.

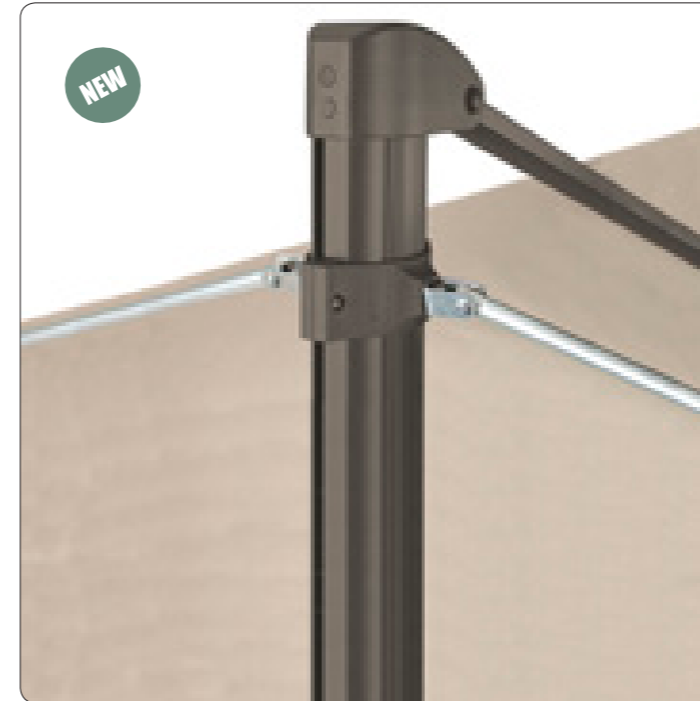

Sistema estabilizador. Stabilizer system.  
Système stabilisateur.

(Cruceta incluida / cruzeta incluída / cross included / croix incluse)

Bases - Pieds: - Pag. 178-179  
SLABX4 - FLEHO + SLABX6

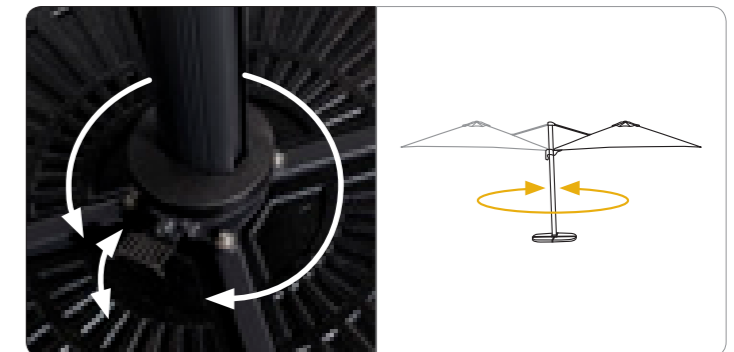
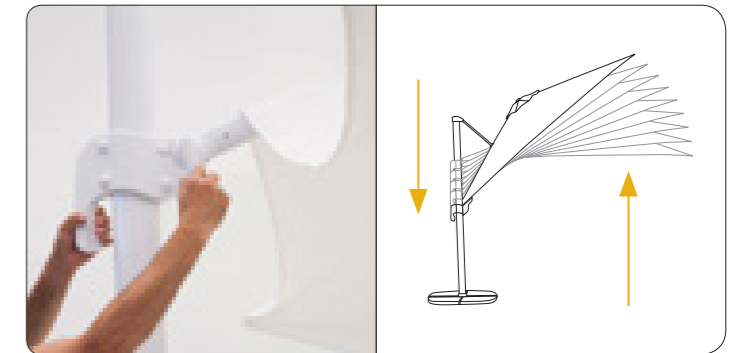

## RIO WHITE 4X4

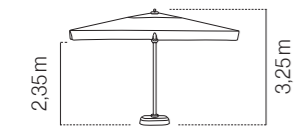

tube 71x71mm

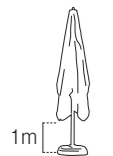

telescopic

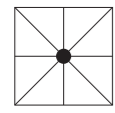

400x400 cm  
8 ribs



212020 white



203020 sand



201020 taupe



210020 anthracite



202020 black

## SGAO20C4000240P

## RIO WHITE 4X4

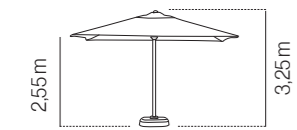

tube 71x71mm

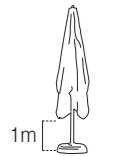

telescopic

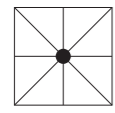

400x400 cm  
8 ribs



212020 white



203020 sand



201020 taupe



210020 anthracite



202020 black

## SGAO20C4000220P

## RIO ANTHRACITE 4X4

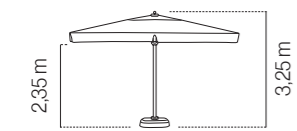

tube 71x71mm

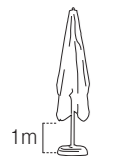

telescopic

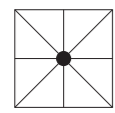

400x400 cm  
8 ribs



212020 white



203020 sand



201020 taupe



210020 anthracite



202020 black

## SGAO20C4000440P

## RIO ANTHRACITE 4X4

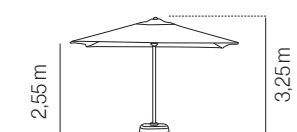

tube 71x71mm

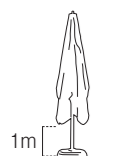

telescopic

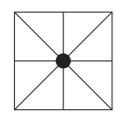

400x400 cm  
8 ribs



212020 white



203020 sand



201020 taupe

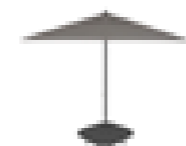

210020 anthracite



202020 black

## SGAO20C4000420P

Parasol de aluminio lacado para terrazas grandes 4x4 m. 8 varillas intercambiables (20x35x1,5 mm). Apertura asistida manivela. Telescópico. Con o sin volante y con fugavientos.

Guarda-sol em alumínio lacado para esplanadas grandes 4x4 m. 8 varetas intercambiáveis (20x35x1,5 mm). Abertura assistida manivela. Telescópico. Com ou sem bambinela e com fugaventos.

Lacquered 4x4 m. aluminium parasol for big terraces. 8 exchangeable ribs (20x35x1,5 mm). Crank-assisted opening system. Telescopic. With or without valance and with airvent.

Parasol aluminium laqué pour grande terrasse 4x4 m. 8 baleines interchangeables (20x35x1,5 mm). Ouverture assistée manivelle. Téléscopique. Avec ou sans volant et avec soufflet.

Bases - Pieds: - Pag. 178-179

CROSS RIO + SLABX4 - FIX RIO - FAST CLICK RIO

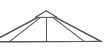

OLEFIN  
FIBER  
250g

SEE PAG.  
160-161  
FOR NEW  
WATER  
PROOF  
OPTION

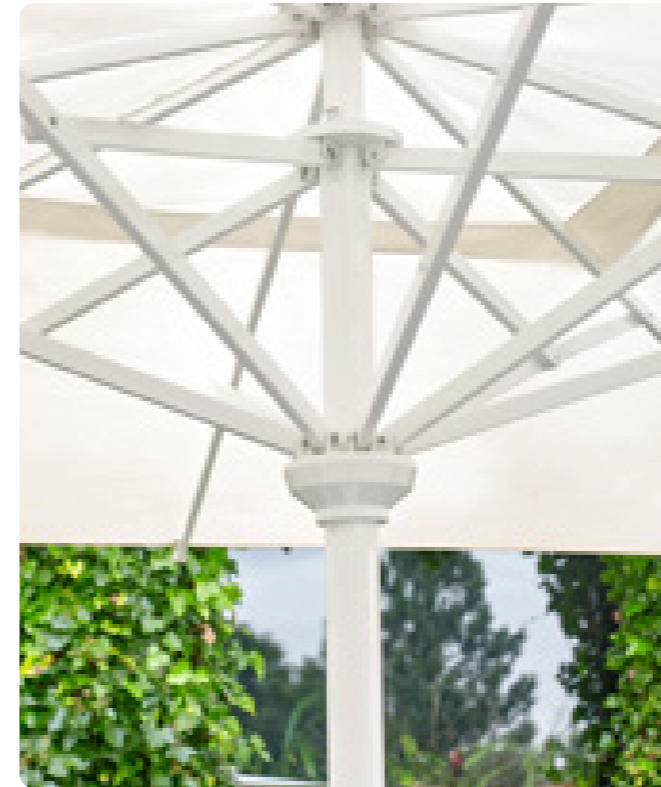

Exchangeable ribs.



NEW

## FORMENTERA WHITE 3X3

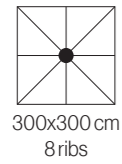
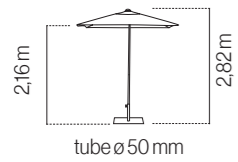

112010 white



103010 sand



101010 taupe



110010 anthracite

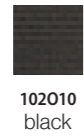

102010 black

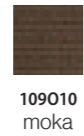

109010 moka

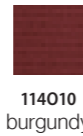

114010 burgundy

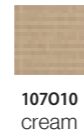

107010 cream

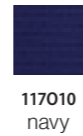

117010 navy

NEW



115010 taupe stripe



116010 anthracite stripe

## SGAO10C3000220P

## FORMENTERA ANTHRACITE 3X3

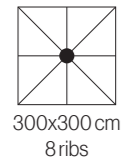
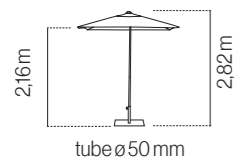

112010 white



103010 sand



101010 taupe



110010 anthracite

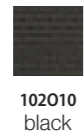

102010 black

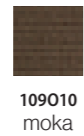

109010 moka

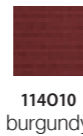

114010 burgundy



107010 cream

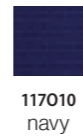

117010 navy

NEW



115010 taupe stripe



116010 anthracite stripe

## SGAO10C3500120P

## FORMENTERA WHITE 3,5X3,5

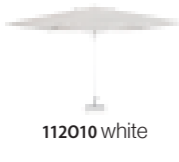
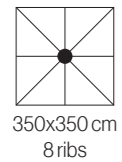
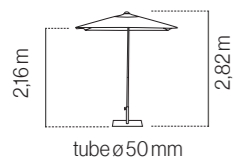

112010 white

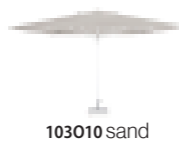

103010 sand



101010 taupe



110010 anthracite



102010 black

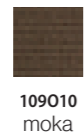

109010 moka

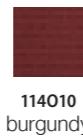

114010 burgundy



107010 cream

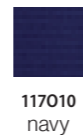

117010 navy

NEW



115010 taupe stripe



116010 anthracite stripe

## FORMENTERA ANTHRACITE 3,5X3,5

## SGAO10C3500320P

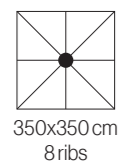
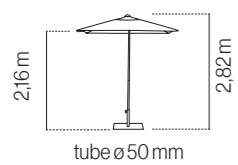

112010 white

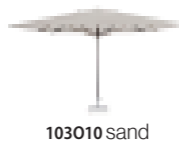

103010 sand



101010 taupe



110010 anthracite



102010 black

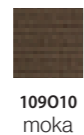

109010 moka

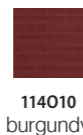

114010 burgundy



107010 cream

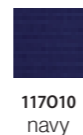

117010 navy

NEW



115010 taupe stripe



116010 anthracite stripe

Parasol de aluminio lacado. 8 varillas (30x20 mm). Apertura por poleas. Sin volante y con fugavientos.

Guarda-sol em alumínio lacado. 8 varetas (30x20 mm). Abertura por roldanas. Sem bambinela e com fugavientos.

Lacquered aluminium parasol. 8 ribs (30x20 mm). Pulley opening system. Without valance and with airvent.

Parasol aluminium laqué. 8 baleines (30x20 mm). Ouverture par poulie. Sans volant et avec soufflet.

Bases - Pieds: - Pag. 178-179

CROSS + SLABX4 - CUBE - FIX - FAST CLICK - CANTO - BOND (3x3)

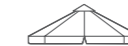

\* Opción con faldón también disponible. Consultar. / Opção com bambinela disponível. Consultar. / Option with valance also available. On request. / Option avec volant disponible. Sur demande.

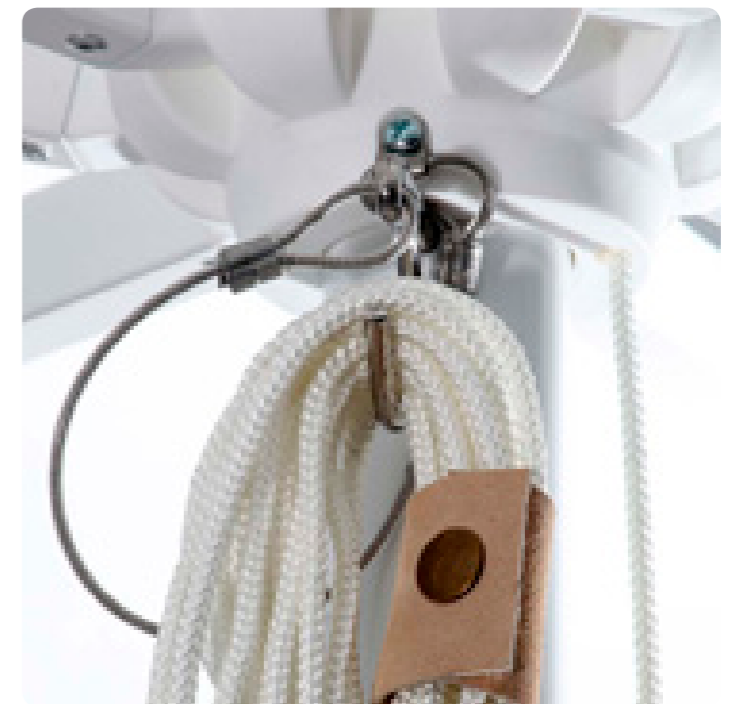

## RIO WHITE/ANTHRACITE 4X4 WATERPROOF

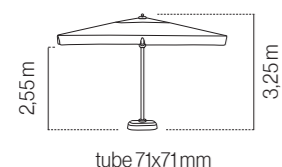

## FORMENTERA WHITE/ANTHRACITE 3,5X3,5 WATERPROOF

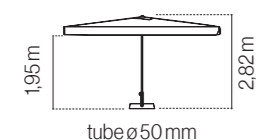

## FORMENTERA WHITE/ANTHRACITE 3X3 WATERPROOF

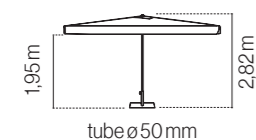

## CANALON/CALEIRA/GUTTER/GOUTTIÈRES

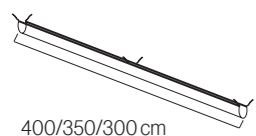

4x4 - IGAP00C40002  
3,5x3,5 - IGAP00C35002  
3x3 - IGAP00C30002



Nuevo tejido impermeable. 67% poliéster - 33% PVC.  
Compatible con todos los parasoles Rio y Formentera con faldón.

*Novo tecido impermeável. 67% poliéster - 33% PVC. Compatível com todos os guarda-sois Rio e Formentera com bambinela.*

New waterproof fabric. 67% polyester - 33% PVC. Compatible with all Rio and Formentera parasols with valance.

*Nouveau tissu imperméable. 67% polyester - 33% PVC. Compatible avec tous les parasols Rio et Formentera avec volant.*



EN343

Level 3. Highest level of rain protection.

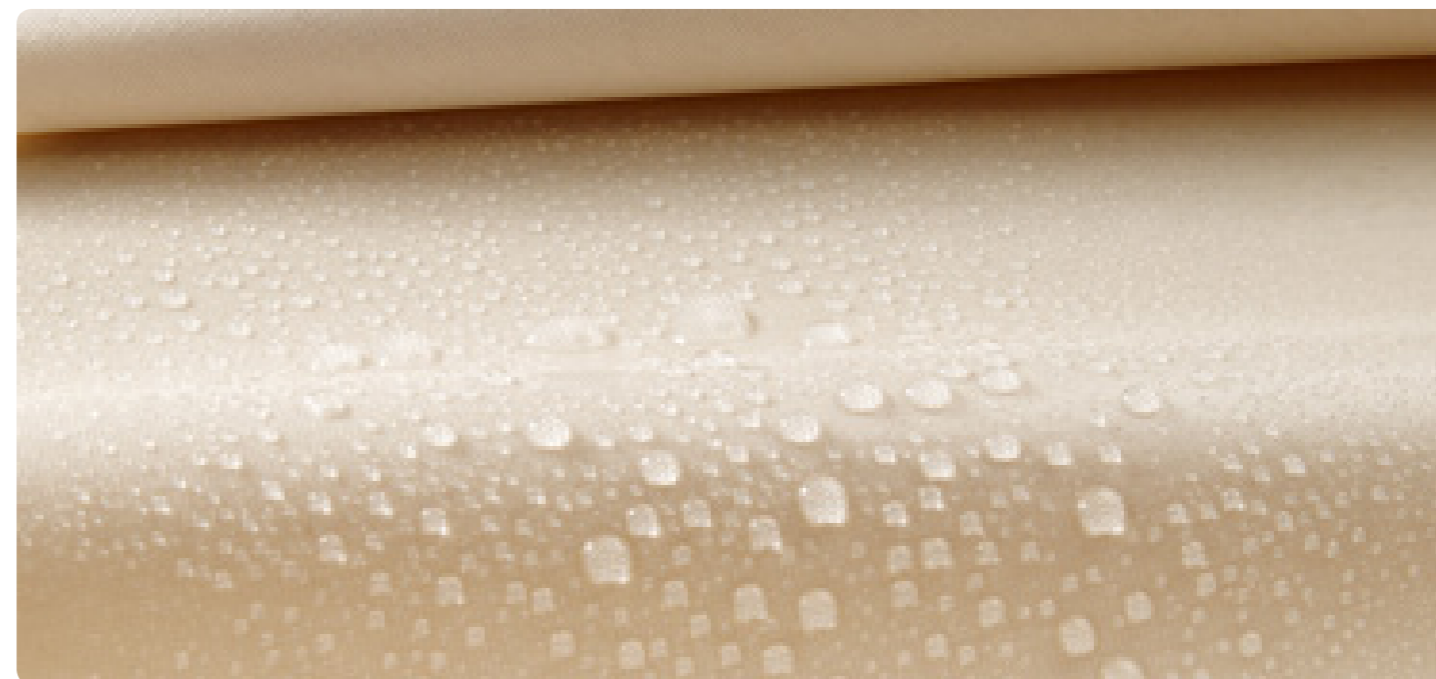

Canalones de unión impermeable. Protege la terraza de la lluvia uniendo dos parasoles. Canalón de PVC, varillas de aluminio y cintas con velcro de ajuste.

*Caleiras de união impermeável. Proteja a esplanada da chuva, unindo dois guarda-sóis. Caleiras em PVC, varetas de alumínio e tira de velcro de ajustar.*

Gutter of waterproof join. Protects your terrace from the rain by joining two parasols. PVC gutters, aluminium ribs and fastener velcro tape.

*Gouttières d'union imperméables. Protégez la terrasse de la pluie, en assemblant deux parasols. Gouttières en PVC, baleines en aluminium et bande en velcro pour ajuster.*

+ INFO



## VIGO GREY 2,5X2,5

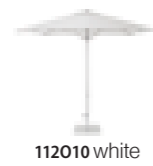
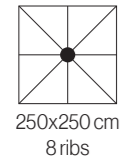
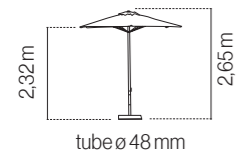

112010 white



103010 sand



101010 taupe



110010 anthracite

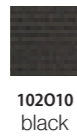

102010 black

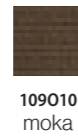

109010 moka

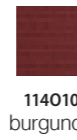

114010 burgundy

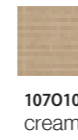

107010 cream

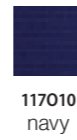

117010 navy

NEW



115010 taupe stripe

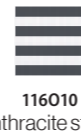

116010 anthracite stripe

## SIAO10C2500020P

## VIGO GREY 3X3

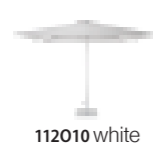
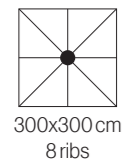
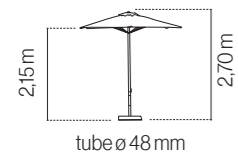

112010 white



103010 sand



101010 taupe



110010 anthracite

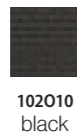

102010 black

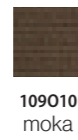

109010 moka

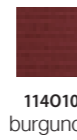

114010 burgundy

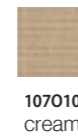

107010 cream



117010 navy

NEW



115010 taupe stripe



116010 anthracite stripe

## SGAO10C3000020P

## VIGO GREY 3X2

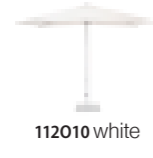
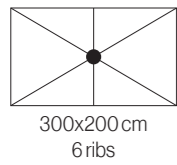
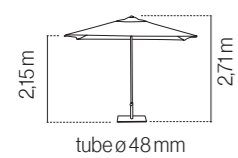

112010 white

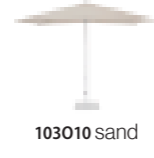

103010 sand



101010 taupe



110010 anthracite

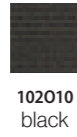

102010 black

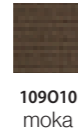

109010 moka

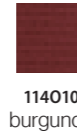

114010 burgundy

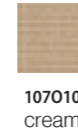

107010 cream

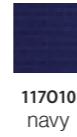

117010 navy

NEW



115010 taupe stripe

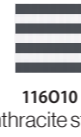

116010 anthracite stripe

## SGAO10H3000020P

## VIGO GREY 3

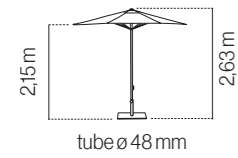

112010 white



103010 sand



101010 taupe



110010 anthracite

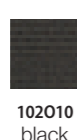

102010 black

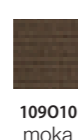

109010 moka

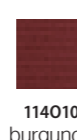

114010 burgundy

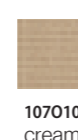

107010 cream



117010 navy

NEW



115010 taupe stripe

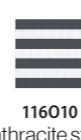

116010 anthracite stripe

## SIAO1003000820P

Parasol de aluminio lacado gris. 8 varillas (19x13 mm). Apertura por poleas. Sin volante y con fugavientos.

Guarda-sol em alumínio lacado cinza. 8 varetas (19x13 mm). Abertura por roldanas. Sem bambinela e com fugavientos.

Grey lacquered aluminium parasol. 8 ribs (19x13 mm). Pulley opening system. Without valance and with airvent.

Parasol aluminium laqué gris. 8 baleines (19x13 mm). Ouverture par poulie. Sans volant et avec soufflet.



Bases - Pieds: - Pag. 178-179

CROSS - CUBE - FAST CLICK - FIX - ROUND - MOULD - FLAT - CANTO - BOND



## JAVA 2X2

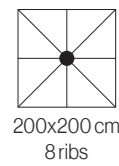
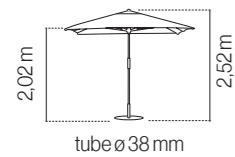

112010 white



103010 sand



101010 taupe



110010 anthracite

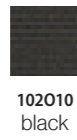

102010 black

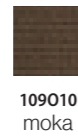

109010 moka

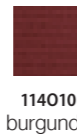

114010 burgundy

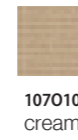

107010 cream

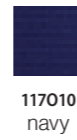

117010 navy

NEW



115010 taupe stripe



116010 anthracite stripe

## SPM010C2000020P



Parasol de madera de eucalipto barnizada. 8 varillas (17x22mm). Apertura por poleas. Sin volante y con fugavientos. Madera procedentes de fuentes sostenibles. Certificado FSC.  
Guarda-sol de madeira de eucalipto envernizada. 8 varetas (17x22mm). Abertura por roldanas. Sem bambinela e com fugaventos. Madeira proveniente de fontes reflorestadas. Certificado FSC.

Varnished eucalyptus wood parasol. 8 ribs (17x22mm). Pulley opening system. Without valance and with airvent. Wood from reforested sources. FSC certified.

Parasol bois d'eucalyptus verni. 8 baleines (17x22mm). Ouverture par poulie. Sans volant et avec soufflet. Bois provenant de sources reboisées. Certified FSC.

Bases - Pieds: - Pag. 178-179

CUBE - FAST CLICK - ROUND - CANTO



## JAVA 3X3

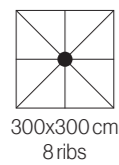
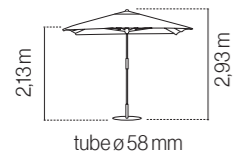

112010 white



103010 sand



101010 taupe



110010 anthracite

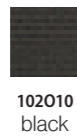

102010 black

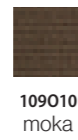

109010 moka

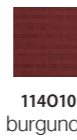

114010 burgundy

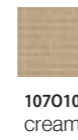

107010 cream



117010 navy

NEW



115010 taupe stripe



116010 anthracite stripe

## SGM010C3000020P

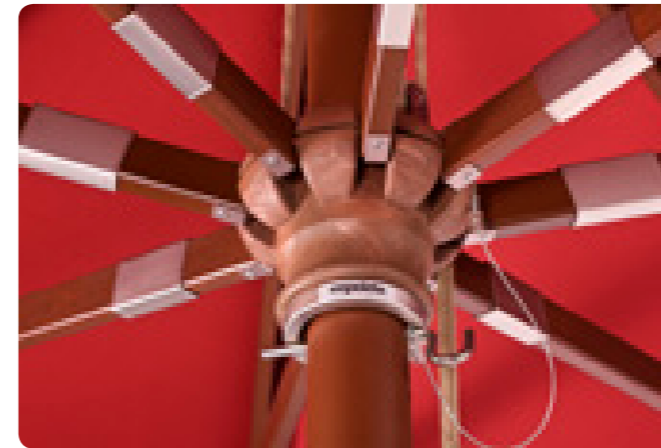

Parasol de madera de eucalipto barnizada. 8 varillas (17x35mm). Apertura por poleas. Sin volante y con fugavientos. Madera procedentes de fuentes sostenibles. Certificado FSC.  
Guarda-sol de madeira de eucalipto envernizada. 8 varetas (17x35mm). Abertura por roldanas. Sem bambinela e com fugaventos. Madeira proveniente de fontes reflorestadas. Certificado FSC.

Varnished eucalyptus wood parasol. 8 ribs (17x35mm). Pulley opening system. Without valance and with airvent. Wood from reforested sources. FSC certified.

Parasol bois d'eucalyptus verni. 8 baleines (17x35mm). Ouverture par poulie. Sans volant et avec soufflet. Bois provenant de sources reboisées. Certified FSC.

Bases - Pieds: - Pag. 178-179

CANTO



## JAVA 3

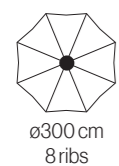
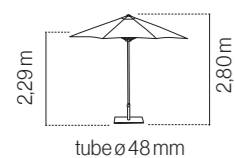

112010 white



103010 sand

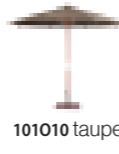

101010 taupe



110010 anthracite

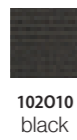

102010 black

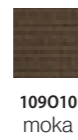

109010 moka

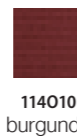

114010 burgundy

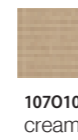

107010 cream



117010 navy

NEW



115010 taupe stripe



116010 anthracite stripe

## SIM01003000420P

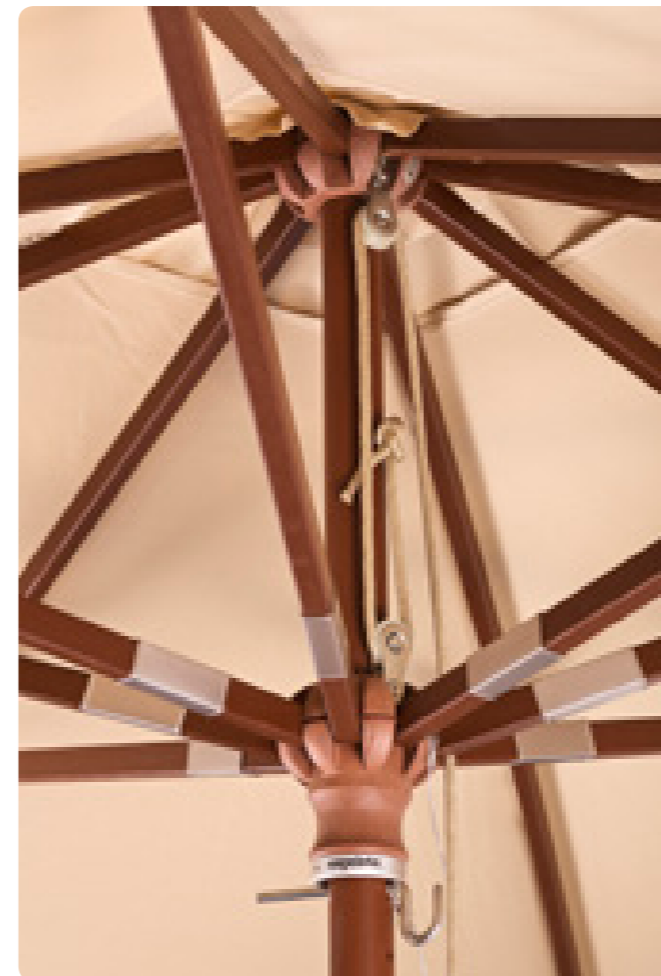
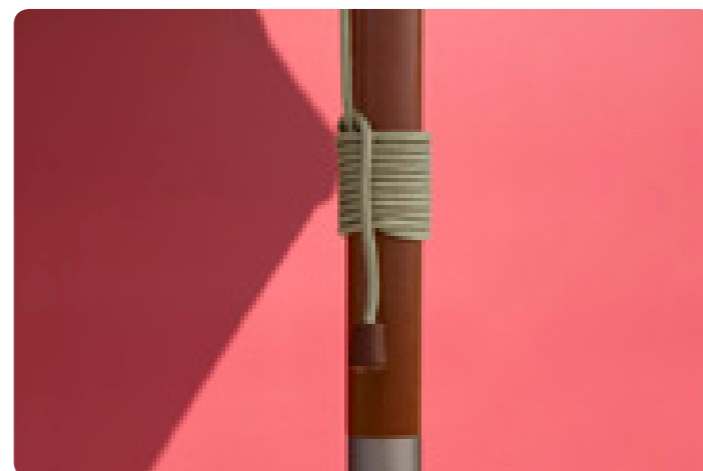

Parasol de madera de eucalipto barnizada. 8 varillas (17x22mm). Apertura por poleas. Sin volante y con fugavientos. Madera procedentes de fuentes sostenibles. Certificado FSC.  
Guarda-sol de madeira de eucalipto envernizada. 8 varetas (17x22mm). Abertura por roldanas. Sem bambinela e com fugaventos. Madeira proveniente de fontes reflorestadas. Certificado FSC.

Varnished eucalyptus wood parasol. 8 ribs (17x22mm). Pulley opening system. Without valance and with airvent. Wood from reforested sources. FSC certified.

Parasol bois d'eucalyptus verni. 8 baleines (17x22mm). Ouverture par poulie. Sans volant et avec soufflet. Bois provenant de sources reboisées. Certified FSC.

Bases - Pieds: - Pag. 178-179

CUBE - FAST CLICK - ROUND - FLAT - CANTO - BOND



## FARO INOX 2X2

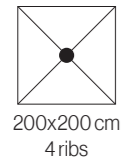
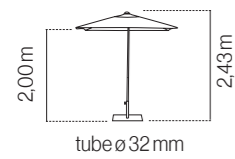

112010 white



103010 sand



101010 taupe



110010 anthracite



102010 black

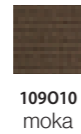

109010 moka

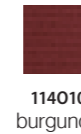

114010 burgundy

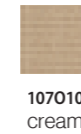

107010 cream



117010 navy

NEW



115010 taupe stripe



116010 anthracite stripe

## SPIO10C2000320P



Parasol de INOX. 4 varillas de fibra de vidrio (12,5 mm). Apertura Push-Up. Sin volante y con fugavientos.

Guarda-sol em INOX. 4 varetas de fibra de vidro (12,5 mm). Abertura Push-Up. Sem bambinela e com fugaventos.

INOX parasol. 4 fiberglass ribs (12,5 mm). Push-Up opening system. Without valance and with airvent.

Parasol INOX. 4 baleines en fibre de verre (12,5 mm). Ouverture Push-Up. Sans volant et avec soufflet.

Bases - Pieds: - Pag. 178-179

FLAT - ROUND - FIT



## CRETA GREY 2

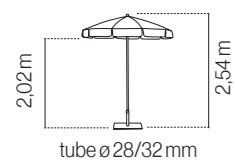

112010 white



103010 sand



101010 taupe



110010 anthracite



102010 black

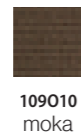

109010 moka

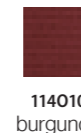

114010 burgundy



107010 cream



117010 navy

NEW



115010 taupe stripe



116010 anthracite stripe

## SPA010D2005210P



Parasol de aluminio con inclinación. 10 varillas de fibra de vidrio (6 mm). Regulable en altura. Con volante y sin fugavientos.

Guarda-sol em alumínio com inclinação. 10 varetas de fibra de vidro (6 mm). Regulável em altura. Com bambinela e sem fugaventos.

Aluminium parasol with tilt system. 10 fiberglass ribs (6 mm). Adjustable height. With valance and without airvent.

Parasol aluminium avec inclinaison. 10 baleines en fibre de verre (6 mm). Ajustable en hauteur. Avec volant et sans soufflet.

Bases - Pieds: - Pag. 178-179

FLAT - ROUND - FIT



## PALMA GREY 2,5

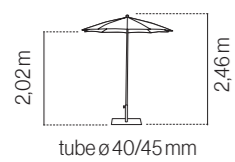

112010 white



103010 sand



101010 taupe



110010 anthracite



102010 black

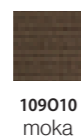

109010 moka

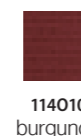

114010 burgundy



107010 cream

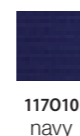

117010 navy

NEW



115010 taupe stripe



116010 anthracite stripe

## SIA0102500000P

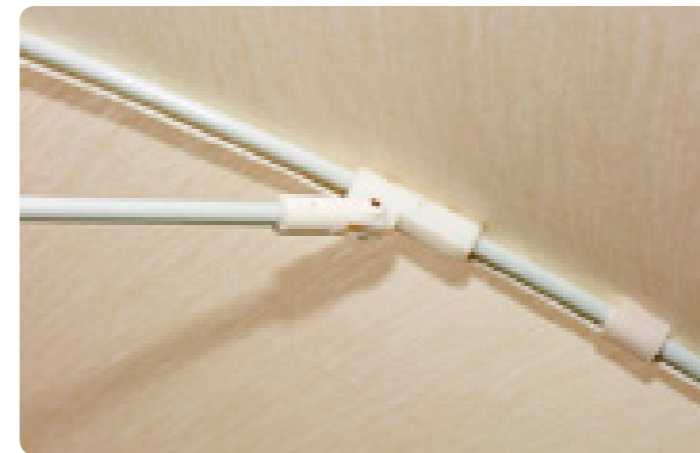

Parasol de aluminio. 8 varillas de fibra de vidrio (8 mm). Regulable en altura. Sin volante y sin fugavientos. Capito T extrarresistente.

Guarda-sol em alumínio. 8 varetas de fibra de vidro (8 mm). Regulável em altura. Sem bambinela e sem fugaventos. Tip T extraforte.

Aluminium parasol. 8 fiberglass ribs (8 mm). Adjustable height. Without valance and without airvent. Extrarresistant T tip.

Parasol aluminium. 8 baleines en fibre de verre (8 mm). Ajustable en hauteur. Sans volant et sans soufflet. Tip T extra forte.

Bases - Pieds: - Pag. 178-179

FLAT - ROUND - MOULD



## TENERIFE INOX 2

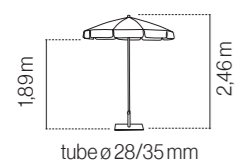

112010 white



103010 sand



101010 taupe



110010 anthracite



102010 black

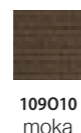

109010 moka

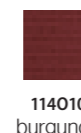

114010 burgundy



107010 cream

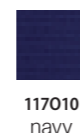

117010 navy

NEW



115010 taupe stripe



116010 anthracite stripe

## SPIO10D2005310P

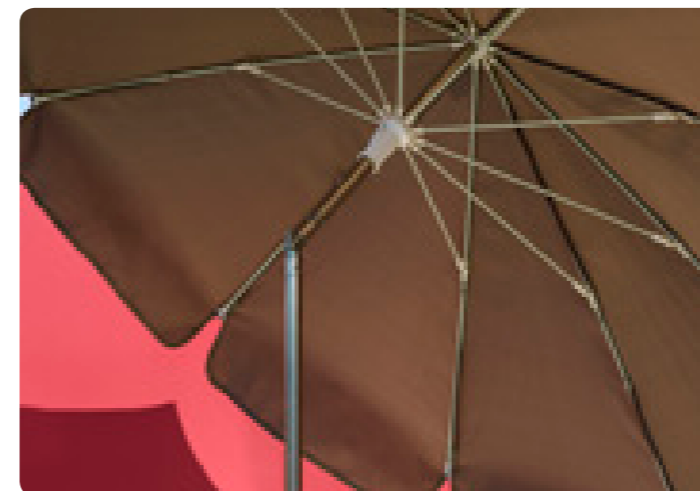

Parasol de INOX con inclinación. 10 varillas de fibra de vidrio (6 mm). Regulable en altura. Con volante y sin fugavientos. Capito T extrarresistente.

Guarda-sol em INOX com inclinação. 10 varetas de fibra de vidro (6 mm). Regulável em altura. Com bambinela e sem fugaventos. Tip T extraforte.

INOX parasol with tilt system. 10 fiberglass ribs (6 mm). Adjustable height. With valance and without airvent. Extrarresistant T tip.

Parasol INOX avec inclinaison. 10 baleines en fibre de verre (6 mm). Ajustable en hauteur. Avec volant et sans soufflet. Tip T extra forte.

Bases - Pieds: - Pag. 178-179

FLAT - ROUND - MOULD - FIT



## ONS SAND 2

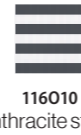
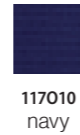
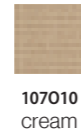
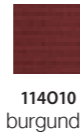
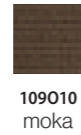
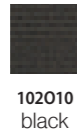
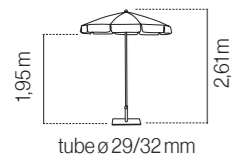

NEW

## SPA010D2000110T



Parasol de aluminio lacado sand. 10 varillas de fibra de vidrio (6 mm). Regulable en altura. Con volante y sin fugavientos. Capito T extrarresistente.

Guarda-sol em alumínio lacado sand. 10 varetas de fibra de vidro (6 mm). Regulável em altura. Com bambinela e sem fugavientos. Tip T extraforte.

Sand lacquered aluminium parasol. 10 fiberglass ribs (6 mm). Adjustable height. With valance and without airvent. Extrarresistant T tip.

Parasol aluminium laqué sand. 10 baleines en fibre de verre (6 mm). Ajustable en hauteur. Avec volant et sans soufflet. Tip T extra forte.

Bases - Pieds: - Pag. 178-179  
ROUND - FLAT - FIT



## TOSCANA SAND 2

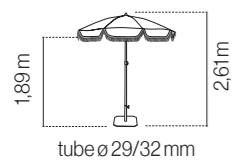

## SPAP10D2000110T

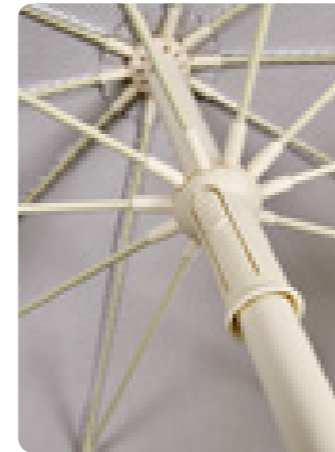

Parasol de aluminio lacado sand. 10 varillas de fibra de vidrio (6 mm). Regulable en altura. Con flecos. Con volante y sin fugavientos. Capito T extrarresistente.

Guarda-sol em alumínio lacado sand. 10 varetas de fibra de vidro (6 mm). Regulável em altura. Com franjas. Com bambelina e sem fugavientos. Tip T extraforte.

Sand lacquered aluminium parasol. 10 fiberglass ribs (6 mm). Adjustable height. With fringes. With valance and without airvent. Extrarresistant T tip.

Parasol aluminium laqué sand. 10 baleines en fibre de verre (6 mm). Ajustable en hauteur. Avec franges. Avec volant et sans soufflet. Tip T extra forte.

Bases - Pieds: - Pag. 178-179  
ROUND - FLAT - FIT



## MANILA NATURAL 2

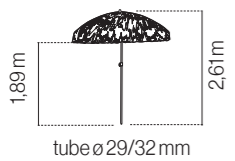

## SPSZ02D2000001T

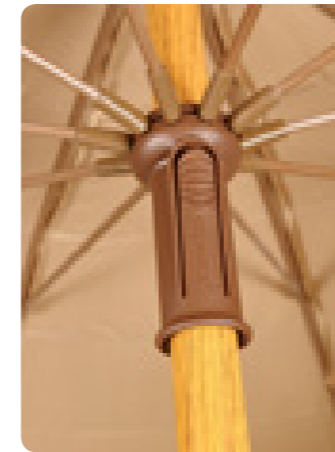
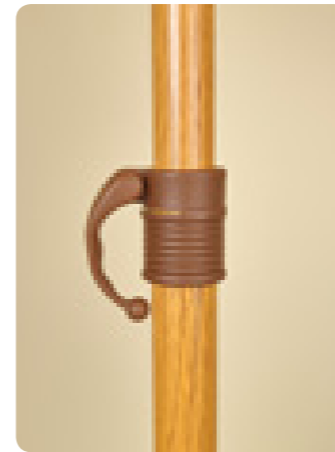

Parasol de acero imitación madera natural. 10 varillas de fibra de vidrio (6 mm). Regulable en altura. Con volante y sin fugavientos.

Guarda-sol em aço imitação madeira natural. 10 varetas de fibra de vidro (6 mm). Regulável em altura. Com bambelina e sem fugavientos.

Natural wood finishing steel parasol. 10 fiberglass ribs (6 mm). Adjustable height. With valance and without airvent.

Parasol acier finition bois naturel. 10 baleines en fibre de verre (6 mm). Ajustable en hauteur. Avec volant et sans soufflet.

Bases - Pieds: - Pag. 178-179  
ROUND - FIT



## FOLD & GO

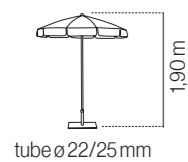

Parasol plegable de aluminio de 4 secciones. 8 varillas de fibra de vidrio de (5mm).

Guarda-sol de alumínio dobrá-vel de 4 seções. 8 varetas de fibra de vidro de (5mm).

Folding aluminium parasol. 4-sections. 8 fiber glass ribs (5mm).

Parasol pliant en aluminium laqué. 4 sections. 8 baleines en fibre de verre (5mm).



## BEACH

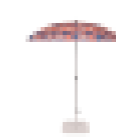
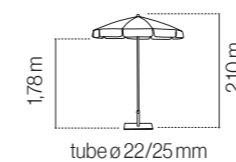

Parasol de aluminio de 2 secciones. 8 varillas de fibra de vidrio de (5mm).

Guarda-sol de alumínio de 2 seções. 8 varetas de fibra de vidro de (5mm).

Aluminium parasol. 2-sections. 8 fiber glass ribs (5mm).

Parasol en aluminium laqué. 2 sections. 8 baleines en fibre de verre (5mm).







REF. 31P18C40000  
RIO 400X4000

REF. 31P18C35000  
FORMENTERA 350X350  
FLEXO 300X300

REF. 31P18C30000  
FORMENTERA 300X300  
VIGO 300X300 - JAVA 300X300

REF. 31P18C25000  
EOLO - VIGO - JAVA



+ INFO

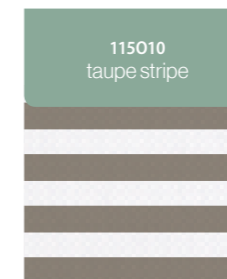
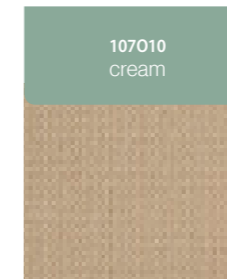
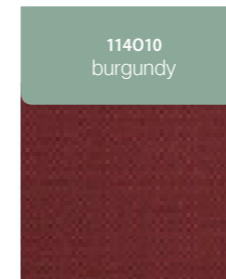
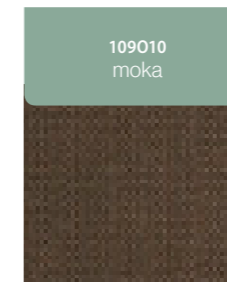
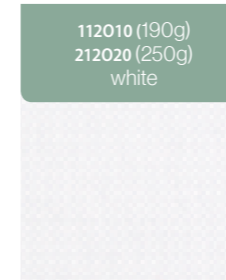
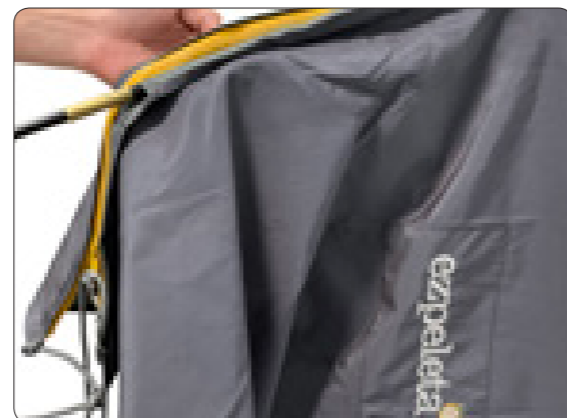
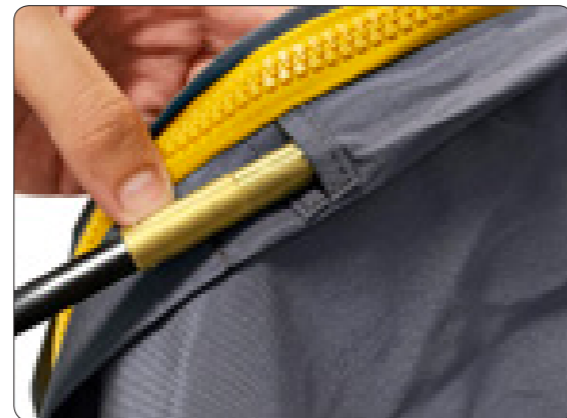

Alta solidez de los colores a la radicación UV. Se trata de un tejido fabricado con hilo de polipropileno que ha sido tintado en masa, en su proceso inicial. Esto le otorga una gran resistencia a la luz solar ya que el color queda fijado en el hilo del tejido con mayor intensidad que en otros procesos.

Certificación UV standard 801 con la puntuación UPF 80, que garantiza la protección de la piel de los efectos nocivos de los rayos UV.

Repelente al agua - resistente a las manchas - 100% reciclable.

*Alta resistência das cores face à radiação UV. Sendo um tecido fabricado com fio em polipropileno tingido em massa no seu processo inicial, esta característica confere-lhe uma maior resistência à luz solar o que se deve essencialmente ao facto de a cor permanecer fixada ao fio com maior intensidade do que em outros processos de pigmentação.*

*Certificação UV standard 801 com factor de proteção UPF 80, que garante a proteção da pele dos efeitos nocivos dos raios UV.*

*Repelente à água - anti-manchas - 100% reciclável.*

High resistance of colours to UV radiation. The fabric is made from polypropylene fabric mass-dyed during the initial process. This provides high resistance to sunlight because the colour is set in the thread of the fabric more intensely than in other processes.

UV standard 801 certification rating UPF 80, that guarantees skin protection against nocive effects of UV rays on the skin.

Water repellent - stain resistance - 100% recyclable.

*Haute résistance des couleurs face à la radiation solaire. Il s'agit ici d'une toile fabriquée à partir d'un fil en polypropylène qui a été teinté en masse, depuis son processus initial. Ceci lui confère une haute résistance à la lumière solaire, étant donné que la teinte reste fixée sur le fil avec une plus grande intensité en comparaison avec d'autres processus de pigmentation.*

*Certification UV standard 801 avec un factor de protection UPF 80, qui garantie une protection de la peau face aux effets nocifs des rayons UV.*

*Repellente à l'eau - résistant aux tâches - 100% recyclable.*



SOLUTION DYED - COLOUR FASTNESS: 7-8/8 - 100% RECYCLABLE

## SLAB (cemento - cemento - concrete - ciment)

Flexo

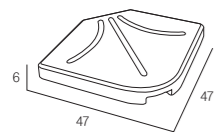

25kg  
100 kg (4 U/)



BEC047BC02  
white



BEC047NG01  
anthracite

## FLEXO (hierro /cemento - ferro/cimento - iron/concrete - fer/ciment)

Flexo

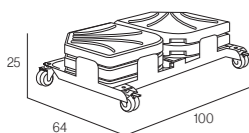

150kg + 15 kg (base)



BSH991BC + BEC047BC02  
FLEXO + SLABX6  
white



BSH990AN + BEC047NG01  
FLEXO + SLABX6  
anthracite

## CROSS (hierro /cemento - ferro/cimento - iron/concrete - fer/ciment)

Rio  
Formentera  
Vigo

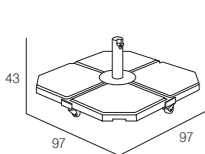

100kg + 10 kg (base)

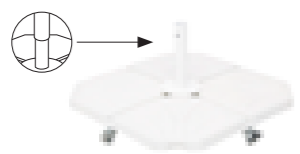

BSRDBC63501 + BEC047BC02  
CROSS RIO + SLABX4  
white



BSRDAN63500 + BEC047NG01  
CROSS RIO + SLABX4  
anthracite



BSRDBC5701 + BEC047BC02 -ø48-50  
CROSS + SLABX4  
white



BSRDAN5700 + BEC047NG01 -ø48-50  
CROSS + SLABX4  
anthracite

## CUBE (cemento - cemento - concrete - ciment)

Eolo  
Formentera  
Vigo  
Java 2X2  
Java 3

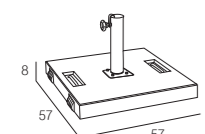

50kg  
poles ø38 - 50 mm



BEC570GR00  
grey



BEC570BC00  
white

## FIX (hierro - ferro - iron - fer)

Eolo  
Rio  
Formentera  
Vigo  
Java 3

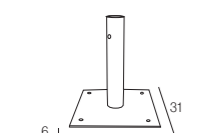

10kg  
poles ø48 - 50 mm

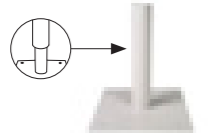

BSC310BC63501  
FIX RIO  
white



BSC310AN63500  
FIX RIO  
anthracite

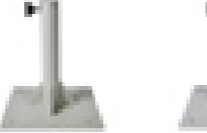

BSC310GR5703  
FIX  
grey



BSC310BC5701  
FIX  
white



BSC310TP5700  
FIX  
taupe

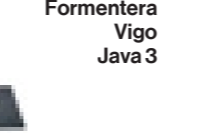

BSC310AN5700  
FIX  
anthracite

## FAST CLICK (inox)

Eolo  
Rio  
Formentera  
Vigo  
Java 2X2  
Java 3

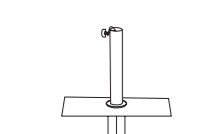

poles ø38 - 48 - 50 mm

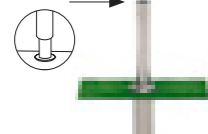

BIFC63500  
FAST CLICK RIO  
inox

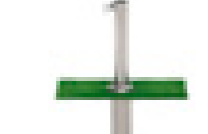

BIFC6000 -ø50  
FAST CLICK  
inox

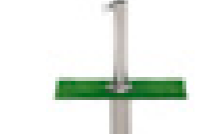

BIFC5500 -ø38-48  
FAST CLICK  
inox

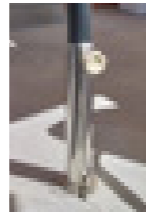

## ROUND (cemento - cemento - concrete - ciment)

Eolo  
Vigo  
Faro  
Creta  
Palma  
Tenerife  
Ons  
Toscana  
Manila

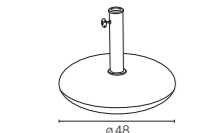

25kg  
poles ø32 - 48 mm

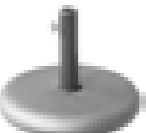

BER048GC01  
ROUND  
grey



BER048BC01  
ROUND EOLO  
white



BER048TP01  
ROUND EOLO  
taupe



BER048AN01  
ROUND EOLO  
anthracite

## MOULD (cemento/polipropileno - cemento/polipropileno - concrete/polypropylene - ciment/polypropylène)

Eolo  
Vigo  
Palma  
Tenerife

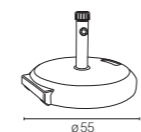

38kg  
poles ø35 - 48 mm



BER055GR00  
grey

## BOND (cemento/polipropileno - cemento/polipropileno - concrete/polypropylene - ciment/polypropylène)

Eolo  
Formentera 3x3  
Vigo  
Java 3

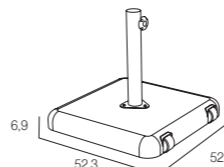

35kg  
poles ø48 - 50 mm

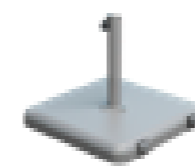

BPC523GR5700  
grey



BPC523BC5700  
white



BPC523TP5700  
taupe

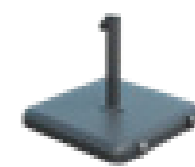

BPC523AN5700  
anthracite

## FLAT (hierro - ferro - iron - fer)

Eolo  
Vigo  
Faro  
Creta  
Palma  
Ons  
Toscana  
Java 2X2  
Java 3

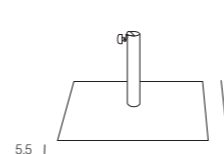

18kg  
poles ø32 - 38 - 40 - 48 mm

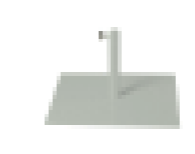

BSC625GR55030 -ø48  
BSC625GR40030 -ø32



BSC625BC5501 -ø48  
white

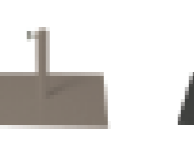

BSC625TP5500 -ø48  
taupe

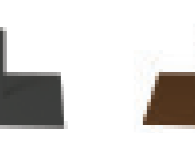

BSC625AN5500 -ø48  
anthracite

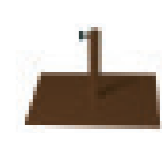

BSC625OX55000 -ø48  
BSC625OX45000 -ø38  
rust

## CANTO (hierro - ferro - iron - fer)

Eolo  
Formentera  
Vigo  
Java

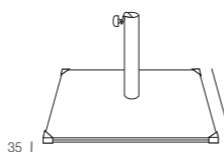

34kg  
poles ø48 - 58 mm

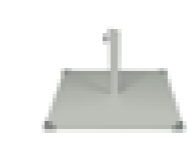

BSC625GR5710 -ø48-50  
grey



BSC625BC5710 -ø48-50  
white

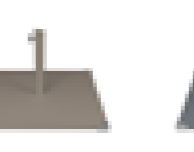

BSC625TP5710 -ø48-50  
taupe

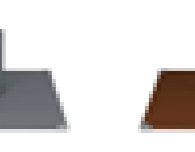

BSC625AN5710 -ø48-50  
anthracite



BSC625OX5710 -ø48-50  
BSC625OX7010 -ø58  
rust

## CANTO ACCESORIO - ACCESSORY



MO-SIE41K (kit 4 U/)  
Rueda con freno - roda com travão -  
wheels with brake - roue avec frein.

## FIT (hierro - ferro - iron - fer)

Faro  
Ons 200  
Creta  
Tenerife  
Manila  
Toscana

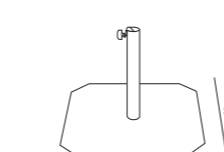

12kg  
poles ø32 - 35 mm



BSO500GR4003 -ø32  
BSO500GR4503 -ø35  
grey



BSO500BC4002 -ø32  
white



BSO500OX4000 -ø32  
rust

## TRAP (cemento - cemento - concrete - ciment)

Bora

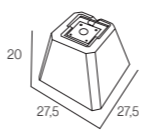

22kg  
poles ø25 mm



BEC020GR00  
grey

## POLYPROPYLENE



## COMPACT



## METAL



## OLEFIN

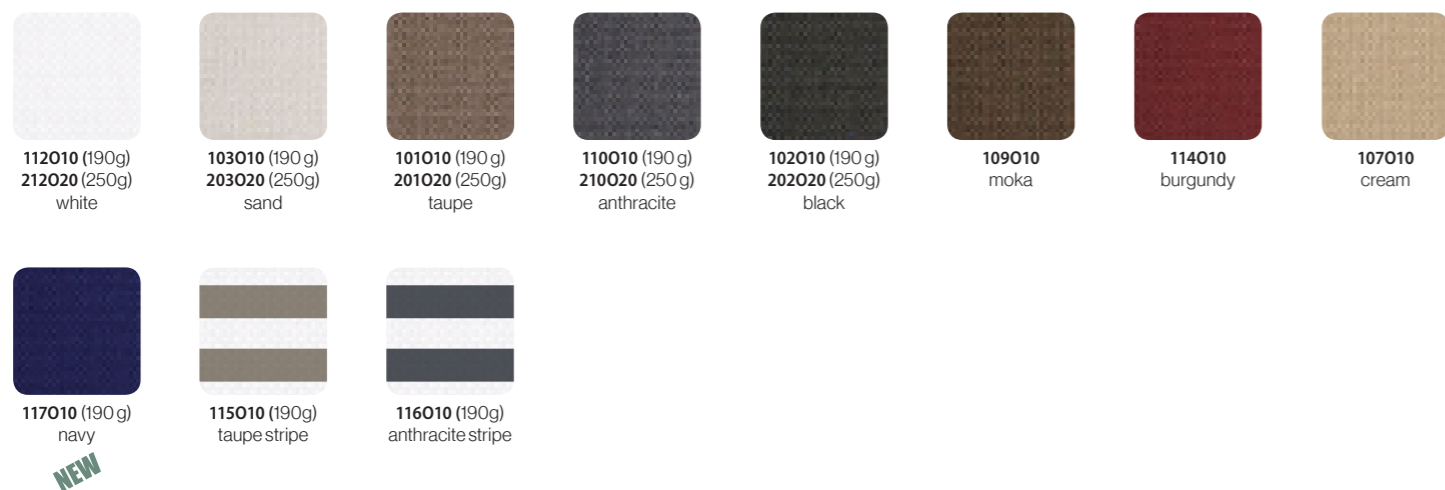

## PHIFERTEX®



## PAD



## NAUTIC



## AQUA



## WATERPROOF

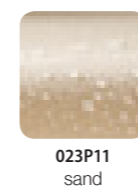

## DRALON® (Ibiza)

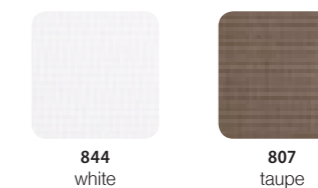

## Costa

Parasol

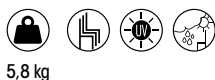

5,8 kg

Logística | Logistics | Logistique

	20'	40'	40 HC	70 m³	100 m³
	957	1939	1939	1988	-

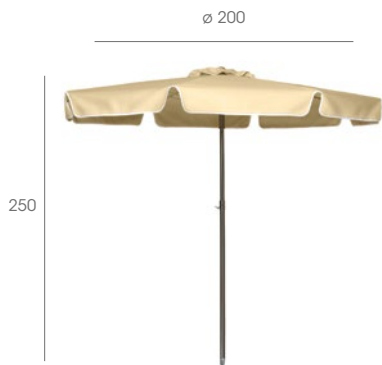

	CÓDIGO / CODE / CODE	PRECIO / PRICE / PRIX €/u.
	BEIGE BEIGE	59154
		191,50

## A2

Parasol



31 kg

Logística | Logistics | Logistique

	20'	40'	40 HC	70 m³	100 m³
	56	112	125	135	-



	CÓDIGO / CODE / CODE	PRECIO / PRICE / PRIX €/u.
	BEIGE BEIGE	66337
		1.005,00
	RECAMBIO TELA BEIGE BEIGE	66373
		166,50

## A2 Base

Pie  
Base  
Pied



10 kg

Logística | Logistics | Logistique

	20'	40'	40 HC	70 m³	100 m³
	1400	-	-	-	-



	CÓDIGO / CODE / CODE	PRECIO / PRICE / PRIX €/u.
	ACERO STEEL	66244
		170,00

## LA2

Parasol



26 kg

### Logística | Logistics | Logistique

	20'	40'	40 HC	70 m <sup>3</sup>	100 m <sup>3</sup>
	130	260	300	350	-

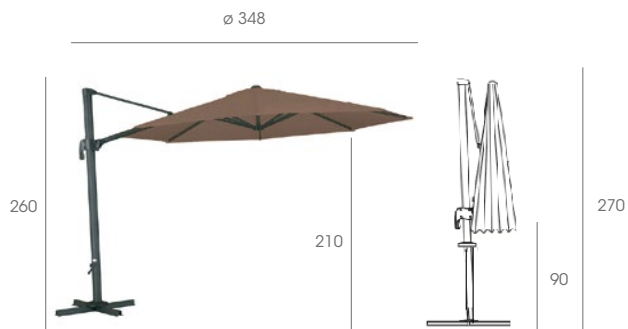

		PRECIO / PRICE / PRIX €/u.
	CÓDIGO / CODE / CODE	
	TALUPE TAUPE 59112	<b>645,00</b>
	BEIGE BEIGE 59118	
<b>RECAMBIO TELA</b>		
	TALUPE TAUPE 59151	<b>85,00</b>
	BEIGE BEIGE 59150	

## A1

Parasol



12,5 kg

### Logística | Logistics | Logistique

	20'	40'	40 HC	70 m <sup>3</sup>	100 m <sup>3</sup>
	316	484	770	792	1132



		PRECIO / PRICE / PRIX €/u.
	CÓDIGO / CODE / CODE	
	VERDE OSCURO DARK GREEN 66338	
	BEIGE BEIGE 66339	<b>242,50</b>
	BURDEOS BURGUNDY 66355	
<b>RECAMBIO TELA</b>		
	VERDE OSCURO DARK GREEN 66370	
	BEIGE BEIGE 66371	<b>61,50</b>
	BURDEOS BURGUNDY 66372	

## I1

Parasol



10,5 kg

### Logística | Logistics | Logistique

	20'	40'	40 HC	70 m <sup>3</sup>	100 m <sup>3</sup>
	242	484	572	528	572



		PRECIO / PRICE / PRIX €/u.
	CÓDIGO / CODE / CODE	
	ANTRACITA ANTHRACITE 66360	<b>288,50</b>
<b>RECAMBIO TELA</b>		
	ANTRACITA ANTHRACITE 59153	<b>66,50</b>

## AM1

Parasol



12,5 kg

Logística | Logistics | Logistique

	20'	40'	40 HC	70 m <sup>3</sup>	100 m <sup>3</sup>
	242	484	572	528	572



	PRECIO / PRICE / PRIX €/u.
CÓDIGO / CODE / CODE	
TAUPE TAUPE	66336 <b>263,00</b>

## M2

Parasol



6,5 kg

Logística | Logistics | Logistique

	20'	40'	40 HC	70 m <sup>3</sup>	100 m <sup>3</sup>
	800	1725	1900	2080	2794



	PRECIO / PRICE / PRIX €/u.
CÓDIGO / CODE / CODE	
MARFIL IVORY	66346 <b>97,00</b>
VERDE GREEN	66347
<b>RECAMBIOTELA REPLACEMENT FABRIC</b>	
MARFIL IVORY	66231 <b>28,00</b>
VERDE GREEN	66232

## A3

Parasol



4,5 kg

Logística | Logistics | Logistique

	20'	40'	40 HC	70 m <sup>3</sup>	100 m <sup>3</sup>
	-	1670	-	1569	-



	PRECIO / PRICE / PRIX €/u.
CÓDIGO / CODE / CODE	
BEIGE BEIGE	59114 <b>121,50</b>

## MD1

Parasol

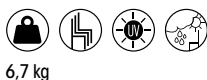

6,7 kg

Logística | Logistics | Logistique

	20'	40'	40 HC	70 m <sup>3</sup>	100 m <sup>3</sup>
	-	1152	-	1380	-



	PRECIO / PRICE / PRIX €/u.
CÓDIGO / CODE / CODE	
MARFIL BEIGE	66358 <b>78,50</b>

## One Push

Parasol



8,2kg

Logística | Logistics | Logistique

	20'	40'	40 HC	70 m <sup>3</sup>	100 m <sup>3</sup>
	533	1092	-	1316	-



	PRECIO / PRICE / PRIX €/u.
CÓDIGO / CODE / CODE	
BEIGE BEIGE	59124 <b>137,50</b>

## Sunray NEW

Parasol



18,6 kg

Logística | Logistics | Logistique

	20'	40'	40 HC	70 m <sup>3</sup>	100 m <sup>3</sup>
	710	1380	1590	2234	2320



	PRECIO / PRICE / PRIX €/u.
CÓDIGO / CODE / CODE	
MARFIL IVORY	59212
ANTRACITA ANTHRACITE	59213
	<b>719,00</b>
MARFIL IVORY	59214
ANTRACITA ANTHRACITE	59215
	<b>202,50</b>

RECAMBIO TELA  
REPLACEMENT FABRIC

## Siro 15

Pie  
Base  
Pied



15 kg

### Logística | Logistics | Logistique

	20'	40'	40 HC	70 m <sup>3</sup>	100 m <sup>3</sup>
	900	2300	-	2845	-



60

∅ 41,5

	CÓDIGO / CODE / CODE	PRECIO / PRICE / PRIX €/u.
	66245	50,50

## Siro 35

Pie  
Base  
Pied



35 kg

### Logística | Logistics | Logistique

	20'	40'	40 HC	70 m <sup>3</sup>	100 m <sup>3</sup>
	488	1190	-	1470	-



60

∅ 50

	CÓDIGO / CODE / CODE	PRECIO / PRICE / PRIX €/u.
	66246	106,00

## Siro 60 NEW

Pie  
Base  
Pied



60 kg

### Logística | Logistics | Logistique

	20'	40'	40 HC	70 m <sup>3</sup>	100 m <sup>3</sup>
	-	265	-	-	-



49

∅ 59

	CÓDIGO / CODE / CODE	PRECIO / PRICE / PRIX €/u.
	59226	240,00



## Siro 90

Pie  
Base  
Pied

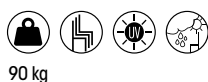

90 kg

### Logística | Logistics | Logistique

	20'	40'	40 HC	70 m <sup>3</sup>	100 m <sup>3</sup>
	-	265	-	-	-



ø 70

TUBO/TUBE

CÓDIGO / CODE / CODE

PRECIO / PRICE / PRIX  
€/u.

ø 70 mm		CEMENTO CEMENT	59187	
ø 59 mm		CEMENTO CEMENT	59205	
				<b>321,00</b>

## Flexo

Pie  
Base  
Pied



35 kg

### Logística | Logistics | Logistique

	20'	40'	40 HC	70 m <sup>3</sup>	100 m <sup>3</sup>
	520	-	-	-	-



| 1,8

49,5

CÓDIGO / CODE / CODE

PRECIO / PRICE / PRIX  
€/u.

	NEGRO BLACK	66247		<b>267,50</b>

## Stone 25

Pie  
Base  
Pied



25 kg

### Logística | Logistics | Logistique

	20'	40'	40 HC	70 m <sup>3</sup>	100 m <sup>3</sup>
	162	378	420	464	-

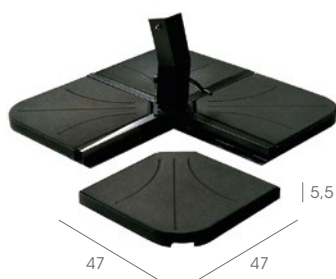

| 5,5

47

47

CÓDIGO / CODE / CODE

PRECIO / PRICE / PRIX  
€/u.

	NEGRO BLACK	66243		<b>63,00</b>

## Strong 150

Pie  
Base  
Pied



16 kg

### Logística | Logistics | Logistique

	20'	40'	40 HC	70 m <sup>3</sup>	100 m <sup>3</sup>
	172	368	435	444	-



PRECIO / PRICE / PRIX  
€/u.

CÓDIGO / CODE / CODE



NEGRO  
BLACK

66380



254,00

## Pie Parasol

Pie  
Base  
Pied



1,2 kg

### Logística | Logistics | Logistique

	20'	40'	40 HC	70 m <sup>3</sup>	100 m <sup>3</sup>
	1100	2300	2600	2725	3250

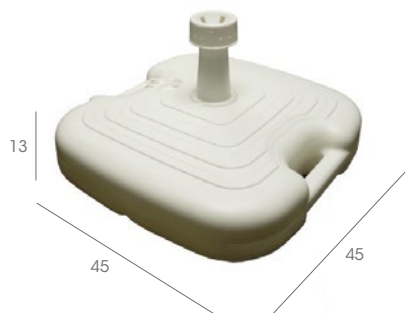

PRECIO / PRICE / PRIX  
€/u.

CÓDIGO / CODE / CODE



BLANCO  
WHITE

00119



10,00



VERDE OSCURO  
DARK GREEN

01373

11,00



ANTRACITA  
ANTHRACITE

06047

11,00

## Marquesina

Marquesina plegable  
Foldable marquee  
Tente pliante



71kg

### Logística | Logistics | Logistique

	20'	40'	40 HC	70 m <sup>3</sup>	100 m <sup>3</sup>
	91	182	-	-	-



PRECIO / PRICE / PRIX  
€/u.

CÓDIGO / CODE / CODE



MARRÓN  
BROWN

66359



792,50

## Brisa

Marquesina plegable  
Foldable marquee  
Tente pliante



44 kg

Logística | Logistics | Logistique

	20'	40'	40 HC	70 m³	100 m³
	-	-	-	-	-



		PRECIO / PRICE / PRIX €/u.	
CÓDIGO / CODE / CODE			
	BEIGE BEIGE	59171	<b>873,50</b>

## Vista

Pasarela  
Walkway  
Chemin pour plages



5 kg

Logística | Logistics | Logistique

	20'	40'	40 HC	70 m³	100 m³
	800	2000	2000	3600	4000
	800	2000	2000	3600	4000

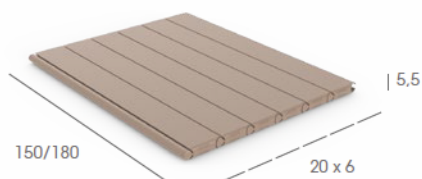

		PRECIO / PRICE / PRIX €/u.	
CÓDIGO / CODE / CODE			
150cm	BLANCO WHITE	59658	<b>35,50</b>
	ARENA SAND	59659	<b>33,00</b>
180cm	BLANCO WHITE	59660	<b>43,50</b>
	ARENA SAND	59661	<b>41,00</b>

## M7505

Armazón de aluminio lacado color gris.  
Mástil de una pieza, grosor 38mm.

Medidas: 2,1 mts Ø.

Altura: 2,40 mts

Tejido: Poliéster 100%. Repelente al agua. Con chimenea y sin faldón.

Color: Crudo.

Varillas: 4.

Soporte adecuado: 7710, 7720.



Precio 126 €

## M7510

Armazón de aluminio lacado color gris.  
Mástil de dos piezas, grosor 48mm.

Medidas: 3 mts Ø.

Altura: 2,60 mts

Tejido: Poliéster 100%. Repelente al agua.  
Con chimenea y faldón.

Color: Crudo.

Varillas: 8.

Soporte adecuado: 7710, 7720.

Opción: Este modelo permite personalización mediante serigrafía.



Precio 132 €

## M7535

Armazón de aluminio lacado color gris. Mástil de una pieza, grosor 38 mm.

Medidas: 2 x 2 mts.

Altura: 2 , 40 mts.

**Tejido:** Poliéster 100%. Repelente al agua. Con chimenea y sin faldón.

**Color:** Crudo.

**Varillas:** 4.

**Soporte adecuado:** 7710, 7720.

Precio 112 €



## M7540

Armazón de aluminio lacado color gris. Mástil de dos piezas, grosor 48 mm.

Medidas: 2,5 x 2,5 mts.

Altura: 2 , 60 mts.

**Tejido:** Poliéster 100%. Repelente al agua. Con chimenea y sin faldón.

**Color:** Crudo.

**Varillas:** 8.

**Soporte adecuado:** 7710, 7720.

Precio 123 €



## M7580

Armazón de aluminio lacado color gris. Mástil de dos piezas, grosor 48 mm.

Medidas: 3 x 3 mts.

Altura: 2 , 85 mts.

**Tejido:** Poliéster 100%. Repelente al agua. Con chimenea y sin faldón.

**Color:** Crudo.

**Varillas:** 8.

**Soporte adecuado:** 7710, 7720.

Precio 191 €



## M7560

Armazón de aluminio lacado color gris. Mástil de dos piezas, grosor 48 mm.

Medidas: 3 x 3 mts.

Altura: 2 , 85 mts.

**Tejido:** Poliéster 100%. Repelente al agua. Con chimenea y faldón.

**Color:** Crudo.

**Varillas:** 8.

**Soporte adecuado:** 7710, 7720.

**Opción:** Este modelo permite personalización mediante serigrafía.

Precio 207 €

## M7550

Armazón de aluminio lacado color gris.  
Mástil de dos piezas, grosor 48 mm.

Medidas: 2,5 x 2,5 mts.

Altura: 2,60 mts.

Tejido: Poliéster 100%. Repelente al agua.  
Con chimenea y con faldón.

Color: Crudo.

Varillas: 8.

Soporte adecuado: 7710, 7720.

Opción: Este modelo permite personalización mediante serigrafía.

Precio 144 €



## M7570

Armazón de aluminio lacado color gris.  
Mástil de dos piezas, grosor 48 mm.

Medidas: 2 x 3 mts.

Altura: 2,50 mts.

Tejido: Poliéster 100%. Repelente al agua.  
Con chimenea y sin faldón.

Color: Crudo.

Varillas: 6.

Soporte adecuado: 7710, 7720.

Opción: Este modelo permite personalización mediante serigrafía.

Precio 128 €



## M7710

SOPORTE PARASOL

Material: Plancha de hierro.

Dimensión base: 625x625 mm.

Diámetro tubo: 40-50mm.

Color: Blanco y marrón.

Peso: 20 Kg.

Precio 79 €



## M7720

SOPORTE PARASOL

Material: Hormigón con tubo de acero 40cm.

Diámetro base: Ø 500 mm.

Diámetro tubo: 48-58mm.

Color: Crudo (tubo negro).

Peso: 35 Kg.

Precio 64 €





Parasol M7550. Mesa Alta M357 tablero Compact. Taburete M5024.

## M7530



Armazón de aluminio lacado color gris.  
Mástil de dos piezas, grosor 90 x 50 mm.  
Incluye la cruz de soporte

Medidas: 3 x 3 mts.

Altura: 2,80 mts.

Extensión/abierto: 3,60 mts.

Tejido: Poliéster 100%. Repelente al agua.

Con chimenea y sin faldón.

Color: Crudo.

Varillas: 8.

Soporte adecuado: 7730.

Precio 478 €



## M7520

Armazón de aluminio lacado color gris.  
Mástil de dos piezas, grosor 80 mm.  
Incluye la cruz de soporte

Medidas: 4 x 4 mts.

Altura: 4,20 mts.

Tejido: Poliéster 100%. Repelente al agua.  
Con chimenea y sin faldón.

Color: Crudo.

Varillas: 8.

Soporte adecuado: 7730, 7740.

Precio 801 €



## M7900

Armazón de aluminio lacado color blanco.  
4 mástiles extensibles

Medidas: 3 x 3 mts.

Altura: 2,80 mts.

Altura suelo/faldón: 1,85 mts.

Tejido: Poliéster 100%. Repelente al agua.  
Con chimenea y con faldón.

Color: Crudo.

Características: PLEGABLE.

\* Funda incluida



Precio 149 €

## M7730

SET DE 4 PIEDRAS

Color: Gris oscuro.

Medidas: 47 x 47 x 5,6 cm. cada unidad

Peso: 35 Kg. unidad (total set: 140 kg.)

Nota: Este Set sólo incluye las piedras.

Precio 239 €



## M7740

INSERCIÓN PARA SUELO

Material: Hierro plastificado gris.

Medidas: 18 Ø x 61 cm.

Nota: Sólo para parasol 7520.

Precio 75 €





8005



Base de acero pintado de 6 mm de espesor. Tubo de acero pintado de 1,5 mm de espesor.  
Painted steel base 6 mm thickness. Steel tube painted 1.5 mm thickness.

ESTRUCTURA FRAMEWORK	CÓDIGO CODE
Base parasol pintado en los diferentes acabados de pintura Base parasol ended in the different ones ended of painting	8005

BASE PARASOL UMBRELLA BASE
58.59

62,5x62,5 35 0,5 17,500 1 0,120 Útil para exteriores Outdoor

8010



Parasol de aluminio pintado en blanco con 8 varillas de aluminio. Tela 100 % poliéster 200 gr/m. 3 metros de diámetro.  
Umbrella of aluminium painted in white with 8 rods of aluminium. Fabric 100 % polyester 200 gr/m. Diameter of 3 meters

ESTRUCTURA FRAMEWORK	CÓDIGO CODE
Aluminio pintado en blanco con 8 varillas de aluminio Aluminium painted in white with 8 rods of aluminium.	8010

POLIESTER POLYESTER
157.00

T 2,55 T 3 m 47 6,500 1 0,120

Útil para exteriores Outdoor

8011



Parasol de aluminio pintado en blanco con 8 varillas de aluminio. Tela 100 % poliéster 200 gr/m. 3x3 metros.  
Umbrella of aluminium painted in white with 8 rods of aluminium. Fabric 100 % polyester 200 gr/m. 3x3 meters.

ESTRUCTURA FRAMEWORK	CÓDIGO CODE
Aluminio pintado en blanco con 8 varillas de aluminio Aluminium painted in white with 8 rods of aluminium.	8011

POLIESTER POLYESTER
165.00

T 2,55 T 3x3 47 11,000 1 0,120

Útil para exteriores Outdoor

8015



Parasol de aluminio pintado en blanco con 8 varillas de aluminio. Tela 100 % textilene 2,5x2,5 metros.  
Umbrella of aluminium painted in white with 8 rods of aluminium. Fabric 100 % textilene 2,5x2,5 meters.

ESTRUCTURA FRAMEWORK	CÓDIGO CODE
Aluminio pintado en blanco con 8 varillas de aluminio Aluminium painted in white with 8 rods of aluminium.	8015

TEXTILENE TEXTILENE
220.00

T 2,55 T 2,5x2,5 47 8,590 1 0,120

Útil para exteriores Outdoor

# MOBILIARIO DE MADERA

## WOODEN FURNITURE

Sillas | Taburetes | Mesas

Chairs | Stools | Tables





Si este documento no incluye las marcas o productos que fabrica o distribuye tu empresa, notifícanoslo en [contacto@hosteleria10.com](mailto:contacto@hosteleria10.com).

Estaremos encantados de incorporarlas.