

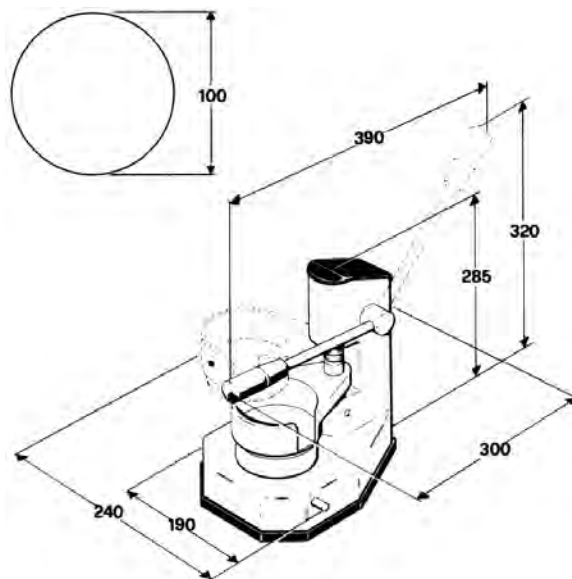









# F10



# Pressamburger

MANUAL HAMBURGER PRESS  
PRESSE-HAMBURGER MANUELLE  
MANUELLE HAMBURGERPRESSE  
FORMADORA DE HAMBURGUESAS MANUAL  
РУЧНОЙ ПРЕСС ДЛЯ ГАМБУРГЕРОВ

- IT Struttura in alluminio anodizzato - parti a contatto con la carne in acciaio inox.  
**Per hamburger ø 100 mm.**
- EN Anodised aluminium structure - parts in contact with meat made of stainless steel.  
**For hamburger ø 100 mm.**
- FR Corps en aluminium anodisé - pièces en contact avec la viande en acier inox.  
**Pour hamburger ø 100 mm.**
- DE Gehäuse aus Eloxaluminium - fleischberührende Teile aus Edelstahl.  
**Für Hamburger ø 100 mm.**
- ES Estructura de aluminio anodizado - partes en contacto con la carne de acero inoxidable - **Para hamburguesa ø 100 mm.**
- RU Корпус из анодированного алюминия - детали механизма для перемешивания мяса из нержавеющей стали.  
**Для гамбургеров ø 100 мм.**

	<b>F10</b>
	300 x 190 x 285(h) mm
	
	5 Kg
	6 Kg
	280 x 210 x 340(h) mm
	0,019 m <sup>3</sup>
	
	Confezione di cellophan da 1 Kg - 1 Kg cellophan sheets 1 Kg feuilles de cellophane - 1 Kg zellophan Blätter Envase de celofán de 1 Kg - Целлофановая упаковка 1 Kr

