

Serie
GLACE
Series



Fotografías no contractuales / Non contractual pictures.

Características técnicas y constructivas sujetas a variación sin previo aviso / We reserve the right to change specifications without prior notice.

Los datos técnicos están sujetos a posibles variaciones que serán actualizadas periódicamente en las fichas técnicas del producto, disponibles en la web.

The technical data are subject to possible variations that will be updated periodically in the technical data sheets of the product, which are available on the website.





Vitrina expositora con reserva para pastelería

Serie
GLACE
Series

CARACTERÍSTICAS TÉCNICAS



Línea modular

Línea modular, combinación de **módulos de diferentes sistemas de refrigeración**. Módulos con o sin reserva refrigerada. Ángulos y mostradores para adaptar la línea a un espacio.



Comprobación de fuga de gas

Todos las unidades condensadoras son **comprobados al 100%, en cámara de Helio** para la detección de la fuga de gas.



Iluminación

Incorporación de **iluminación LED**, llegando a **reducir el consumo energético entre un 80% y 90%** Iluminación en todos los niveles y frente para realzar los productos.

TECHNICAL CHARACTERISTICS

Modular line

Combination of **different cooling system modules**: ventilated, half-static and static. Modules with or without cooled storage. Angles and counters to adapt the line to a space.

Leak detection system

All condenser units are **tested 100%, in helium chambers** to refrigerant leak detections.

Lighting

LED lighting incorporated, **reducing energetic consumption between 80% and 90%** respect to a traditional light bulb.



VGL 15 C

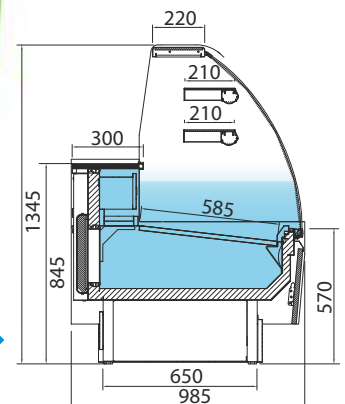

VGL C

MOD.	Potencia Power (W)	Capacidad Capacity (L)	Nº puertas Doors	Superficie Exposición (m ²)	Estantes Shelving	Compresor Compressor (HP)	LED	Consumo Consumption (kWh/24h)	Evaporación Evaporation	Potencia frigorífica Cooling capacity (W a -10°C)	Desescarche Defrost	Control	Refrigerante Coolant	De serie Standard
VGL 9 C	300	163	1	0,9	2	1/4	✓	5,1	Semi Estática Semi Static	353	Manual	Digital	R 134a	Luz estantes y decoración
VGL 12 C	380	217	1	1,2	2	1/3	✓	5,4	Semi Estática Semi Static	414	Manual	Digital	R 134a	Luz estantes y decoración
VGL 15 C	410	271	2	1,5	2	3/8	✓	6,1	Semi Estática Semi Static	464	Manual	Digital	R 134a	Luz estantes y decoración
VGL 18 C	470	327	3	2,0	2	1/2	✓	6,4	Semi Estática Semi Static	568	Manual	Digital	R 134a	Luz estantes y decoración
VGL 25 C	630	430	4	2,6	2	5/8	✓	9,6	Semi Estática Semi Static	684	Manual	Digital	R 134a	Luz estantes y decoración



Pastry display case with storage

Serie
GLACE
Series

REFRIGERACIÓN



Refrigeración

Reserva **refrigerada con ventiladores** (según modelo).
Sistema de **Condensación Ventilada**.
Sistema de **Evaporación semi estática**.

REFRIGERATION

Refrigeration system

Refrigerated storage with fans.
Ventilated condensation system.
Semi-static evaporation system.

VGL 25 C



Opcional / Optional

Puertas correderas traseras / Rear sliding doors:

VGL 9 [PUEVGL9C+]

VGL 12 [PUEVGL12C+]

VGL 15 [PUEVGL15C+]

VGL 18 [PUEVGL18C+]

VGL 25 [PUEVGL25C+]

CN Modelos neutros / Neutral models

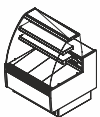

VGL 9 C

998 x 985 x 1345 mm.
Temp. +4°C/+8°C
C. Clima. 3 / 25°C
230v/1 ph/50 Hz

VGL 9 CN

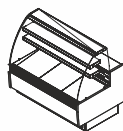

VGL 12 C

1310 x 985 x 1345 mm.
Temp. +4°C/+8°C
C. Clima. 3 / 25°C
230v/1 ph/50 Hz

VGL 12 CN

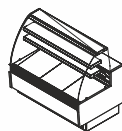

VGL 15 C

1622 x 985 x 1345 mm.
Temp. +4°C/+8°C
C. Clima. 3 / 25°C
230v/1 ph/50 Hz

VGL 15 CN

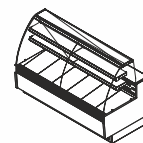

VGL 18 C

1935 x 985 x 1345 mm.
Temp. +4°C/+8°C
C. Clima. 3 / 25°C
230v/1 ph/50 Hz

VGL 18 CN

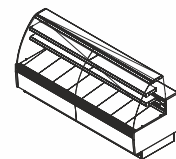

VGL 25 C

2560 x 985 x 1345 mm.
Temp. +4°C/+8°C
C. Clima. 3 / 25°C
230v/1 ph/50 Hz

VGL 25 CN







Vitrina expositora con reserva para pastelería

Serie
GLACE
Series

CARACTERÍSTICAS TÉCNICAS

- 
Control Digital
 Mayor **precisión en el sistema de control de la temperatura y humedad**. Mayor facilidad para el ajuste del intervalo de temperaturas que deseamos conseguir.
- 
Comprobación de fuga de gas
 Todos las unidades condensadoras son **comprobados al 100%, en cámara de Helio** para la detección de la fuga de gas.
- 
Iluminación
 Incorporación de **iluminación LED**, llegando a **reducir el consumo energético entre un 80% y 90%** Iluminación en todos los niveles y frente para realzar los productos.







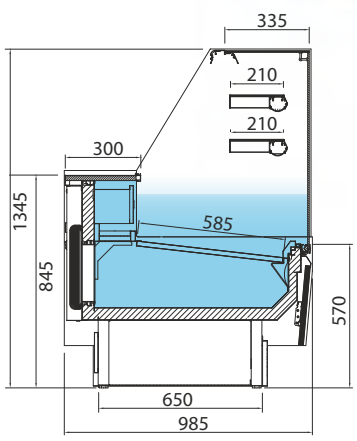





TECHNICAL CHARACTERISTICS

- Digital control**
 Higher **precision in managing temperature settings**. Greater ability to adjust of temperature ranges as per the end user's requirement.
- Leak detection system**
 All condenser units are **tested 100%, in helium chambers** to refrigerant leak detections.
- Lighting**
LED lighting incorporated, **reducing energetic consumption between 80% and 90%** respect to a traditional lighth bulb.

VGL 15 P



VGL P

- MOD.**
-  **Potencia Power [W]**
-  **Capacidad Capacity [L]**
-  **Nº puertas Doors**
-  **Superficie Exposición [m²]**
-  **Estantes Shelving**
-  **Compresor Compressor [HP]**
-  **Consumo Consumption [kWh/24h]**
-  **Evaporación Evaporation**
-  **Potencia frigorífica Cooling capacity [W a -10°C]**
-  **Desescarche Defrost**
-  **Refrigerante Coolant**
-  **De serie Standard**

Model	Potencia Power [W]	Capacidad Capacity [L]	Nº puertas Doors	Superficie Exposición [m ²]	Estantes Shelving	Compresor Compressor [HP]	Consumo Consumption [kWh/24h]	Evaporación Evaporation	Potencia frigorífica Cooling capacity [W a -10°C]	Desescarche Defrost	Refrigerante Coolant	De serie Standard
VGL 9 P	300	163	1	0,9	2	1/4	5,1	Semi Estática Semi Static	353	Manual	R 134a	Luz estantes y decoración
VGL 12 P	380	217	1	1,2	2	1/3	5,4	Semi Estática Semi Static	414	Manual	R 134a	Luz estantes y decoración
VGL 15 P	450	271	2	1,5	2	3/8	6,1	Semi Estática Semi Static	464	Manual	R 134a	Luz estantes y decoración
VGL 18 P	470	327	3	2,0	2	1/2	6,4	Semi Estática Semi Static	568	Manual	R 134a	Luz estantes y decoración
VGL 25 P	630	430	4	2,6	2	5/8	9,6	Semi Estática Semi Static	684	Manual	R 134a	Luz estantes y decoración



Fotografías no contractuales / Non contractual pictures.
 Características técnicas y constructivas sujetas a variación sin previo aviso / We reserve the right to change specifications without prior notice.
 Los datos técnicos están sujetos a posibles variaciones que serán actualizadas periódicamente en las fichas técnicas del producto, disponibles en la web.
 The technical data are subject to possible variations that will be updated periodically in the technical data sheets of the product, which are available on the website.

Pastry display case with storage

Serie
GLACE
Series

REFRIGERACIÓN



Refrigeración

Reserva **refrigerada con ventiladores** [según modelo].
Sistema de **Condensación Ventilada**.
Sistema de **Evaporación semi estática**.

REFRIGERATION

Refrigeration system

Refrigerated storage with fans.
Ventilated condensation system.
Semi-statique evaporation system.

VGL 25 P



Opcional / Optional

Puertas correderas traseras / Rear sliding doors:

- VGL 9 (PUEVGL9P+)
- VGL 12 (PUEVGL12P+)
- VGL 15 (PUEVGL15P+)
- VGL 18 (PUEVGL18P+)
- VGL 25 (PUEVGL25P+)

PN Modelos neutros / Neutral models

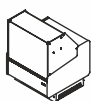

VGL 9 P

938 x 985 x 1345 mm.
Temp. +4°C/+8°C
C. Clima. 3 / 25°C
230v/1 ph/50 Hz

VGL 9 PN

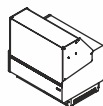

VGL 12 P

1250 x 985 x 1345 mm.
Temp. +4°C/+8°C
C. Clima. 3 / 25°C
230v/1 ph/50 Hz

VGL 12 PN

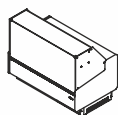

VGL 15 P

1562 x 985 x 1345 mm.
Temp. +4°C/+8°C
C. Clima. 3 / 25°C
230v/1 ph/50 Hz

VGL 15 PN

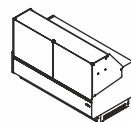

VGL 18 P

1875 x 985 x 1345 mm.
Temp. +4°C/+8°C
C. Clima. 3 / 25°C
230v/1 ph/50 Hz

VGL 18 PN

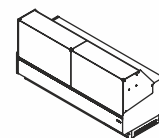

VGL 25 P

2500 x 985 x 1345 mm.
Temp. +4°C/+8°C
C. Clima. 3 / 25°C
230v/1 ph/50 Hz

VGL 25 PN





Mueble caja y decoraciones

Counter case and decorations

Serie
GLACE
Series

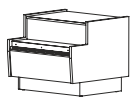

VGL 9 M

998 x 985 x 863 mm.

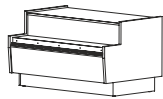

VGL 15 M

1622 x 985 x 863 mm.

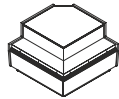

VGL 90 AAM

1205 x 1140 x 863 mm.

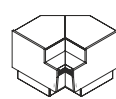

VGM 90 ACM

1045 x 766 x 863 mm.

VGL M

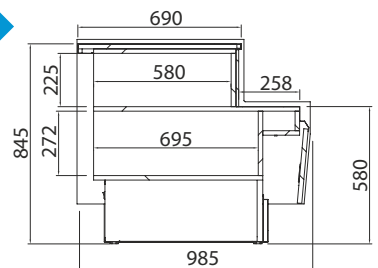



VGL 12

RAL 3020
Rojo / Red



VGL 12

RAL 4007
Violeta / Violet



VGL 12

RAL 2003
Naranja / Orange



VGL 12

RAL 5015
Azul / Blue



VGL 12

RAL 1018
Amarillo / Yellow



VGL 12

RAL 9017
Negro / Black



Decoración Standard / Standar Decorations

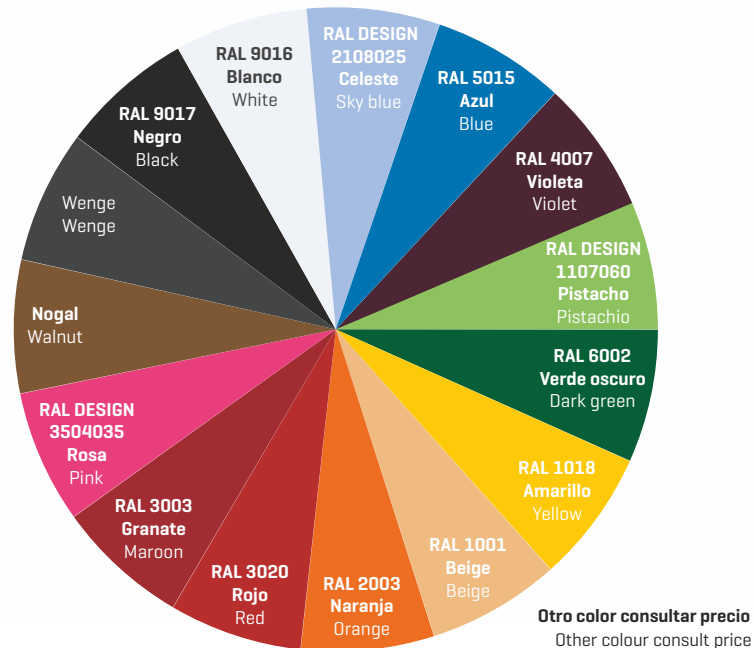

Colores fuera de carta / Colors outside of letter

Color	Tipo Type	Incremento plazo de entrega Increase delivery time	Suplemento PVP (x pedido) PVP supplement [x order]
RAL	Epoxi	+10 días laborables/ Work days	
	Líquida/Liquid	+10 días laborables/ Work days	
NO RAL	Epoxi	Consultar/Consulter	Consultar/Consulter
	Líquida/Liquid	Consultar/Consulter	Consultar/Consulter





Vitrina expositora para pastelería Pastry display case

