







Freidoras Fryers Friteuses

Sobremesa (sólo aceite)
Tabletop (oil only)
A poser (huile uniquement)

Serie J J Series Série J

Características Characteristics Caractéristiques

Modelo Model Modèle	Medidas exteriores External measures Mesures extérieures (mm)	Dimensiones cesta Basket dimensions Dimensions panier (mm)	Aceite Oil Huile	Agua Water Eau	Potencia Nominal Nominal Power Puissance Nominale		Elevador Raiser Éléva- teur	Purifica- dor Purifier Purifica- teur
					Kw	Voltaje (V)		
J-3	 230 x 425 x 305	130 x 245 x 120	4,5	-	2,2	230 V II	-	-
J-3/2	 405 x 425 x 305	130 x 245 x 120	2 x 4,5	-	2 x 2,2	230 V II	-	-
J-4	 340 x 360 x 255	ø200 x 85	4	-	2	230 V II	-	-
J-7	 380 x 530 x 430	180 x 250 x 105	7	-	3,5	230 V II	-	-
J-7GP	 380 x 530 x 430	180 x 250 x 105	7	-	5	230 V 400 V III	-	-
J-7/2	 700 x 530 x 430	180 x 250 x 105	2 x 7	-	2 x 3,5	230 V II	-	-
J-7/2GP	 700 x 530 x 430	180 x 250 x 105	2 x 7	-	2 x 5	230 V 400 V III	-	-

CARACTERÍSTICAS / CHARACTERISTICS / CARACTÉRISTIQUES

Zona fría (para depósito de residuos) que permite una fritura variada, sin alterar sabores.
Cuerpo y cuba, en acero inoxidable 18/8, **Cuba redonda o rectangular con ángulos redondeados**, para una limpieza más sencilla y eficaz.
Cesta de alambre de acero inoxidable.
Termostato de gran precisión, con piloto incorporado, indicador de resistencia en marcha.
Termostato de seguridad.
Resistencia extraíble.
Grifo de vaciado, con palanca para cierre instantáneo, excepto J-3 y J-3/2.
Modelos GP para gran producción, adecuados para frituras de patatas congeladas, mayor rapidez de recuperación.

Cold Zone where the remains are deposited. This allows alternative frying of most varied foods, without the oil taking on any flavour.
Made of stainless steel.
Round or rectangular tank with rounded angles for ensuring the possibility to be cleaned thoroughly.
Basket of stainless steel wire.
Thermostat of a top precision with a pilot lamp indicating the heater is on.
Thermostat of safety.
Heater can be removed, to clean the tank easily.
Draining cock with a lever for immediately stopping the liquid coming out, except J-3 and J-3/2.
GP Models for great production, appropriate for chips frozen and with bigger recovery of temperature.

Zone froide (récupération des résidus) celle-ci permet frites plusieurs aliments consécutivement sans pour autant mélanger les saveurs.
Fabrication en acier inoxydable.
Cuve ronde ou rectangulaire avec angles arrondis, pour une plus grande facilité de nettoyage.
Panier en fil d'acier inoxydable.
Thermostat très précis, avec voyant incorporé indiquant la chauffe de la résistance.
Thermostat de sécurité.
Resistance extractible.
Robinet de vidange, avec poignée, pour une fermeture instantanéé, pas dans les modèles J-3 et J-3/2.
Modèles GP pour des productions importantes, adaptés pour les aliments surgelés récupération plus rapide en température.

Ficha Técnica

Freidoras Serie J Sobremesa (sólo aceite)

Jemi Simply
built to last

Professional Dishwashing
and Cooking Equipment

Selva de Mar, 122-128
08020 Barcelona, España
Tel. 0034 93 308 31 54
Fax. 0034 93 303 38 73
jemi@jemi.es
www.jemi.es

Mod. J-3/2

Características

Dimensiones exteriores 405 x 425 x 305 mm.

Peso 10 Kg.

Capacidad aceite 2 x 4,5 litros.

Dimensiones cesta 130 x 245 x 120 mm.

Entrada eléctrica 230V. II.

Potencia 2 x 3,5 Kw.

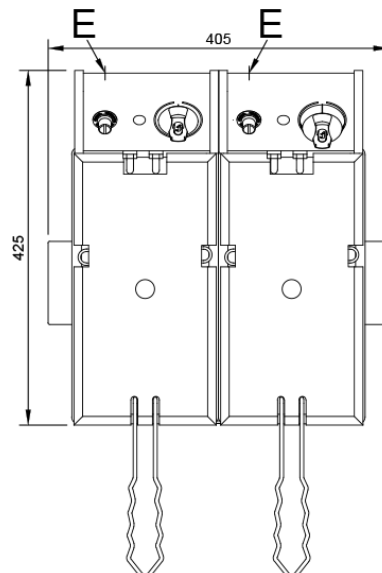
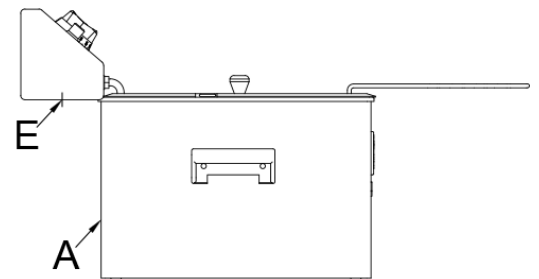
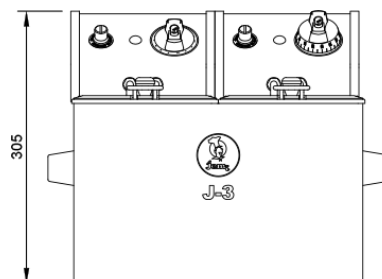

Leyenda

- A. Placa de características
(Parte trasera)
- E. Entrada eléctrica: 230V. II
Potencia: 2 x 2,2 Kw.



Ficha Técnica

Freidoras Serie J Sobremesa (sólo aceite)

Jemi Simply built to last

Professional Dishwashing
and Cooking Equipment

Selva de Mar, 122-128
08020 Barcelona, España
Tel. 0034 93 308 31 54
Fax. 0034 93 303 38 73
jemi@jemi.es
www.jemi.es

Mod. J-7/2 // J-7/2GP

Características

Dimensiones exteriores 700 x 530 x 430 mm.

Peso 32 Kg.

Capacidad aceite 2 x 7 litros.

Dimensiones cesta 180 x 250 x 105 mm.

Entrada eléctrica J-7/2 230V. II.

Entrada eléctrica J-7/2 GP 230V. III.

400V. III.

Potencia J-7/2 2 x 3,5 Kw.

Potencia J-7/2 GP 2 x 5 Kw.

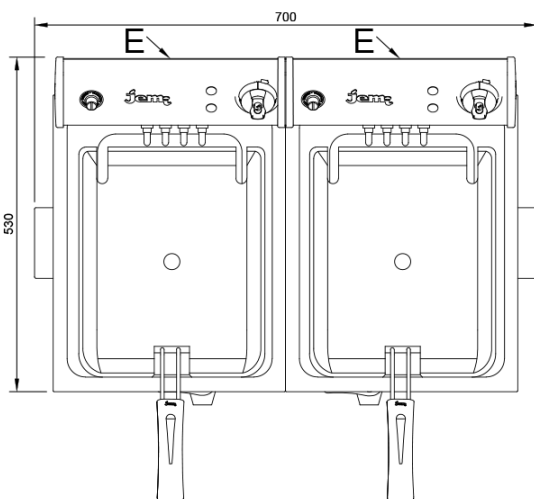
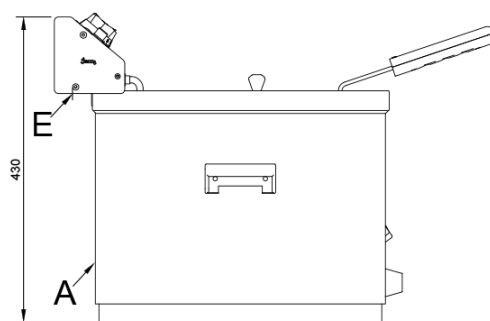
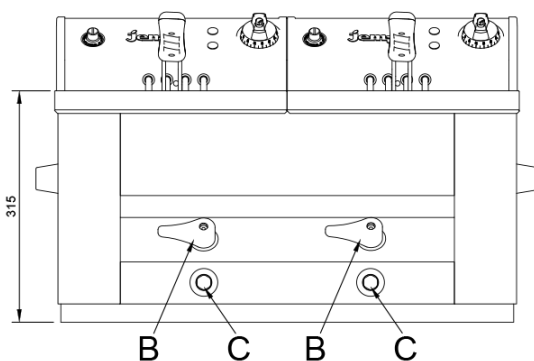

Leyenda

- A. Placa de características
(Parte trasera)
 - B. Grifo vaciado.
 - C. Desagüe.
 - E. Entrada eléctrica: J-7/2 230V. II
J-7/2 GP 230V. III
400V. III
- Potencia: J-7/2 2 x 3,5 Kw.
J-7/2 GP 2 x 5 Kw.

